

Practical Computing

Computer Fair
The Midland
Personal computers
Home computing
Street hardware systems
£1 off admission: voucher inside

85p May 1984

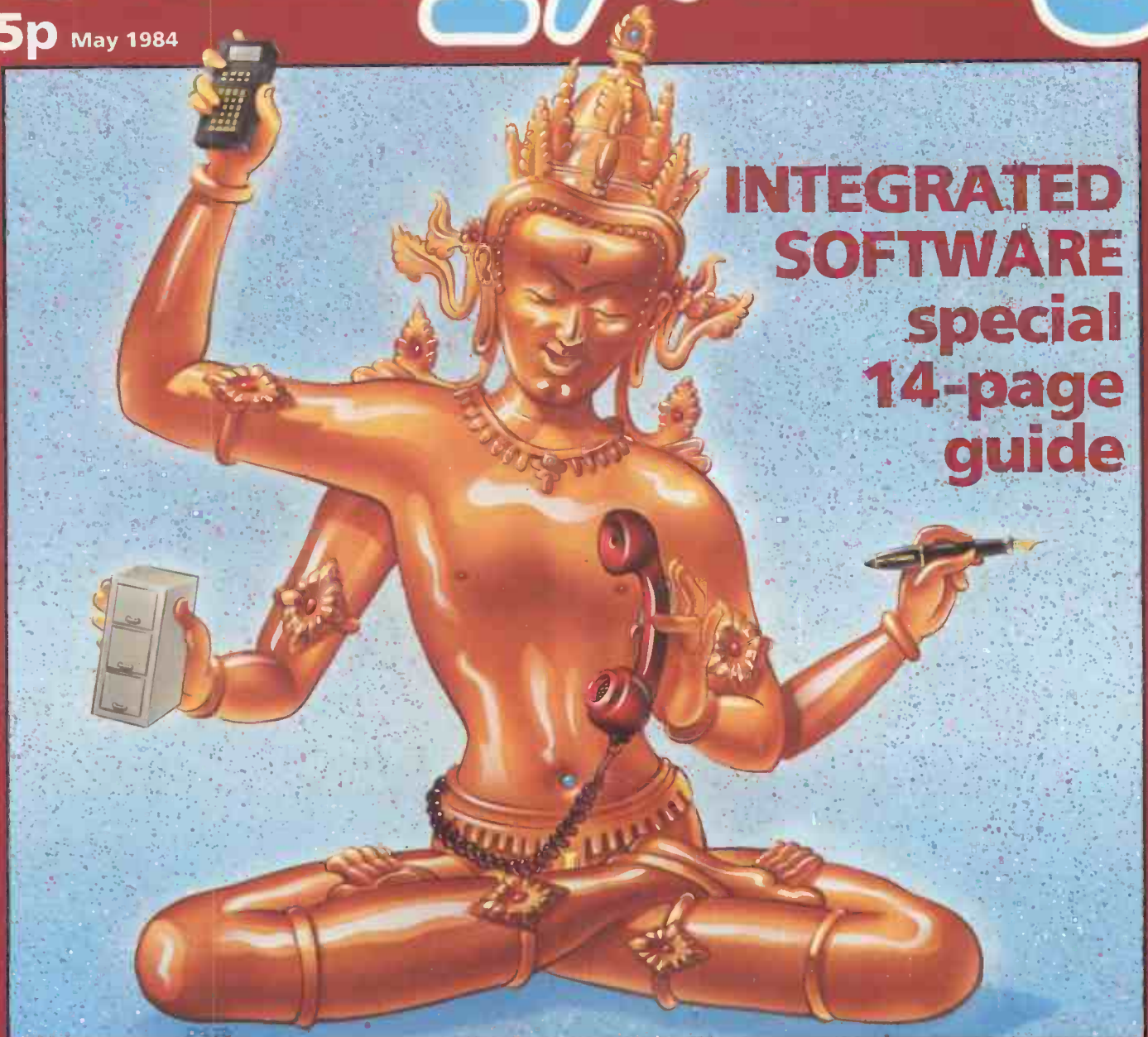

**INTEGRATED
SOFTWARE
special
14-page
guide**

**Reviews – Grid Compass, Sharp PC-5000
Olivetti M-24, Touch Screen HP 150
BBC Graphics ROM and telesoftware add-on
Logo for Atari, Commodore 64, Spectrum**

Denmark DKr34.50, Greece Dra 245, Holland DFL8.50, Italy L4100, Spain Pts 360, Switzerland SFr7.40, Germany DM8.50, France Fr32.60, Canada C\$4.50, Australia A\$3.00, Singapore M\$6.35, USA \$3.95(D72162)

The right software for your application from



Authorised Dealer
Service Centre
System Consultancy

COMPUTECH



COMPUTECH FINANCIAL ACCOUNTING PACKAGES

Payroll **£375**
 Invoicing and Stock Recording **£295**
 Sales, Purchases and General Ledgers **each £295**
 Also costing and group consolidation

COMPUTECH UTILITIES DISK

for reliable error checking copying, diskette scan, interpret and patch, etc **£20**
 VisiCalc, Applewriter and other Apple software (Prices on request)

COMPUTECH CHAIN MAIL

A mailing merging document processor which may be used with text files, including random files and Applewriter 1.1 binary files **£45**

COMPUTECH GRAPHICS DISK

for printing Apple pictures and graphs on Epson and Microline (free with printers purchased from Computech) **£30**

COMPUTECH TERMINAL UTILITIES

Apple to Apple and Apple to mainframe **from £130**

COMPUTECH hardware...just plug it in and go!

switches and jumpers provide hardware options without soldering



DIPLOMAT VIDEO DIGITISER

store a frame from video camera in a fiftieth of a second, process and print — for Apple II **£195**
 for APPLE II/e, including 64K Extended 80 Column Card **£345**

DIPLOMAT PARALLEL Interface

£80

DIPLOMAT SERIAL COMMUNICATIONS Interface

£85

DIPLOMAT RAM 16 Memory Expansion

£95

DIPLOMAT CLOCK/CALENDAR

£80

LOWER CASE Character Generator with Applewriter 1.1,

enhancements **£50**

MICROMUX Data Exchange (Max 16 Ports)

from £850

MATRIX PRINTERS, Microline and Epson with

graphics and up to 200 cps **from £222**

MICROLINE Optional Character Generator

£15

DAISY WHEEL PRINTERS, Olympia, Qume, Ricoh

from £798

Prices exclude VAT, Carriage and Packing

For full details phone for data sheets and a FREE demonstration

COMPUTECH SYSTEMS

168 Finchley Road, London NW3 6HP. Tel: 01-794 0202

LIST

PRACTICAL COMPUTING

MAY 1984

>NEWS

13 HARDWARE NEWS
Computers' 128K Lynx with CP/M, and a second processor for the BBC Micro — but still no Z-80.

21 SOFTWARE NEWS
Foreign-language learning takes off, while Microsoft gives Basic programmers multiple windows.

45 IBM PC NEWS
IBM makes more profits, aims to stop pirates, and announces its own portable version of the PC.

>REVIEWS

47 THE SALES EDGE
Can a software package help a sales team? We report on the first of a new range of American packages that give you the edge.

78 NEW OLIVETTI M-24 MICRO
A special review of a new IBM PC look-alike in prototype from Europe's leading computer manufacturer.

84 IN TOUCH WITH THE HP 150
Hewlett-Packard's innovative desktop micro with touch screen operation, examined by Glyn Moody.

88 BBC GRAPHICS ON A ROM CHIP
Neville Maude tries the new Computer Concepts ROM which adds extra graphics commands.



90 GRID COMPASS
The transportable that went on the Space Shuttle — the slickest, sleekest model yet.

94 SHARP PC-5000
Chris Bidmead reports on the stylish 16-bit bubble-memory portable — is its beauty more than skin deep?

100 LOGO — GROUP REVIEW

Boris Allen surveys versions of Logo for popular micros — including the Atari, Commodore 64 and Sinclair Spectrum.

146 AMAZING GAMES FOR THE SPECTRUM
Spectrum games keep improving, as Jack Schofield discovers.

171 BBC BOOKS
Simon Beesley's selection of recent books for the Acorn/BBC machine.

>INTEGRATED SOFTWARE

125 AN INTRODUCTION TO INTEGRATION
What is really meant by "integrated" software.

126 SOFTWARE IN SUITES
Chris Bidmead surveys some well known software families.

128 SINCLAIR QL
The QL's integrated software is one of its major attractions. Glyn Moody tries it out.

130 ALL-IN-ONE PROGRAMS
From Lotus 1-2-3 and The Incredible Jack to Open Access and Symphony — Jack Schofield surveys the booming all-in-one market.

132 INTEGRATED ENVIRONMENTS
For true integration, software meets hardware, as in the Xerox Star, Apple Macintosh and other state-of-the-art micros.

136 INTEGRATED ACCOUNTS
Integration is all-important in the down-to-earth field of accounts packages, as Mike Lewis explains.

>FEATURES

48 HOW TO HANDLE DATA FILES
Paul Myerscough explains the essentials of efficient data handling, with Microsoft program listings for the IBM PC.

102 TELESOFTWARE PROGRAMS ON TV

An introduction to BBC TV's Ceefax-based service and the Acorn/BBC Teletext system.

104 LINEAR PROGRAMMING

The Simplex algorithm and its use in planning production, with a program in Microsoft Basic by Adrian Hill.

107 COMMODORE 64 GRAPHICS — PART 3

Boris Allan completes his selection of routines for graphics on the Commodore 64.

111 HOME-INTO-BUSINESS MICRO SURVEY

Can a home micro really have business uses? We look at six popular machines to see how useful they are, and how to upgrade them.

116 CLEAN UP YOUR POWER SUPPLIES

Chris Naylor on how to ensure glitch-free computing pleasure.

122 FICTION

Take time out with L S Murray's Starfiend.

>REGULARS

5 EDITORIAL — COMING SOON . . .

Why complain about delays to the QL when everything is late?

7 FEEDBACK

Piracy and back-up copying, correspondence and advice from readers.

29 CHIP-CHAT

DEC fights back with the Micro Vax.

35 SOFTWARE WORKSHOP HASHED TABLES

Mike Lewis with more invaluable advice for programmers — this month, hash coding.

155 OPEN FILE

See the separate contents page for details of this month's free software for the Apple, BBC, Commodore and other micros.

181 LAST WORD EDUCATION

Sixth-form student Jon Lansdell presents a user's-eye view.

The world's leading micro database package can now give you even more.

dGRAPH™

The powerful graphics partner for dBASE II

Introducing a unique database graphics system that enables you to produce high

quality bar, line and pie bar charts without any specific programming knowledge. Everyone can now produce graphs in minutes with dGRAPH: managers, staff and secretaries.

The AUTOGRAPH feature

The Fox & Geller dGRAPH system couldn't be simpler – just select the graph you require, and choose the dBASE data, let AUTOGRAPH do the rest. Whether you want to automatically load your dBASE data, compute scales, draw grid lines or you need more advanced features such as 'zoom-in' capability, or combination bar charts, AUTOGRAPH can cope... all at the push of a button.

The flexible time saver

The scope for plotting data is limitless with dGRAPH. Use dGRAPH to extract data from dBASE II so that you can produce high quality charts. You can even graph the difference between two fields, and create graphs showing averages and percentages. And, in addition, there's a calendar feature to allow you to 'build' data by day, month or year. Think about how much time you spend drawing sales graphs and comparison charts – think how easy it could be from now on.

Talk to your local dealer now and feel confident about presentations in the future.

● Circle No. 102

DEALERS – Contact Fox & Geller or one of these distributors for more details

Softsel
Tamsys
Pete & Pam
MPI
Soft Option
ACT(Pulsar)

01-844 2040
(Windsor) 56747
01-769 1022
01-591 6511
(0476) 860171
021-455 7000

Midlectron
Software Ltd
Xitan
Tradesoft
Ferrari

(077382) 6811
01-833 1173
(0703) 871211
01-627 1800
01-751 5791



FOX & GELLER

Fox & Geller (UK) Ltd, 17 Wigmore Street, London W1. Tel: 01-580 5816.

Practical Computing

EDITORIAL 01-661 3609

Editor Jack Schofield
Assistant Editors Ian Stobie, Glyn Moody
Art Editor Stephen Miller
Production Editor John Liebmann
Sub-editor Carol Hammond
Editorial Secretary Sue Jordan
Consultants Chris Bidmead, Peter Laurie

ADVERTISING 01-661 3612
Advertisement Manager Ian Carter 01-661 3021
Assistant Advertisement Manager Paul Braybrooke 01-661 8626

Advertisement Executives
Desmond Bond 01-661 3468
Lynne Brennan 01-661 8100
Mike Crimp 01-661 8425
Chris Markiewicz 01-661 3633

Advertisement Secretary Janet Thorpe
Midlands office: David Harvett 021-356 4838
Northern office: Geoff Aikin 061-872 8861

PUBLISHING DIRECTOR Chris Hipwell

Published by Electrical Electronic Press, Quadrant House, The Quadrant, Sutton, Surrey SM2 5AS. Tel: 01-661 3500. Telex/grams 892084 BISPRS G.

Distributed by Business Press International Ltd, Quadrant House, The Quadrant, Sutton, Surrey SM2 5AS.

Subscriptions: U.K. £13 per annum; Overseas £19 per annum; selling price in Eire subject to currency exchange fluctuations and VAT; airmail rates available on application to Subscription Manager. Business Press International Ltd, Oakfield House, Perryman Road, Haywards Heath, Sussex RH16 3DH. Tel: 0444 459188.

Printed in Great Britain for the proprietors Business Press International Ltd by Eden Fisher (Southend) Ltd, Southend-on-Sea. Typeset by Centrepoint Typesetters, London EC1.

© Business Press International Ltd 1984

Would-be authors are welcome to send articles to the Editor but PC cannot undertake to return them. Payment is at £35 per published page. Submissions should be typed or computer-printed and should include a tape or disc of any program. Hand-written material is liable to delay and error.

Every effort is made to check articles and listings but PC cannot guarantee that programs will run and can accept no responsibility for any errors.

Ready soon

AN INCREDIBLE NUMBER of people have phoned to ask if we would like a review of the Sinclair QL. Most of them people who really ought to know better. The conversation continues, "Have you actually got a machine, then?" And the answer comes back, "No, but I'm expecting it by the end of *****." Fill in February, March, April, May, etc. according to taste.

Like most magazines we reserved a QL immediately after its launch, but with no real expectation of seeing a machine in less than three months. It never occurred to us that anyone involved with the micro industry would take seriously the idea that any product, not just the QL, would be delivered in "28 days".

It is obviously the case that the micro industry as a whole has a different concept of time from everyone else. "The product is in stock" means you can get one in about a fortnight to six weeks. "It is being delivered now" means you might get one within 28 days. "They are coming off the production line" means two months. "We are just starting pilot production" means three to six months. "We have been surprised by demand" means six months to a year.

Anyone who talks in these terms is at least seriously considering the delivery of the final product. That is a good sign. It means it may well be worth placing an order simply to be somewhere near the front of the queue. Even when products are in full production there can be long delays before your order is filled. There were long delays on the Sinclair Spectrum, and apparently some people waited nine months to a year to receive their BBC Model B.

What is not acceptable is the advertising of products which are unlikely to be delivered, either within a feasible time scale or, in some cases, ever. For example, way back in 1981 there must have been many people who were impressed by the BBC Micro's much-vaunted "second processor" option. We were promised a 6502 and a Z-80 and, later, even a 16032. At the time of writing we have just been invited to the press launch of the 6502 second processor. That is more than 2½ years after it was included

on the BBC Microcomputer System Information Sheet G2, a leaflet which nowhere mentions the manufacturer, Acorn.

In October 1982 we were promised a Z-80 add-on for the Commodore 64 which, we were told, would provide CP/M. Now, some 18 months later, we are told "there are some in the warehouse", and we expect ours to arrive soon.

Also at the end of 1982 we were playing with the new Computers Lynx micro, and we were promised CP/M for that. Again, the press launch took place in March 1984. When real people will get real systems is still a matter for speculation.

It is also a fact of computing life that when products arrive they often fail to live up to the promotional hoop-la. For example, the BBC Model B is a wonderful machine, but it would have been even nicer if it had been delivered from the start with OS 1.2 and Basic 2, not to mention a really good DFS or DOS. Or take today's Atmos, with its real keyboard and debugged Basic: it is everything the Oric 1 should have been a year ago but wasn't.

The point is not to be critical of a few firms, because many are guilty. The entire micro industry is rushing ahead at a breakneck pace, and it is only to be expected that partly baked products will be released, that the marketing boys will always rush ahead of production, and that production will, initially, produce mainly problems.

That is why there is still a huge market for micros that work and are supported by masses of reliable software. Typical products include boring old eight-bit micros running CP/M, established sellers like the 1977 Apple II and 1979 Atari micros, and now the IBM PC and the BBC Model B, both from late 1981 — even at less than cutthroat prices.

Notwithstanding the genuine excitement and interest generated by new machines and new software — which thrills us as much as anyone else — there is a bottom line which is what it is really all about. That is — and it is no coincidence — also the name of this magazine: practical computing.

5 Years ago ... Steve Wozniak: What the world is really looking for is the machine with the best video resolution and the best colour possible. When you think about it, all it is is RAMs. It's not more complicated, it's just how much RAM you want to spend money on — and RAM is getting so cheap. Practical Computing: What do you think the next generation of computers will have? For example, what do you consider the minimum RAM content of any personal computer? SW: Well, 16K is our minimum now. No-one in their right mind would order a 4K Apple. Disc or operating systems call for quite a bit of RAM. The TRS-80 and the Pet are in a rather difficult position because they were not really designed for upgrading like that to a helpful memory capacity, but Apple II was designed to plug 48K into the main board. That was unheard of. I think we can see the time come when we'll want more than 64K and that's going to be a real problem with some of the current microprocessors. Steve Wozniak Interviewed in PC Volume 2 Issue 5

NEW

SANYO

16 BIT BUSINESS MICRO FROM ICARUS

FROM ONLY

£749

MBC 550
Single
5 1/4" floppy
disc drive
£749 (+VAT)



The new Sanyo 16 BIT small business micros... with tremendous potential for businesses of all sizes.

- 16 BIT 8088 CPU with powerful MS-DOS operating system
- 128K RAM expandable to 256K
- Centronics compatible parallel printer port
- Compact desk top design with detachable keyboard
- Optional high resolution green phosphor or colour monitor

INC. **FREE** SOFTWARE

MBC 550

MS-DOS BASIC WORDSTAR CALCSTAR

MBC 555

MS-DOS BASIC WORDSTAR MAILMERGE CALCSTAR INFOSTAR

MBC 555
Twin
5 1/4" floppy
disc drives
£999 (+ VAT)



EXTRA FROM ICARUS

- ★ Integrated sales, purchase and nominal ledger accounts package with MBC 555
- ★ Choice of 160K (standard), 350K or 700K discs
- ★ 10 MB external hard disc
- ★ The backing of the nationwide Icarus dealer network for application advice and installation

SEE SANYO



THEN DECIDE... ICARUS

Full details of the new Sanyo micros on request.

ICARUS

ICARUS COMPUTER SYSTEMS LTD, Deane House, 27 Greenwood Place, London NW5 1NN. Tel: 01-485 5574. Telex: 264209

● Circle No. 103

Piracy and copying

I WAS DELIGHTED to see your editorial on the subject of "Piracy, again" in your March issue.

I am not usually a writer of letters to the editor but was so very distressed by *PCW's* attitude that I felt impelled to write to them, as follows:

I cannot say how deeply I, and I am sure many others, regret the article on page 13 of February's *PCW*. Far from helping "the fight against software piracy", you have weakly and cravenly caved in to what amounts to a denial of the reasonable rights of purchasers — and incidentally, since the matter was settled out of court, it does not create a legal precedent.

I am completely opposed to software piracy, as to any other defrauding an author of the fruits of his labour: however anti-copying devices are a totally unreasonable answer and should be banned. If I buy a painting, I am entitled to reframe it, to photograph it for insurance purposes or private study, and even to modify it — what I cannot do is to make and sell prints of it.

If I buy software, I should have an absolute right to copy it for backup purposes, to modify or configure to my particular needs, and to make it more convenient or faster to load or use.

I am not personally interested in games, but I would be outraged at the suggestion that, having paid out money for cassettes, I could not resave a selection on to disc. This nonsense will hardly, for example, help the sale of Sinclair Microdrives when the most obvious use is to resave a selection of games cassettes for easy selection and fast loading.

You have a duty to your readers, who are the customers of your advertisers, and the only reason the latter are in business, to ensure that purchasers receive value for money, which includes being able to make use of the software they buy in any way that does not infringe the reasonable intellectual property rights of the authors.

In a business application, an uncopyable program could well be in breach of the Sale of Goods Act as "unfit for purpose" if good user practice required the ability to make copies. Either software protection should be made illegal, or software houses should be required by law to exchange protected copies for unprotected on the purchaser signing a licence agreement the fee for which, to avoid oppression of customers, should be set by law at not more than 50 percent of the purchase price of the original program. In addition I think you should refuse software advertisements unless they state whether or not the programs are protected and, if they are, the terms on which copyable versions for proper uses are available.

I am writing this on a Commodore 4032 using that excellent program *Simply Write* from *Simple Software*. This program is unprotected which has (a) enabled me to make several valuable enhancements; (b) place my working copy on a disc with several utilities such as a printer configuration program, *Owen Murcott's Tidy* program to enable files to be reorganised, and *Mark Atherton's Auto* for fast program selection and loading by menu, both public domain; and (c) have on the same disc the files on which I am working. This has enabled me to use a single drive without the inconvenience and damage by continually swapping discs as I often during a working session need to load another program and then reload the word processor. It also means that as I work at both home and the office, with duplicated setups, a single disc can transport the entire suite of programs and files I have made up. All this because the program is not protected! These techniques are standard for CP/M and it is grossly unjust that users should be denied their use.

I therefore hope you will rethink your position, which is retrograde and harmful to the reasonable rights of those who have paid for software and have a right to make full proper use of it.

The Acorn cassette-to-disc copying service — see page 21 of your March issue — again begs the point as apparently the user would have one disc, 99 percent unused, per cassette. To me, one of the joys of going over to disc with my CBM system was to be able to place 20 or more programs on a single disc, with programs to select and rearrange them.

A massive lobby is being created to enforce software protection against the reasonable and proper interests of users. I am delighted to know that you will be continuing to redress the balance.

William Lyons,
London NW3.

● **The Editor adds:** *Practical Computing* is against piracy. We strongly oppose the selling of copies of copyright programs, and will never countenance or support it. However, the provision of a backup copy of a program, or the facility to make a working copy so that the master disc can be kept as backup, is essential to all serious computing. It is also important to be able to optimise the use of a program, either by transferring it to a floppy or to a hard disc. For these reasons we regard copyable software as inherently superior to non-copyable software. Systems which allow backup copying but prevent piracy would seem to offer the best solution.

Operational compatibility

ON PAGE 13 of your March issue you featured the announcement of the ITT Xtra in which you noted that the Xtra was "operationally compatible" with the IBM PC and wondered what it meant.

The term was devised by Future Computing Inc. of Richardson, Texas, which has undertaken a vast amount of research in this field and has defined various levels of compatibility with the IBM PC. These levels vary from incompatible machines, such as the ACT Apricot and the DEC Rainbow 100, through to the top level of compatibility — operationally compatible machines such as the Compaq portable and the ITT Xtra.

Compatibility levels are defined by narrative and hardware/software features. They are, briefly, as follows for operationally compatible machines: uses 8088 micro-

processor; runs top IBM PC/XT labelled software; uses IBM peripheral cards; can read/write IBM diskettes both SSDD and DSDD; has the same user interface for documentation, display keyboard and sound.

I hope this clears up any confusion in readers' minds.

Stuart Goldberg,
STC Business Systems Ltd,
Sidcup,
Kent.

Random numbers

IN REPLY to John Wellsman's comments in the January issue about pseudo-random number generation on the Epson HX-20, I too have had problems with repetition of lists of pseudo-random numbers.

As stated in his article, by using the *Randomize* function, the sequence of pseudo-random numbers begins at a different

(continued on next page)

Our Feedback columns offer readers the opportunity of bringing their computing experience and problems to the attention of others, as well as to seek our advice or to make suggestions, which we are always happy to receive. Make sure you use Feedback — it is your chance to keep in touch.

(continued from previous page)

position in the list, but it will be the same sequence of numbers every time the program is run. Clearly this is no good for most applications which demand the use of the pseudo-random number generator.

However, as the manual states, the argument for the Randomize function can be an expression. One expression which will give a different value every time it is executed is the Time\$ function, so by combining this function with the Randomize function the pseudo-random number list can be generated apparently at random.

```
10 RANDOMIZE (VAL(RIGHTS
(TIME$,2)))
```

will effectively choose any one of 60 different lists, but if that is not variation enough then the expression can be expanded as follows:

```
10 RANDOMIZE (VAL(RIGHTS
(TIME$,2))*VAL(MIDS
(TIME$,4,2)))
```

which will give an apparently random selection from 3,600 different lists.

William Hughes,
Garston,
Liverpool.

A small step for Sinclair?

IN OUR UNIVERSE, the smallest finite change in energy which a physical system can experience is called a quantum jump, or leap. Fortunately, the quanta involved are so very tiny that their finite size is not noticeable except for sub-atomic processes. Can any reader suggest a reason why, given this background, the term "quantum leap" is used colloquially to imply a very large change indeed?

John Shade,
Letham,
Angus.

Ben Rogers

IN SEPTEMBER 1980 *Practical Computing* published an article entitled "Fast Fourier Transforms" by Ben Rogers. Could Mr Rogers please contact the Editor as we can't find his address.

Apple interfaces

THOSE INTERESTED in the Apple Operations article on page 86 of the February issue may appreciate this tip from a reader, who has pointed out that inductive effects from a relay coil can destroy a transistor. A diode connected over the relay coil prevents this — see figure 1. A 1N4001 with the end marked with a band connected to +9V and the other end connected to the transistor's collector terminal will do the job.

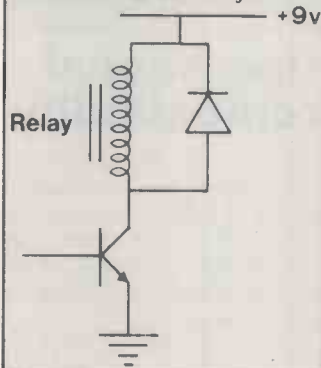

Jargon confusion

ALL WRITERS like to use jargon because it makes the author appear an expert, but it is small wonder that it confuses beginners. The assumption is that everyone will understand the meaning of the jargon

and that the terms are unambiguous. Yet if you come from a different sphere of interest, the terms can actually have different meanings.

Electronics and computer enthusiasts will assume that A/D means analogue to digital and D/A means digital to analogue but a photographer will know that D/A means daylight to artificial and few cine photographers would be without their A/D filter as it is vital to get good pictures in daylight. You can go further into these dual meanings: TTL to a photographer stands for "through the lens" but electronics engineers use the same letters for transistor-transistor logic.

None of these beats the confusion that I felt on asking for a monitor. I was asked EPROM, ROM, tape or disc? On describing it as "like a TV that won't work", I was told that I wanted a VDU, "It's no good just asking for a monitor". The salesman then picked up the telephone and asked the warehouse: "Got any monitors in stock?"

This is only part of the confusion for a beginner. I was interested in an electronic typewriter. I could have picked one up and taken it home with every expectation of it working. However, I was told that a computer can be used as a word processor, which is much better. I was told in one shop that a word processor costs thousands and another one offered me one for £5. I ordered one that cost £35 and allowed me to do all sorts of wonderful things on the screen. However, nobody explained that I needed a printer which cost more than the typewriter which I had been considering.

Derek Trayler,
Hornchurch,
Essex. ☐

Waiting. . .

```
10 GREETING$="DEAR JACK"
15 ISSUE$="DECEMBER":SUBJECT$="
COMPETITION, JULY"
20 ITEM$="SMALL CONSOLATION PR
IZE":DISAPPOINTMENT=5000
25 FOR TIME=1 TO 20:PATIENCE=P
ATIENCE-50:NEXT TIME
30 FOR DAYS=1 TO 45
35 IF PEEK(LETTERBOX)=PRIZE TH
EN DISAPPOINTMENT=0
40 PRINT "SORRY TO BOTHER YOU,
BUT"
45 PRINT "I HAVEN'T HAD THE SM
ALL CONSOLATION PRIZE"
50 PRINT "THE DECEMBER ISSUE A
DVISED HAD BEEN SENT."
55 NEXT DAYS
60 IF DISAPPOINTMENT<>0 THEN D
ISAPPOINTMENT=DISAPPOINTMENT+5
000:GOTO 25
65 OPEN #2, "PRIZE"
70 IF PRIZE<3 THEN POKE PRIZE,
ANYWAY
75 IF PRIZE>25 THEN MYESTIMATI
ON=MYESTIMATION+JACK
80 PRINT "THANKYOU FOR YOUR ";
ITEM$
85 IF PEEK(LETTERBOX)=THEN INT
(5.5):REM EXTRACT DIGIT
90 CLOSE PRIZE
95 NEW
100 REM ROGER PEACOCK, THETFOR
D, NORFOLK
```

• The Editor replies:

```
EDITOR:CHECK PROGRAM
REPORT:PROGRAM CHECKS OUT
EDITOR:CHECK CHEQUES
REPORT:CHEQUE CHECKS OUT
EDITOR:CHECK CHEQUE SENT
REPORT:ERROR! ERROR!
EDITOR:REPORT
REPORT:MISLAID ADDRESS
EDITOR:POST TO ADDRESS
REPORT:DONE
```



NOW WITH 16-BIT MASTER PROCESSOR

Mini's too expensive

For a multi-user business system expandable to 16 screens you used to need a sizeable mini, say from **DEC** or **Burroughs**, with a hefty price-tag for hardware and software, with long time-scales.

Micro's too small

Micros, like **Altos**, **Sage** and **Rair**, 8-bit or 16-bit, are doomed by CPU degradation, being based on the time-sharing principle. PCs, like **IBM** and **Apricot/Sirius**, just aren't in this league at all, networked or otherwise.



SuperStar multi-user system...

...is just right

SuperStar is a multi-processor system in which up to sixteen 16-bit processors, each with up to 1Mb RAM, are integrated in an attractive desk-top unit. All users can work at full speed in genuine multi-user, multi-tasking mode with full file/record locking and spooling.

At half the price of a mini and a give-away price for the world's largest selection of software, **SuperStar** is just right for any multi-user application.

£5975 buys a complete 2-user high-performance system, with 10Mb winchester and VDUs. Additional users for £995 each, including VDU and processor.

Supports all **CP/M** and **MS-DOS** programs as well as the wide range of **BROMCOM** genuine multi-user software.

BROMCOM

417-421 Bromley Road, Bromley, Kent BR1 4PJ
Tel: 01-697 8933 Telex 896691 TLX1RG

OEM, Dealer and Overseas enquiries are welcomed.



SuperStar is a trade mark of Bromley Computer Consultancy. CP/M is a trade mark of Digital Research. MS-DOS is a trade mark of MICROSOFT.

SuperStar-16 has a 16-bit Master Processor which runs IMPOS (BROMCOM designed true 16-bit controlling operating system). IMPOS supports CP/M, MS-DOS and shortly Xenix in slave processors in any combination and it is fully upward compatible with ACTION DPC/OS, Televideo MmmOST and TurboDOS.

THE ACT SIRIUS SX

10 Megabyte

256K RAM

£3995-00

Built with a commitment to quality, the new Sirius SX is the latest addition to the 16-bit ACT Sirius family. And it's available now, at a complete system price of only £3,995. With 256Kbytes of internal RAM and an integral 10Mbyte Winchester hard disk, it is extremely powerful and extremely fast – ideal for those large volume business applications which previously required much more expensive minicomputer equipment.

The Winchester drive is the heart of the machine, greatly improving on both the speed and data integrity of floppy-based systems. Average access time is reduced to just 134 milliseconds while the average transfer rate is an astonishing 104,000 characters per second.

Like all the Sirius range, the Sirius SX is backed by the strength and resources of ACT. The Pulsar range of true 16-bit application software for accounting, planning and word-processing; over 1,000 hardware/software add-on products; ACT Training Centres open to all; nationwide field service; a full range of printers and consumables. And the most complete and professional dealer network in the United Kingdom.

Sirius prices start at just £2,195 for a dual floppy drive system with 1.2Mbytes and £2,695 for the double-sided floppy drive version offering 2.4Mbytes.





ACT SIRIUS SX : THE FACTS

WINCHESTER SUBSYSTEM

10.6Mbyte (formatted) 5 1/4 " integral Winchester drive
Twin platters
134msec. average access time
Intelligent disk controller
DMA interface to system memory
Multiple operating systems
User configurable

GENERAL SPECIFICATIONS

256Kbytes RAM
Intel 8088 16-bit processor unit
1.2Mbyte double-sided floppy disk drive for back-up
800x400 pixel, high resolution graphics
Multiple operating systems
Parallel/IEEE 488 port
2xRS232 asynchronous/synchronous ports
Internal user port

For more information on the new ACT Sirius SX, clip the coupon and return to:



ACT (UK) Limited

FREEPOST
Birmingham B63 1BR
or call: 021-501-2284

Please send me further details of the new Sirius SX

Name _____

Position _____

Company _____

Address _____

Tel: _____

● Circle No. 105

PC5/84



With the vast amount of software running in so many widely differing fields, the Comart Communicator has already proved itself ideal for both software and hardware OEM's.

You'll find it at work ensuring that the field doctor in Kenya has the right medicines on board; the multiple caterer never runs out of buns and burgers and the dairy herd receives a balanced feed to achieve optimum milk yields. It's also doing jobs in a host of other areas — you'll find a few other examples at the foot of this page.

The most impressive thing about the Comart Communicator is its sheer adaptability. Modular in concept, it can be expanded both inside and out. In under three years it has become a complete family of compatible, fully expandable microcomputer systems with a range of no less than 20 models — including single-user, multi-user and multi-processing systems. There's a choice of floppy and hard disk storage capacities with up to 1 megabyte of main

memory plus cartridge tape and 8" diskette sub systems.

The Comart Communicator can support the widest possible range of operating systems including 8 & 16 bit versions of CP/M, MP/M, MS-DOS, CP/NOS, CP/NET and BOS together with IBM and ICL mainframe communication protocols.

Because every model can be readily configured, the Communicator affords a greater flexibility in the final choice of system, making it suitable for a multitude of specialist applications. And by making use of industry standard S100 Boards, existing and future models can be enhanced and upgraded to take account of new applications.

Such flexibility ensures that the Comart Communicator is unlikely to become obsolete. So software based on the Communicator can be planned with the certainty that the hardware will be around in the future, protecting your possibly substantial investment in development time.

The Communicator is renowned for its rugged reliability making it ideal for stressful environments. It's backed by a 12-month warranty and Comart have also met the stringent CCTA requirements. Also working for you are the resources and reputation of Comart as a major force in UK microcomputer development, with their innovative R & D team plus the support and back up of a speedy nationwide service organisation. And of course dealing with a British manufacturer you have direct access to our product support specialists for technical assistance.

What's more, you'll find the price of a Communicator very competitive. So if you're a system builder, OEM, software house or an end user looking for a solution for a specialist application, post the coupon for further details.

comart

Comart Limited, Little End Road, Eaton Socon, St. Neots, Huntingdon, Cambridgeshire PE19 3JG.
Tel: (0480) 215005. Telex: 32514 Comart G
A member of the Comart Group of Companies

The number of specialist software packages running on the Comart Communicator surprised even us.



COMART COMMUNICATOR SPECIFICATIONS

	CP100 Series Systems	CP1000 Series Systems
Microprocessors:	8 Bit Z80A (1 to 6)	16 Bit 8086
Memory:	64K-512K bytes	256K-1M byte
Storage:	390K or 790K byte diskettes 5M or 20M byte hard disks	390K or 790K byte diskettes 5M or 20M byte hard disks
Operating Systems:	CP/M, MP/M11 & CP/NET	CP/M86, MP/M86, MS-DOS
	Multi-processor, 1 to 5 users	1 to 8 users
Features common to both CP100 & CP1000 Series Systems		
Keyboard/Display:	105 Key, detached 14" green screen, removable.	
Expansion:	Internal - S100 cards, mainframe communications & protocols.	
	External - stackable modules inc. cartridge tape & 8" floppy & hard disks.	

CP/M, MP/M11, CP/M86, MP/M86 & CP/NET are trademarks of Digital Research Inc. Z80A is a trademark of Intel Corp. MS-DOS is a trademark of Microsoft Corp. Comart and the Comart logo are trademarks of Comart Ltd.

The following are just a few of the more complex applications where the Communicator can be found at work:

Communications: Networking · Telex capture · Typesetting · Intelligent work stations · DDP · Software production.

Medical: Endoscopy · Dispensing · Patient records · Prescriptions · Appointments · Pharmaceutical wholesaling · Clinical research.

Factories: Interactive management systems · Production and stores control · Shop floor data collection · Automated assembly

Robotics · QA · CAD & CAM · Oil rig data monitoring.

Construction: Structural analysis · Timber fabrication · Glass sizing and cutting · Architects.

Transport: Fleet management.

Education: Student admin. · Membership & subscriptions.

Government: Military systems · Administrative & catering · Project planning.

- I am an OEM/System Builder/Software House, please send me further details and a Communicator OEM pack.
- I am an end user interested in (application) please put me in touch with my nearest Communicator OEM.

Name _____
Position _____
Company _____
Address _____
Tel. _____

● Circle No. 106

PRACTICAL COMPUTING May 1984

Growing Acorns

ACORN HAS LAUNCHED a co-processor add-on unit for the BBC Micro, though not the long-promised Z-80 option. Instead, the new unit offers a second 6502, like the main processor, but running 50 percent faster at 3MHz.

Linked together by the Tube interface, the two chips allow all I/O functions to be handled by the main unit while programs are dealt with by the add-on. The result is a greatly enhanced performance; indeed, Acorn claims it is second only to that of the Sage II among home and personal computers.

The new unit also increases total RAM available. Using the Hi-Basic included with the add-on as a ROM chip a total of 44K is available for Basic programs. Up to 60K is free for assembly-language programs. The 6502 Second Processor costs £199, including VAT.

Acorn has also announced the Bitstik drafting joystick for use with the new co-processor system to allow freehand drawing. The system also offers routines for producing straight lines, circles, arcs, tangents to arcs and brush strokes, all called from an on-screen menu. Images saved on disc may be placed anywhere on the screen, scaled, squashed along one axis, placed at an angle or reversed.

Any part of the screen can be expanded to add details. Further enlargements can then be made up to a factor of 2^{120} . It is also possible to pan off the screen.

Lines can be drawn in three colours, and shapes and backgrounds painted with colours chosen from a palette containing four solid colours and 12 shades. Text can also be added and manipulated. In addition to the second processor unit a dual disc-drive unit is required; a special ROM chip is also supplied. The cost is £375 including VAT; both the Bitstik and the Second Processor are available from Vector Marketing Ltd and Acorn dealers.

It promises to be a fruitful year for Acorn. The Z-80

second processor will come bundled with standard business software packages and Cobol, and will probably cost less than the £400 previously suggested. Acorn will be also launching a Prestel adaptor in the next month.

Another second processor unit, containing the 16032, is also due. It will come with Unix and Fortran 77, designed for heavy number-crunching applications. Last but not least there is the Advanced Business Machine, or ABM. Although not intended as a competitor to the Sinclair QL — the price will evidently be quite different — Acorn is quietly confident that it will add a very strong second string to its bow.



The Acorn Bitstik system provides CAD on the BBC Micro.

Touch screen

AS HEWLETT-PACKARD begins the hard sell of its touch screen system, a stand-alone monitor incorporating this new technology has been announced by Terminal Display Systems Ltd. The TDS Touch Screen connects to micros via a standard RS-232 interface, operating at speeds ranging from 150 baud to 9,600 baud. Data output is in the form of three ASCII characters which indicate the hit co-ordinates. A resolution of 0.125in. is claimed with a scan rate of eight frames per second.

There are two modes of operation: Point and Stream. Point mode requires the finger to break beams and then be removed for at least a frame before another valid hit is registered. Stream mode

operates continuously, allowing smooth, continuous movements across the screen.

The TDS Touch Screen costs £2,550 excluding VAT, and is available from TDS Ltd, Philips Road, Whitebirk Estate, Blackburn, Lancashire BB1 5TH. Telephone: (0254) 676921.

BBC Pantos

TWO NEW drawing aids for the BBC have been launched.

RD Laboratories' Tracer is designed specifically with children in mind. It is simple to use and robustly built. Using the two pivoted tracing arms, lines can be copied and then routines used to draw straight lines between points, and colour-fill

areas. Other facilities include geometrical constructions and text entry.

The Tracer costs £69.95 including VAT and comes with software on a cassette. Details from RD Laboratories, 20 Court Road, Cwmbran, Gwent. Telephone: (06333) 74333.

A true pantograph device for the BBC Micro has been developed by the Reekie Technology Company for £49.95 including VAT. Complex shapes can be enlarged or reduced and shown in colour. Images may then be stored to disc or cassette. Further information may be obtained from Reekie Technology Company, Beaufort Road, Richmond Road, East Twickenham, Middlesex TW1 2PH. Telephone: 01-892 2877.

(More news on page 15)

Software shorts

● Jane, the mouse-driven multi-function software package for the Apple II, is now available in the U.K. Jane integrates word processing, spreadsheet and list management, and uses graphic icons, overlapping windows and a mouse to simplify things for the user. The price is £299, which includes software, interface card and mouse. A demo disc costs £10. Details from Albion Computer Co. Ltd, 79-83 Great Portland Street, London W1N 5RA. Telephone: 01-580 9611.

● Melbourne House has followed up its best-selling Hobbit game, based on the Tolkien book, with a book telling you how to play it. A *guide to playing the Hobbit* is written by David Elkan and costs £3.95 from bookshops. The Hobbit runs on Spectrum, Commodore 64, Oric and BBC machines.

● Among the Spectrum, BBC and Commodore 64 packages from software house Bell Tech is Bell Gen, a genealogical records program. Costing £12.95 on cassette or £13.99 on disc, including VAT, Bell Gen helps track your family history and descent. Contact Bell Tech Ltd, Stanmore Industrial Estate, Bridgenorth, Shropshire WV15 5HP. Telephone: (07462) 5420.

● TK!Solver, hitherto only available on the IBM PC, can now be obtained for the Apple II and Wang PC. TK!Solver is essentially an equation solver but with What If? functions like a spreadsheet package, and more numeracy and processing power. The Apple IIe version requires 128K of RAM. The price is £350, including VAT, for either version TK!Solver packs, with models set up for various specific application areas, are available for £135.55. Details from Marketing Micro Software Ltd, Goddard Road, Whitehouse Industrial Estate, Ipswich IP1 5NP. Telephone: (0473) 462721.

Puzzled ?



Over the past seven years, we've got used to solving other peoples' problems.

The chances are we have the answers to your computer queries, too. We'll suggest the system that will best fit into your business environment, help you put the pieces together, and show you how data processing completes the picture.

In other words, pre-sales advice, installation and training, plus full technical support, are all part of our comprehensive service.

Call us today, and we'll arrange a free demonstration.

NEC



EPSON

apricot

Telephone or write now
for a free product catalogue:

Interam Computer Store,
FREEPOST, London SW1 2 9AQ
Tel: 01-675 5325 Telex: 925859

INTEDAM

MICROCOMPUTER SPECIALISTS

UNIT 25, THAMES HOUSE, SOUTHBANK BUSINESS CENTRE,
140, BATTERSEA PARK ROAD, LONDON, SW11 4NB.
TEL: 01-622 9373. TELEX: 925859.

Exxon 750

EXXON OFFICE SYSTEMS, part of the giant oil company which sells Esso petrol in the U.K., has launched an office work station to compete with the IBM PC XT. It has two processors, a Z-80 for running CP/M and a Z-8001 true 16-bit chip for other applications running under Exxon's own multi-tasking operating system.

A second Z-8001 is used to control the bit-mapped display and offers up to seven windows on screen at the same time. The use of multiple Z-8000s may not be unconnected with the fact that Exxon owns Zilog. An 8088 expansion card to support MS-DOS is planned later.

The Exxon 750 comes with 512K of RAM, expandable to 1Mbyte, and 128K of ROM. Disc storage comprises a 10Mbyte hard disc and a 600K 5.25in. floppy.

Software includes Exxon's own word processor, the Supercomp-Twenty spreadsheet with 1,000 rows by 1,000 columns, and the Graphwriter business-graphics package. The software is supplied with the machine, and takes up 2Mbyte of the hard disc. The price is very competitive at £6,600.

It is unlikely that the Exxon 750 will be sold via normal microcomputer outlets. Exxon is in the office-automation market catering for major corporations. The 750 will link to a mini known as the 8400 Series Shared Resource System, which supports up to 16 Exxon 500 work stations.

Contact: Exxon Office Systems (U.K.) Ltd, Expro House, 21 Dartmouth Street, London SW1H 9BE on 01-834 6677.

Hard Apricots

ACT HAS ANNOUNCED hard-disc versions of the Apricot. The Apricot XI comes in two varieties: 5Mbyte costing £2,695 and 10Mbyte for £2,995.

Other upgrades in the pipeline for this year include a modem, already BT approved but waiting for electrical standards clearance, a double-sided microfloppy to take capacity up to 1.44Mbyte, and a LAN.

Details on the XI are available from dealers or direct from ACT. Telephone: 021-454 8585.



The PC-2000 from Tatung.

Tatung micro

TATUNG, the Taiwanese multinational, has entered the micro market with a Z-80 based machine costing £1,699. The PC-2000 has 64K RAM, two 5.25in. floppies each with 1Mbyte capacity and two ports, one RS-232 and one Centronics. The detachable keyboard has six function keys and a numeric pad.

Additional options include a graphics board and colour display instead of the standard 12in. green screen. Winchester are available with capacities ranging from 6.6Mbyte to 40Mbyte. Details from Tatung (U.K.) Ltd, Bridgnorth, Shropshire WV15 5BR. Telephone: (07462) 5721.

Companies old and new

ELAN COMPUTERS has re-emerged into the world with the rather grey if worthy name of Enterprise Computers after passing through the more memorable chrysalis phase of being called Flan Computers. A court injunction won by Elan Digital Systems forbade the use of the name Elan.

The long-promised 64K and 128K machines will also be called Enterprise. They are scheduled for launch in the U.K. in September and December respectively.

Meanwhile, an enterprising machine that did make it on to the streets, the Jupiter Ace, has been resurrected. Boldfield Limited Computing has not taken over Jupiter Cantab Limited, which went into liquidation last year, but has acquired the right to trade in its stocks.

It is now possible to obtain

one of the neat little micros running Forth for a mere £26. Extra 16K RAM packs cost £20 and software cassettes £3. For details telephone (0487) 840740.

Another Cambridge-based firm, Sinclair Research, has just signed an agreement licensing production of its micros in South Korea. The first ZX-81s and Spectrums should be available from Samsung Electronics later this year. Samsung produces a wide range of electronic products and had a turnover of \$500 million last year.

Lynx Laureate

AT LONG LAST Computers has launched the CP/M version of its Lynx computer. Called the Lynx Laureate, it features two separate floppy-disc drives, a parallel printer interface, CP/M, Perfect Writer/Speller, Calc and Filer programs from the Perfect Software suite.

The Laureate has 64K of RAM and 64K of video RAM. The total price is just 5p short of £1,000, or the machine can be bought on its own for £400. The 48K Lynx can be upgraded to a Laureate for £200, and the 96K model can be upgraded for £135.

A joystick interface is also now available and costs £15.

Contact Computers, 33a Bridge Street, Cambridge CB2 1UW. Telephone: (0223) 315063.



Egged on by the sight of the new Apricot XIs with Winchester, owners of the old version may like to add an external hard disc. They are now available from Micro Memory Systems Ltd, with capacities of 5Mbyte to 20Mbyte. Prices range from £1,244 to £1,495. For details contact Micro Memory Systems Ltd, Kennet House, 65 London Road, Reading, Berkshire RG13 1JN. Telephone: (0635) 40405.

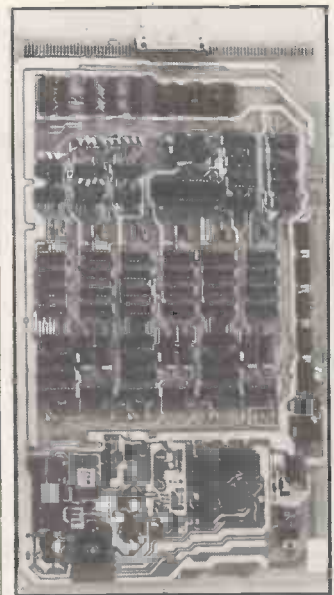

BTRL's frame store board.

TV store

A TV PICTURE frame store originally developed by BT Research Laboratories is being marketed by Eltime Ltd. The frame store allows a monochrome picture to be stored with a resolution of up to 512 by 512 pixels. If a lower resolution is selected, proportionately more frames can be held.

The store board interfaces directly to any of the Motorola 6800 series of eight-bit processors. Individual pixels can then be accessed via the data bus.

The unit costs £1,275 and is available from Eltime Ltd, Unite D29, Maldon Industrial Estate, Fullbridge, Maldon, Essex CM9 7LP.

UNBEATABLE apple VALUE

APPLE IIe

Apple IIe 64K	£499
D/Drive W/Controller	£250
D/Drive without	£200
80 Col. Card	£50
80 Col+ 64K	£150
Apple 12" Monitor	£125
Phoenix 12" Monitor	£90

Le Macintosh™



The Computer Sensation of 1984

Phone for latest price details

Lisa 2

CHEAPER & FASTER

Lisa 2 with Macintosh operating system £2625

Lisa 2/5 with 5Mb Hard Disk £3375

Lisa 2/10 with 10Mb Hard Disk £4135

Superb Graphics and Integrated Software

THE SUPPORT PACKAGE

- **Training** — Free half day appreciation course before you BUY
— Free one day application training when you buy your Apple from us.
- Full year guarantee on all parts and labour.
- On site maintenance available.

SIMMONS MAGEE PRICE PROMISE

We will guarantee to compete with any advertised price on Apple.

PRINTERS

EPSON	RX80	£242
	RX80 F/T	£269
	FX80	£350
OKI	82A	£299
	92	£439

For computerised solutions to business problems contact

SIMMONS MAGEE COMPUTERS LTD

13 YORK STREET, TWICKENHAM, MIDDLESEX TW1 3JZ

01-891-4477

ALL PRICES EXCLUSIVE OF V.A.T.

SERIOUS DECISIONS NEED THE SUPPORT OF OUR 80 COLUMNS



Most serious users of micro computers require the facility to display in 80 columns, especially for word processing. Try this on most monitors and the result will be a frustratingly fuzzy image.

The Microvitec CUB 653 gives the user not only glowing colour, but also pin-sharp-images, thanks to a medium resolution screen 653 pixels wide by 585 high, plus a selective transmission

panel giving super-high contrast. These features make this model from the CUB range of monitors the perfect partner for the high resolutions generated by BBC B, SINCLAIR Q.L., I.B.M.,

MICROVITEC
cub
COLOUR DISPLAYS

ELECTRON, ORIC, APPLE II and Ile, and many others.

So if you wish to sharpen your image, whether in the office or at home, decide Microvitec:

Remember – the highest quality doesn't have to mean the highest cost.

Call at your local dealer or contact us direct and we'll send you full details with a pleasant surprise – our price list.

Microvitec Ltd., Futures Way, Bolling Road, Bradford BD4 7TU. Tel: (0274) 390011. Telex: 517717.

Microvitec Monitors are available from your specialist local computer dealer, selected branches of W. H. Smith, John Lewis Partnership, Lasky's, John Menzies and other leading retailers.

● Circle No. 108

There are spreadsheets and spreadsheets And there's

Multiplan has always been rather special. Right from its very conception, it was designed to be more powerful and easier to use than all other electronic spreadsheets.

And it is.

Multiplan will give you fast access to the information needed to make decisions.

And allow you to explore the possibility of that information.

All presented in attractive easy to read formats, rather than the cryptic codes of

	1	2	3	4	5	6	7	8
	January	February	March	April	May	June		
SALES:	4700	6000	6500	7500	9000	9500		
COSTS:								
Materials	300	250	310	420	530	620		
Mages	1500	1500	1500	1500	1500	1500		
Heat/Light	140	135	120	100	105	95		
Rent	1750	1750	1750	1750	1750	1750		
Stationery	60	20	15	20	25	30		
TOTAL COSTS:	3750	3655	3695	3790	3910	3995		
GROSS PROFIT:	950	2345	2805	3710	5090	5505		

COMMAND: Blank Copy Delete Edit Format Goto Help Insert Lock Move
Name Options Print Quit Sort Transfer Value Window Xternal
Select option or type command letter
R19C3 RI-151C-R1-31C 99% Free Multiplan: one

Easy to read formats.

	1	2	3	4	5	6	7	8	9	10	11	12	13	14	15
	January	February	March	April							Six-months				
SALES:	4700.00	6000.00	6500.00	7500.00							43200.00				
COSTS:															
Travel	13.00	19.00	27.00	17.00							139.00				
Stationery	60.00	20.00	15.00	20.00							170.00				
Heat/Light	140.00	135.00	120.00	100.00							695.00				
Materials	300.00	250.00	310.00	420.00							2430.00				
Equipment	500.00	1200.00	300.00	900.00							4100.00				
Mages	1500.00	1500.00	1500.00	1500.00							9000.00				
Rent	1750.00	1750.00	1750.00	1750.00							10500.00				
GROSS PROFIT:	950.00	2345.00	2805.00	3710.00							5090.00				

COMMAND: Blank Copy Delete Edit Format Goto Help Insert Lock Move
Name Options Print Quit Sort Transfer Value Window Xternal
Select option or type command letter
R1C1 99% Free Multiplan: FOUR

Comparing information with windows.

our competitors.

When we say Multiplan is easy to use, we mean just that.

With a capacity of 63 columns by 255 rows, there's not much you can't feed in.

And, more importantly, it can actually link information in different worksheets.

Which means that adjustments on a primary worksheet can automatically be made on related sheets.

readsheets readsheets.

Multiplan.

Move up to Multiplan

Because Multiplan offers such powerful models and presentation capabilities, it's capable of all sorts of little extras.

You can sort entries alphabetically, or present the result of a formula in either numbers or as a message.

And users of 'other products' can move

up to Microsoft as Multiplan can read their models directly. So there's no excuse.

There are businessmen and businessmen.

And there's you.

MICROSOFT[®]
Right. First time.

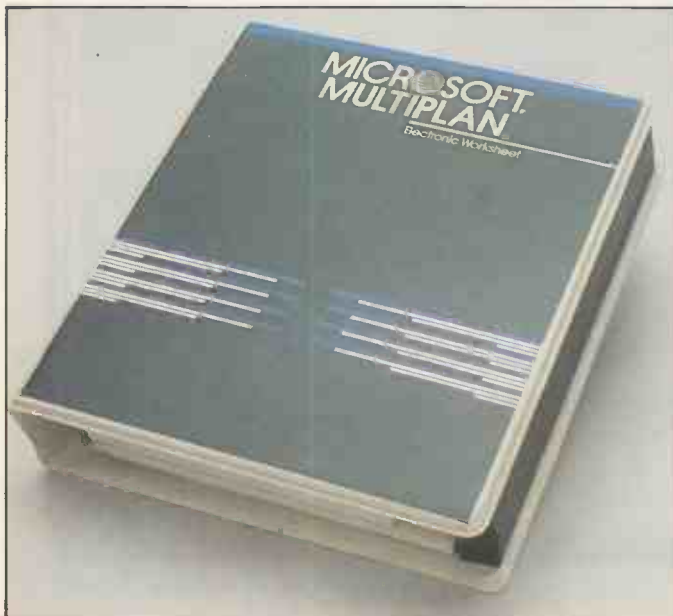

Multiplan is available on MS-DOS, Apple and CP/M 80 microcomputers.

If you require more information complete the details below or telephone us direct.

Please send me further information on Microsoft Multiplan.

Name _____

Position _____

Company _____

Address _____

Microsoft Ltd., Piper House, Hatch Lane, Windsor, Berks
SL4 3QT. Tel: (0753) 559951.

PRA05/4PI

If your microcomputer job involves managing information, you'll need a Compssoft Data Management System. It's your guarantee that computerisation will be a success.

Compssoft are world leaders when it comes to easy to use database programs. There is nothing quite so genuinely user friendly, and nothing quite as powerful. And Compssoft were the winners of the 1983 RITA (Recognition of Information Technology Achievement) Awards 'Software Product of the Year'.

We can give your *Computer the power to breeze through the management of any record keeping situation, - effortlessly, efficiently, and more accurately than you ever dreamed possible. From sales ledger to stock control, purchaser ledger to personnel, clubs to customers, and in a thousand other ways, we can lend a helping hand.

You don't have to be a computer expert to use Compssoft's DMS or Delta. Both programs offer fast, accurate and elegant database power for both first time computer users and professional systems designers.

You owe it to yourself to know more. Either return the coupon to us, or simply telephone the office and we'll send you a complete guide to our versatile database programs - today.

* Delta is available for almost any microcomputer with the MSDOS, PCDOS, CP/M, or MP/M operating systems, including IBM, DEC Rainbow, SIRIUS, XEROX, ICL, EPSON and many others.

DMS is also available for Commodore computers.



Compsoft Limited
Hallams Court
Shamley Green
Nr Guildford, Surrey
England GU4 8QZ

Telephone: Guildford (0483) 898545
Telex: 859210 CMPSFT



VISA

Please send me further details

Company _____

Contact _____

Address _____

PC _____

Tel No. _____

Concurrent CP/M runs IBM software

VERSION 3.1 of Concurrent CP/M can directly run application software developed for the IBM PC. For example, Lotus 1-2-3 developed for PC-DOS 1.1 will run under the new Concurrent CP/M.

Concurrent CP/M can support up to four windows with different programs running in each. In the illustration, a second window shows Concurrent CP/M as it appears when you first invoke the IBM PC emulation mode.

Unfortunately you can only mimic PC-DOS version 1.1, not the current PC-DOS 2 versions and above, which take up more space. But this new ability of Concurrent CP/M shows the way operating systems are evolving towards a virtual

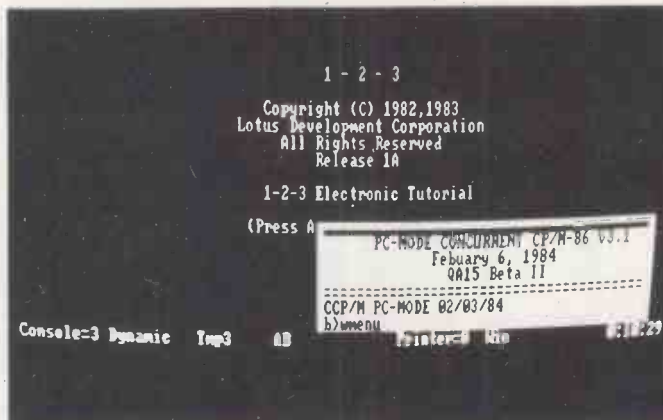

operating system which can emulate a variety of different operating systems, allowing the user access to several different software bases.

Concurrent CP/M costs about £235 one-off, or probably

less as hardware manufacturers are likely to bundle it in with their machines. More details from Digital Research, Oxford House, Oxford Street, Newbury, Berkshire RG13 1JB. Telephone: (0635) 35304.

Improved graphics for GWBasic

RELEASE 2.0 of Microsoft's GWBasic adds major graphics features to the language and enables the programmer to make full use of MS-DOS 2.0 operating-system commands.

New graphics functions include Window and View. The Window command lets you declare screen dimensions independently of your physical screen size, while View lets you define areas of the physical screen on to which the window contents are then mapped. The two statements make programs easier to adapt for different machines.

More details from Microsoft Ltd, Piper House, Hatch Lane, Windsor, Berkshire. Telephone: (07535) 59951.

Foreign languages

FRENCH, German, Italian and Spanish self-learning packages are now available for the BBC, Oric 1 and Oric Atmos, with versions for many other machines expected shortly.

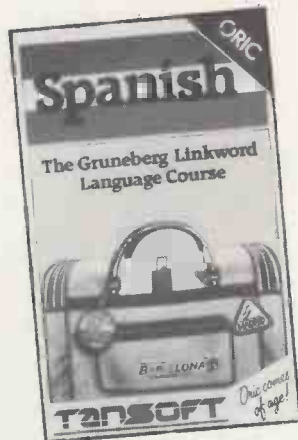

Aimed mainly at holidaymakers and occasional travellers, the programs all use a new language teaching technique which claims to make a basic 400-word vocabulary easier to learn.

The system is called Linkword, and is the invention of Michael Gruneberg, a psychologist at University College Swansea. The idea is to remember the meaning of a foreign word by associating it with a like-sounding English word. For example, to get you to remember that the German for lobster is Hummer the system will instruct you to imagine a lobster with a sense of humour.

Several software houses are working on getting Linkword

packages out in time for the peak holiday period, including Silversoft for the Spectrum, Dragon Data for the Dragon, English Software for Atari and Audiogenic for the Vic-20 and Commodore 64. Versions for the Sirius, Apricot and IBM PC are being developed by ACT.

Oric 1 and Atmos versions are already available, price £12.95 each including VAT, from Tansoft. Details from Tansoft Ltd, Units 1 and 2, Cambridge Technopark, Newmarket Road, Cambridge. Telephone: (02205) 2261. Acornsoft's BBC versions cost £14.95 each. Contact Acornsoft Ltd, 4a Market Hill, Cambridge CB2 3NJ.

Software catalogue

WH SMITH is publishing its own business software catalogue as part of its deepening commitment to computing. It will come out every two months and cost 75p.

The new catalogue will feature serious software such as the Peachtree accounting packages, rather than games. It

(continued on page 23)

Hardware shorts

● If you can convert from hexadecimal to decimal in your head, then you probably won't need the Casio FX-450, a base-converting scientific calculator. The cost is £22.05, and details are available from Casio on 01-450 9131.

● With the Ram Turbo interface for the Spectrum, it is possible to use ROM cartridge software, Microdrives and up to two joysticks. The cost is £22.95, and the unit is available from Ram Electronics. Telephone: (02514) 5858.

● Anyone who actually has an Electron might be interested to know that a printer interface and user port are available for £39.95 from Broadway Electronics. Other units in the pipeline include a disc interface, joystick controls and sideways ROM. Details on (0234) 58503.

● A BT-approved modem for £84 is produced by OE Ltd. Telemod 2 has an integral power supply, and can be hooked up to a wide range of popular micros including the BBC, Commodore, Apple and Atari. Contact OEL on (0768) 66748.

● IBM PC owners wishing to luxuriate in the full visual glory of their system can now buy a 20in. colour monitor from Microvitec Ltd. The cost is £695 excluding VAT. For details telephone (0274) 390011.

● Maxell is now producing 8in. floppies which hold a capacious 10Mbyte. They are distributed in this country by CPU Peripherals Ltd. Cost structuring has yet to be announced. For more details telephone (0621) 817269.

● Yamaha's CX-5 computer/synthesiser is available for £550. It comes complete with both typewriter and musical keyboards, and is part of the MSX invasion from Japan. A near realisation of the system was reviewed in last month's *Practical Computing*. More information on (0908) 640202.

If you are thinking of buying more than one PC - think again about

Jarogate's MP5 the CP/M multiprocessor

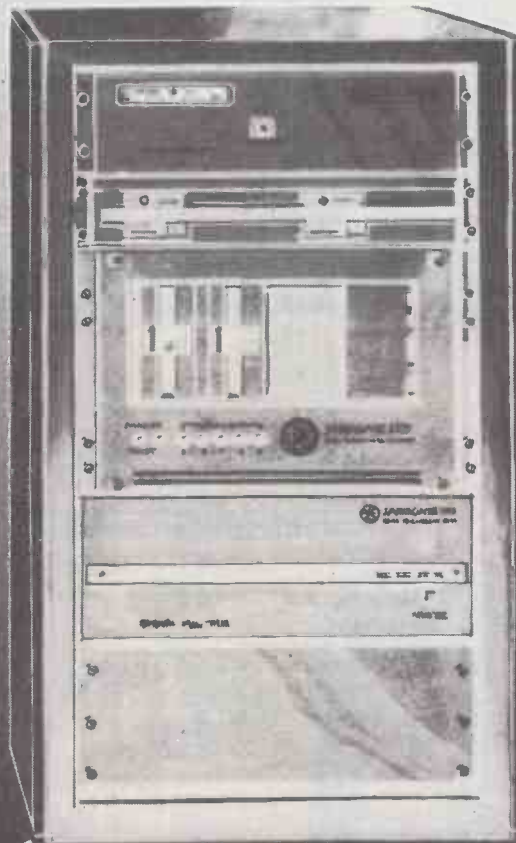

ICL/IBM
& OTHER
COMMUNICATIONS

CARTRIDGE & REEL
TO REEL TAPE

PRESTEL

ETHERNET FOR
MULTIPLE MP5
CONFIGURATIONS

FROM 5 TO 600MB
SHARED DISC
STORAGE

MULTIUSER TELEX

PERPETUAL
REAL TIME
CLOCK/CALENDAR

UP TO 16 USERS
EACH WITH 64K
Z80B(6MHZ) & S100 BUS

SHARED PRINTERS
AND PLOTTERS

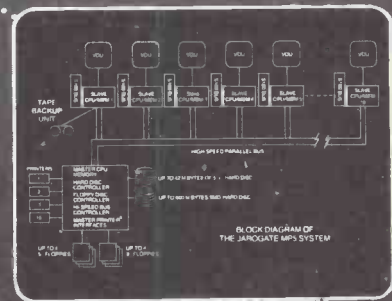

COLOUR GRAPHICS

8 AND 5 1/4 FLOPPY DISC

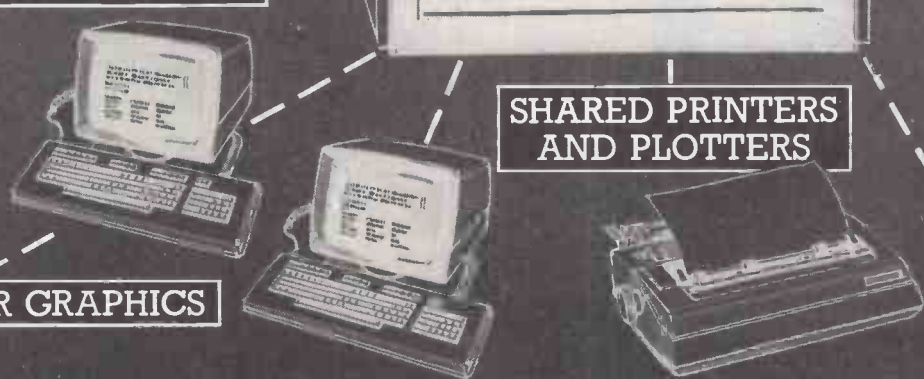

Z80H (8MHZ) & IAPX 286 (16 BIT) PROCESSOR OPTIONS.
WILL SUPPORT ANY CP/M OR MP/M APPLICATIONS SOFTWARE.

**YOU HAVE JUST THOUGHT
ABOUT A BRITISH MADE, LOWER COST,
HIGHER PERFORMANCE SOLUTION.**

FROM £1995.



JAROGATE LTD.
the microprocessor specialists

**NATIONWIDE
MAINTENANCE
SUPPORT**

197-213 Lyham Rd., Brixton, London SW2 5PY Tel: 01-671 6321 Telex 8950094 JARO G

(continued from page 21)

will also list dealers where the products can be obtained.

Behind the new venture is a tie-up between W H Smith and U.S. software distributor Softeam Inc. A new company, WHS Softeam Ltd, has been set up to distribute software to dealers in the U.K. Readers of the catalogue are pointed to a dealer in their areas which WHS Softeam is to supply.

Machines supported include the IBM PC, DEC Rainbow and Epson QX-10. The catalogue should appear in W H Smith shops in April.

Dealers can find out more from WHS Softeam, Euston Street, Freemans Common, Aylestone Road, Leicester LE2 7SS. Telephone: (0533) 547671.

Music scores

MUSIC MATE is the musical equivalent of a word processor. Aimed at composers, music teachers and enthusiasts, it lets you prepare a score in a convenient way: you type in the notes and duration and the package prints out the score.

The package can automatically transpose between



keys and can handle multi-part scores. Music Mate runs on most CP/M and MS-DOS systems and costs £150. An Epson dot-matrix printer is required to print out the music scores. More details from MPI Ltd.

Detective mysteries

IN Murder by the Dozen for disc-based Apple II systems you are a detective trying to solve a murder — or rather 12 murders. Each different murder case forms a separate game, and has

its own location, characters, clues and red herrings.

Written by CBS Software, Murder by the Dozen costs £23.95 plus VAT from Pete & Pam. Contact P & P Distributors Ltd, New Hall Hey Road, Rossendale, Lancashire BB4 6JG. Telephone: (0706) 212321.

Small-scale integration

EASI-ONE brings integrated software to the battery-powered Sharp PC-1500. Supplied on cassette, Easi-one allows six different functions to be held in memory. You can choose between them with a single keystroke from the graphic display menu.

Incorporated in the package are a spreadsheet, a text editor, a statistics utility, an alarm/calendar, a notepad and a unit-conversion utility.

Easi-one requires a Sharp 1500 system with cassette interface and the 8K or 16K RAM modules. It costs £24.95 including VAT and postage.

Contact Elkan Electronics Ltd, 11 Bury New Road, Prestwich, Manchester M25 8JZ. Telephone: 061-798 7613.

Software Exhibition

FROM June 5 to June 7 Earls Court will host the Software '84 exhibition, sponsored by *Practical Computing*, *Computer Weekly* and *Software* magazine among others. Devoted to business and professional software rather than leisure interests, 120 stands have already been booked. Hours are from 9.30am to 6pm.

A conference associated with the exhibition is being organised by the National Computing Centre. Details are available from the NCC Seminars Department on 061-228 6333.

The exhibition itself is free to people with a business interest in software if they register in advance; otherwise it costs £2.

Registration forms can be obtained from Software '84, Reed Exhibitions, Surrey House, 1 Throwley Way, Sutton, Surrey SM1 4QQ. Telephone: 01-643 8040.

Unix for BBC

UNIX system III — the real thing — is now available for the BBC Microcomputer. The catch is that the BBC machine has to be greatly expanded, relegating it virtually to a terminal attached to an all-new computer.

Nonetheless, the £2,900 price on top of the cost of a BBC Micro is cheap for a Unix system. For the money you get the Torch Unicorn pack containing a 68000 processor for running Unix, a Z-80B for running CP/M, 256K of RAM, a 20Mbyte hard disc, a 400K floppy drive — and Unix itself.

More details from Torch Computers Ltd, Abberley House, Great Shelford, Cambridge CB2 5LQ. Telephone: (0223) 841000.

Foreign letter writer

TICK-TACK is designed to enable people with a smattering of a foreign language to produce acceptable business letters. Produced by the software side of publisher Longman, it is neither a language-teaching package nor a word processor, but something new.

Tick-Tack is based on a set of carefully chosen key sentences and paragraphs. You are provided with chunks of text on disc in your chosen language, plus a reference book with the phrases in English. As you enter code numbers from the reference book, the letter is built up in the foreign language.

The package also includes

standard model letters and a word list of common commercial terms. French, German and Spanish versions are available.

Tick-Tack is intended to be used in conjunction with a word-processing program, which is not supplied. It will run on the IBM PC with Easywriter, the ACT Sirius with WordStar, £80 on the Apple II, IIe and III with Apple Writer. The price is £150.

More details from Longman Group Ltd, Longman House, Burnt Mill, Harlow, Essex CM20 2JE. Telephone: (0279) 26721.

Visi On price cut

VISICORP has slashed the price of the key module in its Visi On integrated software environment. The applications manager, which establishes Visi On's Lisa-like user interface, now costs £80 instead of £375. The change in pricing strategy makes Visi On better able to compete against Microsoft and Digital Research's new operating systems, which also have windows.

Visi On applications remain as before, at £295 for the Calc, £285 for the word processor, £195 for graphing and £285 for the database/query system. Visi On runs on the IBM PC XT and Wang PC and requires a hard disc.

Details from Rapid Terminals Rapid House, Denmark Street, High Wycombe, Buckinghamshire HP11 2ER. Telephone: (0494) 26271.

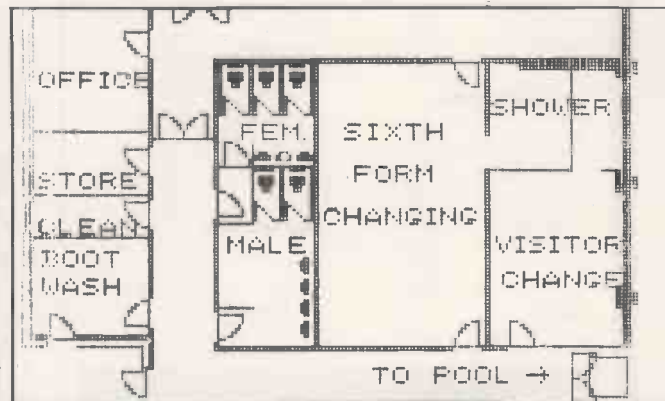

PXED is the graphics equivalent of a word processor for the RML 380Z. It lets you create and edit graphic images and put together sequences of graphic slides which can be used in presentations or incorporated into programs. PXED requires a 380Z with high-resolution graphics, 56K of RAM and 5.25in. disc drives. It costs £75 including postage. Contact The Headmaster, Douai School, Upper Woolhampton, Reading, Berkshire RG7 5TH.

LONDON COMPUTER CENTRE

NEC ADVANCED PERSONAL COMPUTER

16 bit 8086 128K RAM
2.4 Mb Disk storage
CP/M86-MSDOS
Green Screen
Colour Display



£1,985
£2,595



apricot

256K RAM 16 Bit
Nearly £1,000 Software included
from £1,495

SIRIUS 1

1.2 Mb Disk storage £2,195
2.4 Mb Disk storage £2,895
10 Mb Disk storage £3,995



NEW!

**SANYO
555
£1124**

16 bit 128K Expandable to 256K.
MSDOS. 2 Drives SANYO HIGH RES
Green Monitor.

With colour monitor (as illustrated) add £374
£1,600 software included,
Wordstar, Mailmerge, Spellstar,
Datastar, Reportstar, Calcstar,
Sage Accounting Package, Sales,
Purchase & Nominal Ledgers.

LCC SPECIAL BUNDLE

NEC APC	RRP	£1,985
Dot Matrix Printer	RRP	£295
Cables	RRP	£30
		£2,310
You pay		£1,985
You save		£325

COMPUTERS

EPSON QX10	£1,735
TANDY 4 from	£1,299
TELEVIDEO 806/816	PHONE
SUPERBRAIN	PHONE

PORTABLES

ZORBA with free 12" Monitor. Software worth £800 included **£1,395**

CORONA PC
IBM PC Compatible
256K RAM
Twin Drives **£2,295**

LAP PORTABLES

NEC 8201 16K	£475
EPSON HX20 16K from	£402
TANDY 100 8K	£433

DOT MATRIX PRINTERS

STAR DELTA 10 160cps	£399
STAR DELTA 15 160cps	£539
GEMINI 10X 120cps	£249
GEMINI 15X 120cps	£359
EPSON FX80 160cps/FX100 160cps/ RX 80 160cps/RX 80FT 100cps	PHONE
CANON 80 Col/156 Col	£319/399
RADIOSHACK (TOSHIBA) 2100	£1,130

DAISYWHEEL PRINTERS

FLOWWRITER 1600	£1,600
TEC F10 40cps	£1,350
TEC F1500	£450
JUKI 18cps	£399

SHEET FEEDERS

BDT 2 Tray Auto	£595
BDT 3 Tray Auto	£695
BDT Single	£375
Juki Sheet Feeder	£239
Juki Tractor Feeder	£99
Tractors (Qume RICOH, Tec)	£139

HARD DISKS

Hard Disks for IBM PC Sirius QX10, NEC

10 Mb	£1,545
15 Mb	£1,695
20 Mb	£1,995
20 Mb Tape Streamer.	£1,495

PLOTTERS

Hewlett-Packard 7475A	
6 Pen Colour	£1,401
ROLAND DXy 800/101	
8 Pen Colour A3	£520

MODEMS/MONITORS

Buzz Box. Direct Connect Modem	£65
Sendata Acoustic Coupler	£220
Philips 12" Green. Hi Res	£85
Sanyo HIGH RES GREEN	£125
Sanyo HIGH RES COLOUR	£499

ACCESSORIES

Floppy Disks	Printer Buffers
Daisywheels	Paper
Ribbons	Labels
Cables	Computer cleaning kits
Disk containers	

SOFTWARE 8/16 Bit

The comprehensive range includes

WORDSTAR £235	D BASE II £349
SUPERCALC II/III £190-£275	SPELLING CHECKER £80
WORD PROCESSING £	LANGUAGES £
Spellbinder 290	MBasic 215
Peach Pack* 332	MBasic Compiler 235
Mutimate 332	C Compiler 330
Spellstar 134	Fortran 80/86 325
Mailist 50	Cis Cobol/Forms2 399/105
Grammatik 85	Pascal MT 240
FINANCIAL PLANNING	Pascal MT + "SSP 350
Plannercalc 85	ACCOUNTING
Multiplan 170	Pegasus from 250
Lotus 1-2-3 357	Peachtree from 325
D BASE CORNER	Sage 375
FastBase 150	Exact 500
Autocode 195	Pulsar from 195
Quickcode 205	COMMUNICATIONS
Dgraph 190	Bstam 130
Friday 185	Crosstalk 135
Infostar 266	Moveit 80/86 90
DMS 400	
UTILITIES	*Incl. PeachSpell/Mailist
Sid £60, ZSid £76.	Please telephone for the LCC
Mac £133	Software Catalogue

FORMATS: Superbrain, Televideo, Sirius, Sanyo, Osborne
Northstar, 8" SD, DEC, Epson QX-10, IBM
ICL, H-P, XEROX, ALTOS, Apricot, NEC-APC & many more
All prices are exclusive of VAT

Looking for an easy-to-use cost effective
File Handling System?

Thank god it's
Friday! £185
by ASHTON-TATE

Friday will take care of your Files, Reports, Diary,
Mailing and much more. It enables electronic files to
be set up. Reports can be displayed and retrieved fast
from all or part of a file. Friday is fast and versatile. It is
designed for beginners.

Friday enables you to prepare custom reports
to suit your requirements and presentation.
Friday enables you to sort and select any field.

Friday uses on screen prompts and help
menus to guide you through the job
you are doing.

**DEMONSTRATIONS
SALES-SERVICE
SUPPORT**

43 Grafton Way, London W1P 5LA (Opposite Maples)
Opening Hours: 10-7 Mon-Fri. 12-4 Sat.
01-387 4455 (4 lines) Telephone Answering Service After Office Hours
Telex: 8953742

MINSTREL Turbo

real multi-user networking that offers so much more



Networking

Each user has their own 8-or 16-bit computer, networked together inside the Minstrel, to run CP/M-80 or CP/M-86 compatible software.

Compatibility

Record-locking compatibility with MP/M means standard multi-user languages and packages are suitable for Minstrel TurboDOS systems.

Expandability

Using the ARCNET local area network up to 256 Minstrels of up to 6 terminals each may be linked together. Each Minstrel system may have up to 160Mb of Winchester storage.

Sophistication

The Minstrel Turbo is a true networking system with resource-sharing. Up to 9 spooled printers per Minstrel are accessible from any processor.

Versatility

A Winchester drive and 5" floppy disk drive are standard, 8" floppy drives are optional, as are tape cartridge drives, and IBM and ICL mainframe communications.

Telex

The Minstrelex package adds telex facilities to the Minstrel Turbo and features automatic send and receive, call logging, conversation modes.

Prices/Details

2-user system with:
20Mb Winchester
800Kb floppy
3 Z80A processors
connection cables
KDS7362 VDUs
TurboDOS
Operating System **£5625**
+ VAT

5-user system with:
40Mb Winchester
tape cartridge back-up
800Kb floppy
6 Z80A processors
connection cables
KDS7362 VDUs
TurboDOS
Operating System **£11160**
+ VAT

HMSystems
HMSystems Limited

69 Loudoun Road, London NW8 0DB
Telephone: 01-328 8737/8
Telex: 266828

odrut

stolt gashowitshararu -
shom burrice a

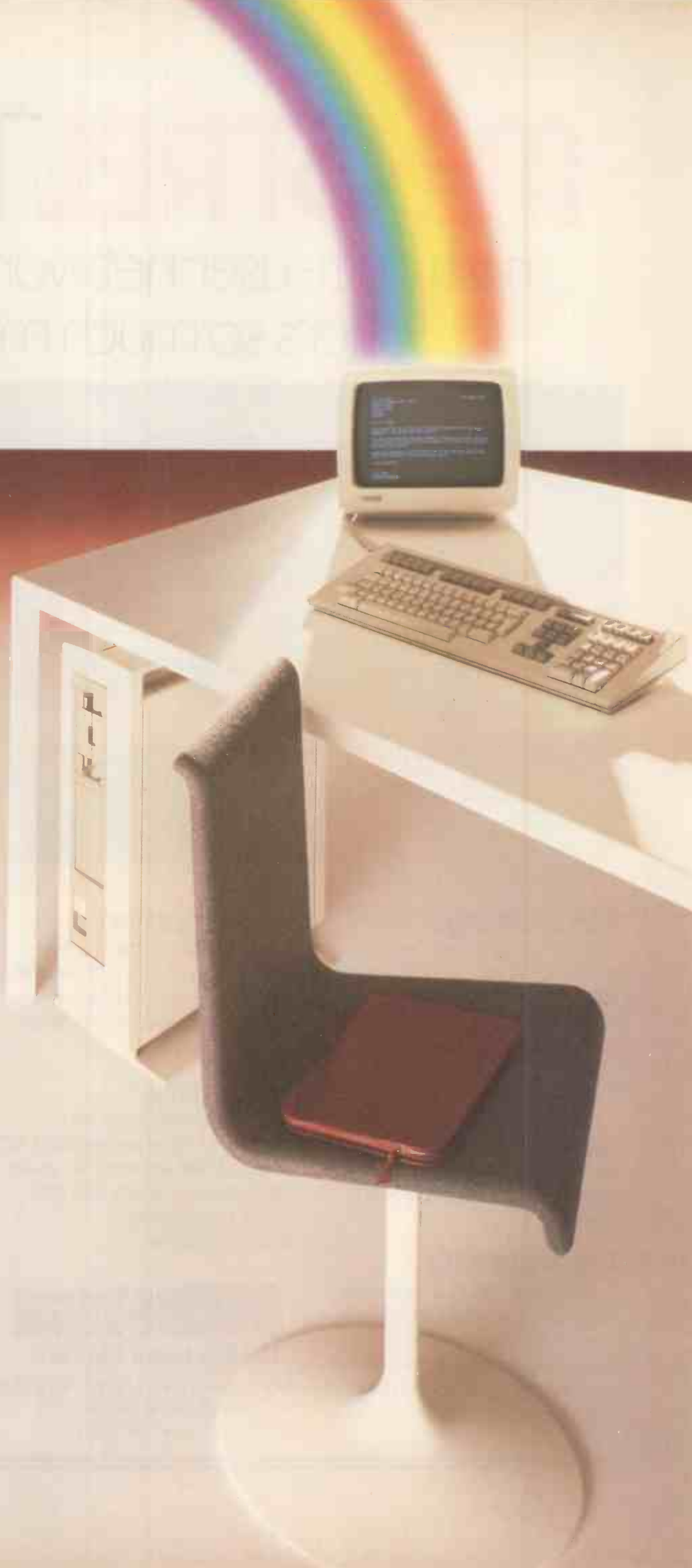

Any personal computer can help to solve business information problems, like word processing.

But imagine a personal computer that gives you a choice of three monochrome screens with an anti-glare coating that's easy on your eyes.

With up to 132 columns on a single screen for wider documents, a low profile keyboard (with adjustable key-click) ergonomically designed for comfortable typing and the choice of leading word processing programs, including Silicon Office.

With computer based instruction and free training courses to get you started quickly.

With on-site maintenance, 12 months warranty and telephone help for any problem at all, not to mention the lowest running costs in the industry.

With the flexibility to expand the system so it can grow with you. With the ability to work with larger computers (ours and other major makes) and access databases and company networks.

Only the Rainbow from Digital offers so many solutions. Clip the coupon and set your imagination free.

I would like to know more about the Rainbow.
Write to: Digital Equipment Co. Ltd., Customer Information Centre, Jay's Close,
Basingstoke, Hants. RG21 4DE. Tel: (0256) 59299. ● Circle No. 114

Name _____ Position _____

Company _____

Address _____

digital

The world's largest manufacturer of minicomputers.

A SOLUTION AT THE END OF EVERY RAINBOW



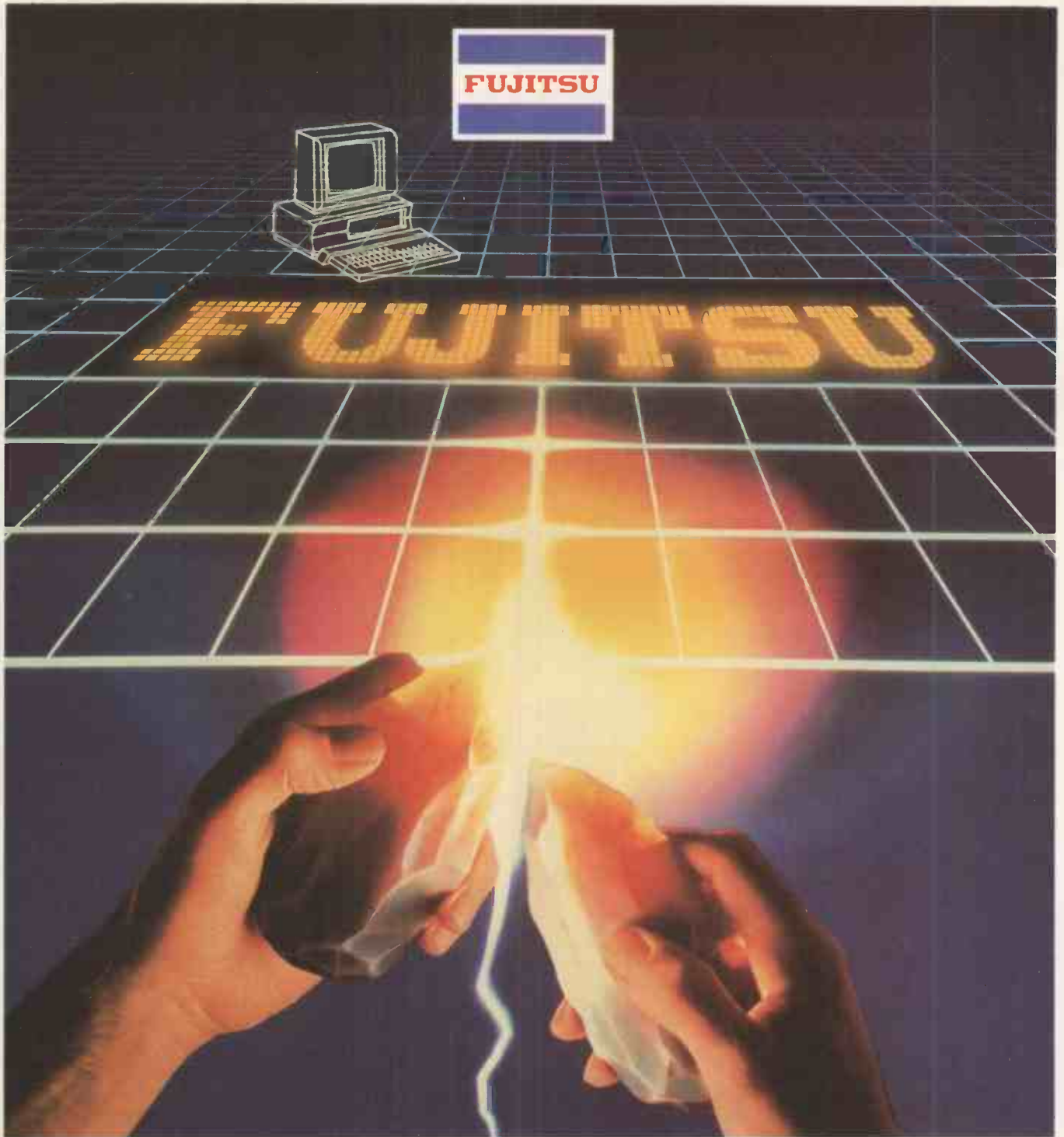

Personal Computers from Fujitsu. Japan's Leading Computer Manufacturer.

The name is Fujitsu. If you've never heard of it, don't worry. Not many people here have. But they will.

Fujitsu have been designing and manufacturing computers in Japan since 1935. Today, innovation, design, quality and reliability in every aspect of computer systems has earned Fujitsu a reputation as Japan's leading computer manufacturer.

Now Fujitsu are coming to Britain. Bringing a range of personal computers - the Fujitsu Micro 7 and Fujitsu Micro 16s. Both are unequalled, in quality or in price, because Fujitsu make all their components themselves.

Both offer user facilities that start with stand alone, low cost systems, building into powerful multi-user combinations. And both run industry-standard operating systems and application packages, so there is a wealth of software available.

Fujitsu. It's a name to remember.

And it's a name that's going to be around for a long time. You can rely on it.

For full information pack, please contact:

Fujitsu Micro Computer Systems, Fujitsu Mikroelektronik, 1 Curfew Yard, Thames Street, Windsor, Berks, SL4 1SN. Tel: 07535 50551



FUJITSU MICRO COMPUTER SYSTEMS

● Circle No. 115



DEC hits back

NOTHING, we are told, succeeds like success — and nowhere more so than in the field of computing. Plumping for a Ford Cortina processor may not provide the ultimate in available computing power but it will provide the best possible level of hardware and software support. And after all, it is these factors which are all-important to the average user; they can guarantee success for famous manufacturers of sometimes rather mediocre computer systems.

The IBM PC is an obvious example, where the prestige of its highly successful parent has ensured that support, software and add-ons are available almost to excess. Meanwhile some other machines with a superior technical specification but without a famous name slide silently beneath the surface of market indifference.

Vax supremacy

There are plenty of other examples of course, and it takes either a very brave or, more likely, a somewhat unsophisticated potential customer to choose a new system on the basis of performance rather than on the marketing muscle and track record of its manufacturer. Take the ubiquitous Vax midi-computer from Digital Equipment Corporation for example. Launched as an inexpensive 32-bit virtual-memory machine in 1978, and following hard on the heels of DEC's phenomenal success with the PDP-11 16-bit mini family, the Vax and its VMS operating system went on to become an industry standard in the 32-bit market.

Virtually every major company in the scientific and engineering community now owns at least one Vax system. To exploit its success to the full, DEC went on to introduce several compatible offspring to follow the initial Vax 11-780. The range now includes cut-down versions such as the 11-750 and 11-730, and souped-up systems such as the 11-782.

The success of the Vax has constrained DEC to maintain architectural and software compatibility across the family. Now there are lots of competing designs produced by other manufacturers, which boast very significantly improved performance and, often, lower prices. The newcomers have had relatively little success for all of the usual reasons.

One line of attack which has worried DEC is the outflanking manoeuvre currently being executed by the micro-processor designers. It is now possible to put a 32-bit processor with virtual-memory support on to a single chip of silicon. There are as yet few, if any, systems available based on these chips. But it will not be long before they appear, and the spectre of impending Vax-like systems costing only a

fraction of the Vax price has certainly had its effect in the DEC boardroom.

DEC's solution is simple. Rather than let the 32-bit market be captured by future systems based on Intel, Motorola or National microprocessors, DEC has had to head off the competition with a Vax-on-a-chip. The first step has already been taken by squeezing a complete Vax CPU on to two quad-width circuit boards which can be plugged into an LSI-11 style QBUS chassis. This has made it possible to build the first Micro Vax system. While it does not actually include a complete CPU on a chip, it looks as though it does by virtue of being packaged in a small under-the-desk cabinet complete with floppies and a Winchester.

The launch of the Micro Vax will no doubt be sufficient to stem the initial assault from the microprocessor brigade. But when prices drop still further, a CPU solution based on two quite complex circuit boards using non-VLSI technology will soon begin to feel the pinch on cost grounds. By then, however, DEC will be ready with its Vax-on-a-chip, and the two quad boards will be replaced by a single dual-width card costing considerably less.

Already DEC has announced that experimental versions of the Micro Vax are running, although four chips and a hybrid are required to house the beast, at least for the moment. But that is pretty good going for an implementation which contains a 32-bit processor with cache memory executing nearly all the Vax 11-780 instructions, a floating-point co-processor and a 4Gbyte demand-paged virtual-memory management system. Even micro-processors such as the National Semiconductor 32032 would need at least four packages to do a similar job.

Five packages

The five packages used in the current experimental design contain between them about 1.25 million individual active devices. The CPU itself contains around 140,000, and is able to execute all 304 Vax instructions, handle 17 data types and provide the control logic to manage a 4Gbyte virtual address space.

Inside the 68-pin processor package there are 16 general registers, 20 scratch-pad registers, a 32-bit arithmetic and logic unit and a 32-bit barrel shifter, all communicating via a 32-bit multiplexed address/data bus. In one 200 nanosecond microcycle the processor can read two registers, perform an ALU operation and store the result back into a register. The I/O cycle time is 400ns., allowing the processor to interface to the fastest dynamic RAM devices without wait states.

To facilitate the interfacing of the Micro Vax CPU to the rest of a system, the set also includes a 32-bit bus interface controller which generates all clock requirements from a 20MHz frequency source and controls the 32-bit synchronous back-plane bus. The chip provides extensive error detection and diagnostics, and is so complex and I/O intensive that it is housed in a special 132-pin ceramic package.

The processor is microcoded so that for each user-supported instruction there is a microprogram sequence which directly controls the processor logic, which is quite normal in processors of 16 bits or more. The Micro Vax chip set is unusual in that the microcode is held externally in a separate microprogram control store. It can be changed, if necessary, to provide new instruction-set facilities.

Built-in memory

The package which contains the microprogram control store is actually a ceramic hybrid substrate. It houses five separate chips which provide between them 16Kwords of ROM, 1Kword of RAM and 128 bytes of content-addressable memory. Also in the set is a floating-point accelerator co-processor which uses an 81-bit internal parallel data path and a 100ns. microcycle time to implement the 61 Vax floating-point arithmetic instructions directly in microprogrammed hardware. Finally, a memory/peripheral sub-system chip is provided to facilitate virtual-memory address translation operations.

When a single dual-width Vax processor card based on this chip set is available, the 32-bit microprocessors now appearing from the more traditional semiconductor manufacturers will be given a run for their money. Unlike the Micro Vax, most of them do not enjoy a worldwide software base and a huge number of already satisfied customers.

There is no word yet on whether DEC will be selling the Micro Vax chip set to original equipment manufacturers, but it is certainly a possibility. DEC has already entered the chip market by selling two separate LSI implementations of the PDP-11 16-bit CPU. These chips, known as the T-11 and the J-11, are doing quite well with system designers who appreciate the advantages of ready access to famous-name software. The name of the game is vertical diversification. Equipment manufacturers like DEC and semiconductor manufacturers like Intel are playing it to increase their share of the huge data-processing market. While Intel is moving up from chips to systems, DEC is moving down from systems to chips. □

Isn't it time you stopped running your computer at printer speed?

In ten seconds, your computer can output enough print data to keep your printer busy for five minutes, or longer.

Instead of waiting around for the printer, you could install a print buffer, and free your computer for its next task in seconds.

Print buffers take care of the printing — and the waiting. And the more you print, the more time a buffer will save.

Buffers for any combination of micro and printer/plotter. Internal buffers for Epson printers; Apple Computers. 'In-line' buffers for IBM PC, Sirius, Commodore 20/40/80 series, Super Brain, BBC, Tandy, etc.

Data transfer in RS232c serial, Centronics-parallel, IEEE-488 formats. Protocol conversion. RAM sizes from 2K to 256K.

A-Line Computer Systems

1 Church Farm Lane,
Willoughby Waterleys,
Leicestershire LE8 3UD.

Telephone:
Peatling Magna (053 758) 486

**Talk to the specialists.
We have the answers.**

● Circle No. 116

Superbase 64

TRANSFORMS THE COMMODORE 64 INTO A FULL-FEATURED AND PROFESSIONAL DATABASE SYSTEM! WITH UP TO 1000 CHARACTERS PER RECORD ON UP TO 4 SCREENS... AND UP TO 128 ITEMS PER RECORD, DEFINABLE AS KEY, TEXT, NUMERIC, CONSTANT, RESULT OR DATE... IN FILES OF UP TO 16M CHARACTERS! SUPERBASE 64 EVEN HAS SPREADSHEET AND CALCULATOR CAPABILITY, CALENDAR FUNCTIONS, EASY INPUT FROM WORDPROCESSOR/DATA FILES, BOTH MENU-DRIVEN AND PROGRAM OPTIONS, SORTING/SEARCHING, FULLY DEFINABLE OUTPUTS... SUPERBASE 64 IS ESSENTIAL IF YOU WANT THE MOST FROM YOUR 64! SUPPLIED ON CBM 1541 DISK WITH EXCELLENT TUTORIAL/REFERENCE MANUAL. **OUR PRICE £99.95 £88.00!**

VIZAWRITE 64

VIZAWRITE 64 IS A HIGH-PERFORMANCE, LOW-COST WORD PROCESSOR, WITH ON-SCREEN FORMATTING, THAT TAKES FULL ADVANTAGE OF THE 64'S COLOUR, GRAPHICS AND MEMORY FEATURES... AND SUPPORTS VIRTUALLY ANY PRINTER! WITH A COMPREHENSIVE AND EASY-TO-FOLLOW USER MANUAL, VIZAWRITE IS THE ULTIMATE PERSONAL COMPUTER WORD PROCESSOR! AVAILABLE ON CARTRIDGE (£69.95 £75!), DISK (£79.95 £68!) OR WITH VIZASPELL (£99.95 £85!)

Master 64

MASTER 64 IS A TOTALLY NEW CONCEPT... A COMPLETE PROGRAM DEVELOPMENT PACKAGE, THAT'S AVAILABLE NOW FOR THE CBM 64. MASTER HAS 85 NEW COMMANDS... AND BASIC IV TOO! PLUS PROGRAMMER'S TOOLKIT, MACHINE CODE MONITOR, BUSINESS BASIC, KEYED DISK ACCESS, MULTIPLE SCREENS, USER-DEFINABLE INPUT ZONES, REPORT GENERATOR, 22-PLACE ARITHMETIC, DISK DATA COMPRESSION, DATE CONTROL, SCREEN PLOT, SCREEN DUMP, AND MORE... EVERYTHING YOU NEED TO PROGRAM YOUR 64 TO TOP PROFESSIONAL STANDARDS! (£149.95 £115!)

MORE SOFTWARE FOR COMMODORE 64:

PRACTICAL (DISK/TAPE) ...	£44.95	£41.95
VIZASPELL (DISK)	£64.95	£49.95
DIL COMPILER (DISK)	£44.95	£189.00
DIL COMPILER (TAPE)	£36.95	
TOOL 64 (CARTRIDGE)	£48.95	£46.95

SOFTWARE FOR COMMODORE PET/700:

SUPERBASE (700/8096)	£64.95	£425.00
SUPERSCRIP (700)	£64.95	£425.00
SUPERSCRIP (8096)	£64.95	£375.00
SUPERSCRIP (3000-8000)	£249.95	£235.00
MASTER (4000/8000/8096)	£149.95	£225.00

PRICES SHOWN ABOVE INCLUDE 15% VAT, AND ARE CORRECT AT TIME OF GOING TO PRESS. PLEASE ORDER BY POST OR TELEPHONE, USING CHEQUE, ACCESS, BARCLAY CARD OR OFFICIAL ORDER. DESPATCH IS BY SAME-DAY 1ST CLASS POST, AND FREE (EXCEPT FOR OVERSEAS AND CREDIT ORDERS). FULL PRODUCT INFORMATION IS AVAILABLE ON REQUEST. (REF A27)

Calco Software

LAKESIDE HOUSE, KINGSTON HILL, SURREY, KT2 7QT. TEL 01-546-7256

● Circle No. 117

KINGSLEY ENTERPRISES

Specialists in all kinds of floppy diskettes

Mail Order Discs

Prices are for boxes of 10 discs

Soft Sector	Nashua	Xidex	Dysan	CenTech
5.25" Diskettes				
SS/SD.48	15.00	-	21.00	-
SS/DD.48	16.00	18.00	22.00	21.00
DS/DD.48	18.00	23.00	30.00	25.00
SS/DD.96	22.00	25.00	30.00	28.00
DS/DD.96	23.00	30.00	38.00	34.00
8" Diskettes				
SS/SD.48	20.00	-	25.00	-
SS/DD.48	21.00	22.00	29.00	29.00
DS/DD.48	22.00	26.00	33.00	33.00

Sony 3.5" (Apricot) Diskettes £36.00

Add carriage (£1 per box) and V.A.T. (15%)
Prices correct at time of going to press
Please ask for details of: hard sector discs,
business/educational accounts,
discounts, formatting.

KINGSLEY ENTERPRISES
87 Whitefield Road
Stockton Heath
Warrington
WA4 6NB

**Organise your files on
CenTech Colour
discs**

Tel:
0925 64207
for 24 hour
Dial-a-disc service

● Circle No. 118

MICROCOMPUTER

PRICE BREAKTHROUGH!

TWIN-DRIVE COMPUTER SYSTEM

FROM ONLY

£799



The MX Series are beautifully housed in a low profile brown/beige metal case.

Now MICRONIX smashes the price barrier of Professional Systems — 100% British designed and built. No frills, no gimmicks, no forced purchase of unwanted software at hidden cost! Our low, low system cost gives you freedom to choose and buy software to suit your requirement and still save money! Four models to choose from and a massive 21 Mbyte Hard disk Subsystem is also available. Based on the versatile MICRONIX 80HD Single Board Micro all models have • Z80A MHz CPU • 64k (expandable to 128k) RAM • 24 x 80 VDU • Floppy Disk Controller • SASI Hard Disk Interface • Real Time Clock/Calendar with battery back-up • Two RS232c Ports • Two Parallel I/O • Buffered BUS • ASCII Parallel Keyboard Port • Composite Video • CP/M compatible Operating System. Just add a terminal or video monitor and a keyboard (optionally available) and you are in business!

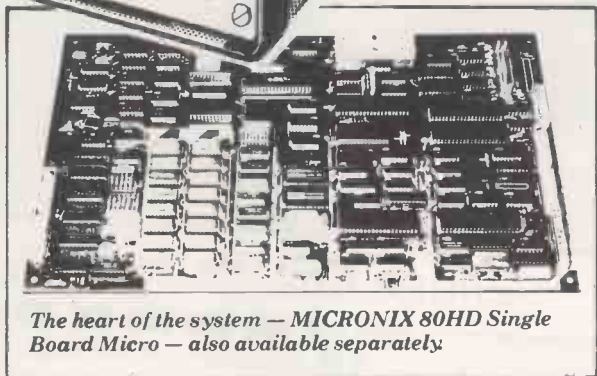

The heart of the system — MICRONIX 80HD Single Board Micro — also available separately

LOOK AT THESE PRICES!

MODEL MX400:
400K TWIN 5 1/4" SYSTEMonly **£799**
MODEL MX800:
800K TWIN 5 1/4" SYSTEMonly **£899**

MODEL MX1600:
1600K TWIN 5 1/4" SYSTEMonly **£999**
MODEL MX2400:
2400K TWIN 5 1/4" SYSTEMonly **£1,199**



micronix

computers Ltd

KEYBOARD: 102 Key Low Profile ASCII Keyboard only £125 (£5 carriage)
HARD DISK: Mass Storage Hard Disk Sub-systems complete with Software and ready to plug into any MX System above:
Model MX115HD 11.5 Mbyte Hard Disk only £1,250
Model MX216HD 21.6 Mbyte Hard Disk only £1,399
All prices are exclusive of carriage (£15 per System) and VAT.

Suite 2, 26 Charing Cross Road, London WC2. Tel. 01-240 0213/0217. Telex 295173 VILORD G

● Circle No. 119

If you're selling
mass storage devices,
you should be seen in

micro business

Micro Business is the magazine read by
retailers and dealers for trade information
on microcomputer products.

Each issue carries news of the latest
hardware and software available for retail
sale, with information on the terms of trade,
technical support and promotion - plus a
whole range of reports and comments
designed to keep the retailer and dealer up to

date with what suppliers are offering and
what the market is buying.

The July issue will focus especially on mass
storage devices. If you're selling these products
you need to tell Britain's micro dealers and
retailers about it.

You can, by advertising in Micro Business.

Phone Ken Walford on **01-661 3139** or clip the coupon

In am interested in advertising in your July issue. Please let me have details.

Name _____

Job Title _____

Company _____

Address _____

Tel _____

Telex _____

PCO Jly

Mail this coupon to Ken Walford, Advertising Manager, Micro Business,
Quadrant House, The Quadrant, Sutton, Surrey SM2 5AS, UK

KAYPRO. OUR WINCHESTERS HAVE BEEN WINNING THE WEST.

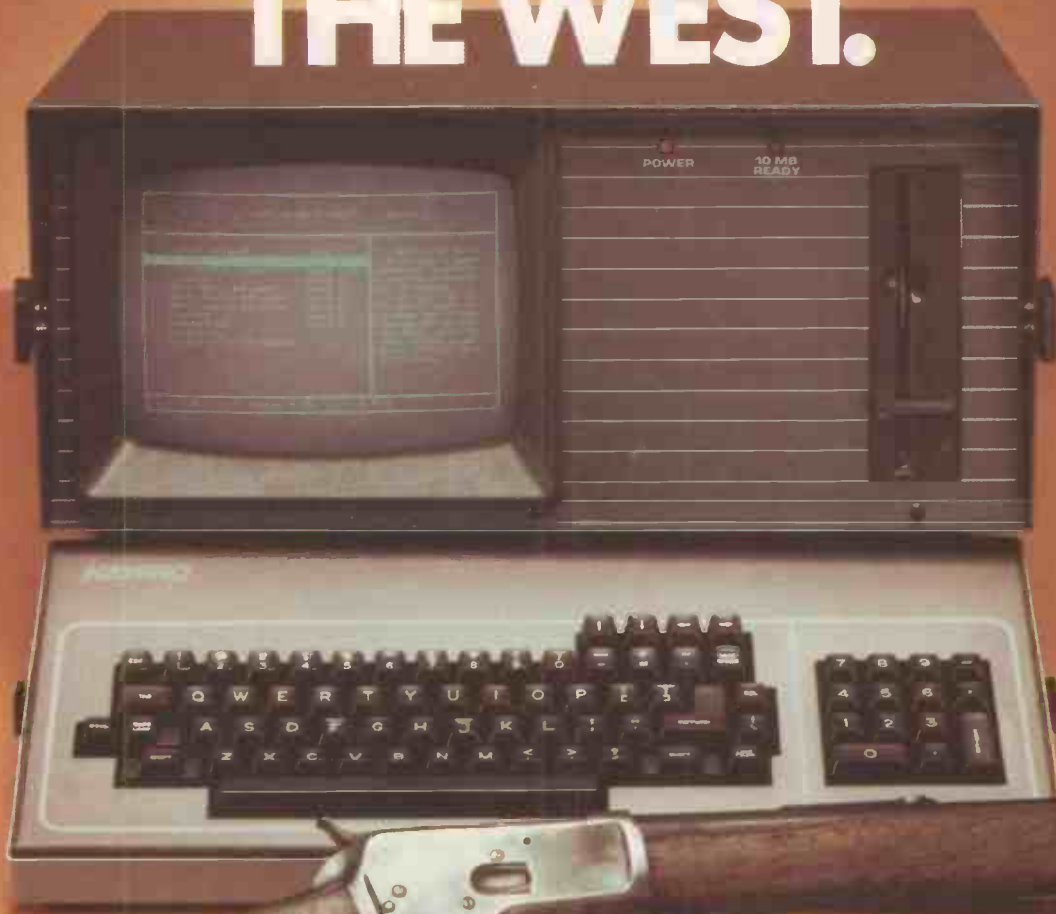

**KAYPRO 10
£2295**

Winchester Disks. That's the short answer why the Kaypro 10 professional computer is carving out big market territory for itself in the U.S. ten Megabytes of integral hard disk storage give it the edge over other systems in its price bracket.

And because the Kaypro is truly portable you can take it out into the field with you to tackle the big challenges head on: production

scheduling, sales performance analysis, technical processing ... or wherever real memory storage is vital.

More bang for your buck isn't the only reason why the Kaypro 10 and the floppy disk



A 9" screen that's easy on the eye.

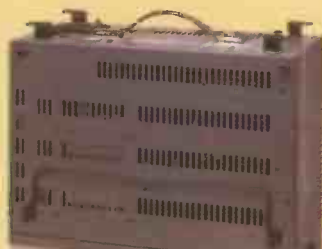

Kaypro 2 and 4 make sense for every business that's going places. There's a 9 inch screen, a stylish alphanumeric keyboard and access to a whole world of standard software (with a FREE get-you-started set of software applications including word processing and financial spread sheet).

Find out more about the portable system you won't outgrow from your Kaypro dealer. Or cut out the coupon for more details. The Kaypro range starts at £1,395.

To CK Computers, sole UK distributors of Kaypro. ● Circle No. 120
Please send me more details of the Kaypro range.

Name _____

Company _____

Address _____

_____ Tel. no: _____

6 Devonia House, High Street, Worle,
Weston-Super-Mare, Avon, U.K.
Tel: Weston-Super-Mare (0934) 516246.
Telex: 45786.



DASH-80

SOFTWARE INCLUDED

CP/M 80¹
 CP/M utilities
 System utilities
 WORDSTAR²
 CALCSTAR²
 PERSONAL PEARL³
 On line HELP file

HARDWARE DESCRIPTION

6MHz Z80B processor
 128k RAM
 Ultra fast 'cache' disks
 One/two 5 1/4" disk drives
 Up to 1568k disk storage
 Two RS232 serial ports
 Parallel printer port



The **DASH-80**, designed and assembled in Great Britain to exploit the vast range of CP/M based application software, provides a processor performance that exceeds that of most current 16-bit systems and floppy disk access times as fast as those of many hard disks.

The **DASH-80** comes complete with a selection of powerful software tools including:

WORDSTAR, the world's most popular word processor software,
CALCSTAR, wordstar compatible electronic spreadsheet,
PERSONAL PEARL, a powerful data base application generator.

DASH-80 processor prices (inclusive of software) start at — **£1084.00** (RRP, excl VAT),
DASH-10 terminal shown above — **£ 560.00** (RRP, excl VAT).

For further information on the system, and for details and listings of disk and processor benchmarks, telephone or write to the address shown below:

PROCESSOR BENCHMARKS

	BM1	BM2	BM3	BM4	BM5	BM6	BM7	BM8
DASH-80	.73	2.4	6.6	6.5	7.0	12.7	20.2	34.3
IBM PC	1.2	4.8	11.7	12.2	13.4	23.3	37.4	30.0
APRICOT	1.5	4.8	10.4	10.8	12.2	22.8	35.5	34.0
SIRIUS	1.7	5.4	11.1	11.5	13.6	26.2	40.1	29.0

DISK BENCHMARKS

	DBM1	DBM2	DBM3	DBM4	DBM5
DASH-80	0.6	4.3	4.2	3.8	3.7
IBM PC	3.8	21.2	20.8	12.7	10.4
APRICOT	3.0	9.5	14.0	8.0	7.5
SIRIUS	2.5	37.0	37.0	12.0	12.0

aculab LTD

Unit A,
 Station Approach,
 Leighton Buzzard,
 Beds. LU7 7LY
 0525 371393



Hashed tables

You can make look-up tables faster and more flexible by coding the entries.

THE TABLE LOOK-UP methods discussed in the first of these articles — *PC* February, page 88 — all have the same fatal flaw. They work fine if the table remains fairly static, but they fall down badly if you need to retrieve entries from the table at the same time as adding new ones to it.

As an example take the problem of text analysis. This is where you count the number of occurrences of each word in a given text in the hope of proving that Bacon really did write Shakespeare's plays. If you tried a linear search to see if each new word had occurred before, the program would take forever. A binary search would be even worse because you would have to re-sort the word list every time you wanted to add a word.

The solution is to use a storage and retrieval method called hashing. It works by converting the value of a word into a numeric address, thereby letting you access the word directly, without reference to any other words in the table. The method is ideal for large, constantly changing lists such as compiler symbol tables or the 1,000-entry directories increasingly found in Winchester disc systems.

To store a word or other symbol in the table, you then use a formula — called a hashing function — to convert the value of the symbol into a number. You then look at the table entry whose index is equal to this number. If the slot is empty, the symbol is stored there. Otherwise, a secondary address must be derived.

The process is repeated a fixed number of times, as defined by the hash count. If you cannot find a home for the symbol after the hash count has been exceeded, the table is declared full.

To retrieve a symbol, the process is similar. The same hashing function is used

to derive the first address. If it contains the required symbol you have a hit; otherwise, keep repeating the process. If you come to an empty slot or if the hash count is exceeded you know that the symbol is not present in the table.

The details of the hashing function can be left for the moment. Of greater interest are the values assigned to the hash count and to the size of the table. The table needs to be larger than the maximum number of entries it is to contain. The proportion of the table that is actually used is known as the utilisation.

With 500 entries in the table, the function must return a whole number between 0 and 499. Here is a suggested method of doing this:

1. Take the ASCII value of each character in the symbol.
2. Divide each value by 16 and take the remainder; in other words, take the bottom four bits of each character.
3. Add the remainders together.
4. Divide by 499. The remainder of this division is the required address.

For example, to hash "MIKE"

1. ASCII values of M, I, K and E are 77, 73, 75 and 69.
2. Remainders after dividing by 16 are 13, 9, 11 and 5.
3. The sum is 38.
4. Remainder after dividing 38 by 499 is 38.

Thus the symbol "MIKE" would be stored in the 38th entry in the table, subject to collisions.

This example assumes that the first entry in the table is at address 0 rather than 1. If this is not the case, the result of the hash would have to be in the range of 1 to 500, so add 1 to the final value.

Figure 1. Hashing procedure.

The higher the utilisation, the greater the risk of collisions, so the higher the hash count must be. But the higher the hash count, the greater the execution time. If the hash count is set too low you run the risk of the table being declared full much too soon. In hashing, the table is considered full as soon as the hash count is exceeded. It rarely becomes full in the true sense.

In practice, a utilisation of between 50 percent and 80 percent is common, with a hash count of about 50. The actual performance will depend partly on the spread of values of the symbols, but at least the algorithm lends itself to fine tuning and experimentation.

The hashing function itself must aim at producing whole numbers between zero and the maximum number of entries in the table. One common method is to combine the ASCII values of the characters in the symbol, then to divide by the maximum value. The remainder from this division is the required address. An example of this process is shown in figure 1.

The hashing function does not have to be reversible. A given address can be derived from many different symbols, which is why there has to be a mechanism for dealing with collisions. Otherwise the table would be gigantic, you would need around half a million entries even if the symbols were limited to words containing exactly four capital letters.

A final question is the method of generating the secondary addresses that are needed when collisions occur. An easy option is simply to use the next free location after the collision. Although this involves a mini linear search the cost is not too high. The best hashing algorithms are designed to reduce the risk of collisions rather than to minimise their effects.

Programming power

ONE OF THE MOST useful programming aids to emerge in recent years must surely be the word processor. After all, source code is not a lot different from any other text, so why not use the power of the word processor to help manipulate it.

This thought struck me the other day while I was struggling with a particularly verbose dBase II program. I needed to write 32 consecutive statements to initialise a number of variables. Each statement was of the form

```
STORE $(SP,1,n) TO FLD:x
```

where n was the length of each of the fields and x was the field number. This construct is similar to the Space\$ ()

function in Basic, the field SP being preset to a string of blanks.

After a bit of thought, I typed the 32 statements like this

```
'n/x
```

Then, with the help of the word processor's global Find and Replace function, I converted every occurrence of an apostrophe to

```
STORE $(SP,1,
```

and every / character to

```
) TO FLD:
```

There must be dozens of situations where using Find and Replace in this way could save time, but clearly the technique has its limitations. An alternative might be to use an ingenious program called Expressbase II, which could prove to be a powerful

productivity booster for dBase users.

Expressbase II is built around two libraries which contain commonly used chunks of dBase source code. They include routines for validating dates, for painting a screen, for displaying routine messages like

Printing in progress and much more. The beauty of it is that you can incorporate any of these routines into your program by means of a simple two-character abbreviation.

There are scores of facilities within Expressbase, and there cannot be many dBase programs that could not make use of at least some of them. Expressbase II is available from Software Ltd, 2 Alice Owen Centre, 251 Goswell Road, London EC1. Telephone: 01-833 1173. It costs £125 plus VAT.

A MULTI-USER BUSINESS SYSTEM FOR UNDER £2,000 PER USER

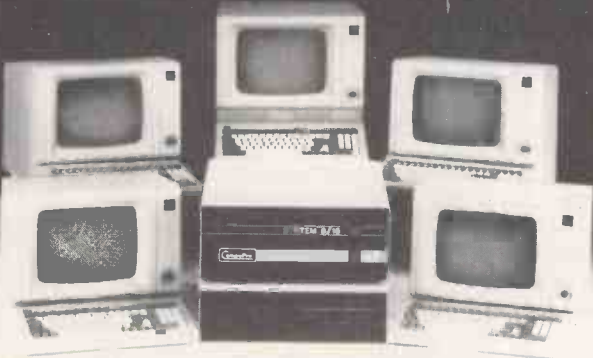

If 21 megabytes of fast storage with five users and two printers sounds useful and £2000 per user seems unbelievable — give us a call and ask us to prove it!

We will explain how your sales clerk, accounts clerk, secretary and you can access your business files at the same time! And there's still that other terminal for expansion!

At COMCEN we make our own computers — Ask our advice — your alternative may be learning the hard way!



COMCEN
TECHNOLOGY LTD

A COMPUPRO
SYSTEMS
CENTRE



Comcen Technology Ltd.
45/46 Wychtree Street,
Morrison,
Swansea, SA6 9EX
Tel: (0792) 796000
(0792) 798337 (24 hours)
Telex 48297 Joytel.

London sales office,
2nd Floor,
Avon House,
360-366 Oxford St.
London W1N 3HA
Tel: 01-491-4636
Telex 28800 Londot

● Circle No. 122

SWAP MICRO TO MICRO FILE TRANSFER SYSTEM

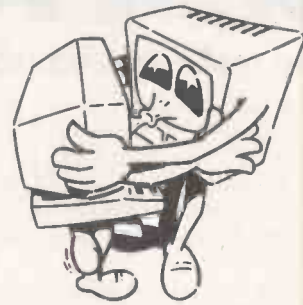

"Get your microcomputers talking to each other!"

SWAP allows you to transfer any programs and data between 2 computers of different manufacture. SWAP consists of 2 floppy disks and a cable configured for your 2 chosen computers. Any combination is available from:

IBM PC
Sirius
Apricot
Superbrain
Televideo

Apple (CP/M)
DEC Rainbow
ICL PC
Rair
North Star Advantage

Tandy II (CP/M)
Comart Communicator
Epson QX10
ECS 4500

The price of SWAP is £158 (£135 plus VAT and postage and packing). Please specify your computers when ordering.

MERCATOR COMPUTER SYSTEMS LTD
3 Whiteladies Road, Clifton, Bristol BS8 1NU.
Telephone: (0272) 731079
Telex 44220 Comtel Ref 247

MERCATOR
COMPUTER SYSTEMS

● Circle No. 123

Ultra-fast BeeBASE -



A machine code database in EPROM (for the BBC Micro) for £45.94*



GCC (Cambridge) Limited
66 High Street, Sawston, Cambridge CB2 4BG
Telephone: Cambridge (0223) 835330

- Up to 25 user-defined fields
- Up to 250 characters in each field
- More than 16K of RAM available for storage (unlimited capacity when used with disk or tape). Extremely fast SEARCH, EDIT, and SORT facilities.
- SEARCH commands include: FIND and EXCLUDE — can be used on up to ten consecutive searches. Enables data to be extracted which meets ALL of the given FIND and EXCLUDE commands. Provides extremely selective data extraction.
- Extracted data can be SORTed on any field.
- EDIT enables records to be deleted or amended (shortened or lengthened).
- An ASCII file of extracted and sorted data can output to disk or tape for storage or further editing by a word processing package (such as Wordwise).
- Includes demonstration cassette which also contains a selective printing program.

Order today — Access and Visa welcomed.

*(Price includes VAT — p&p £1)

Trade and local authority enquiries welcome.

Price correct at time of going to press.



● Circle No. 124

G. W. COMPUTERS LTD

London's West End — Nationwide overnite service — More product ranges —
Probably the widest selection of networks/micros/and printers

WE OFFER ONE OF THE BEST 'SYSTEM DEALS' IN THE U.K. (save 1500.00 +)
THE NEW DBMS III.7 (series III of the world's first 'task-robot-programs')

G.W. COMPUTERS LTD — Tel: 01-631-4818

.....FEATURES.....

Mbasic & word-star compatible
1400 character record sizes
mathematical scratchpad,
record relational indexes,
translateable to any language
User-definable reporting
field protection/classification
either-or, same as, greater, smaller
sorts alpha/numeric any window
12 online file architectures.
240 fields using cross-referencing
cross-record calculations.
"Jump-to" any record in 12 files.
User-define files/field words/sizes.
"purchase/sales-analysis", "personnel-file"

32000 records per filename
20 main/200 sub fields per record. field
and record related formulae.
"Jump-to" any of 3200 records per file.
random/binary/key/multiple field
search. "if-then" questioning
file protection/password entry.
range match, not match, integer match.
sort speed 500 records per 20 seconds
endless 'either-or' matching
formulate/recall on selection criteria.
13 Interrogation question types
short filing output/audit trails.
"sale-mail-shots"; "production-process-
"purchase/sales-analysis"; "personnel-file"

DBMS III 7 new switch mode facility enables you to cross up to 12 different files (32000 records per file) pre-selecting any of up to 20 fields per record/file for display/print output (240 fields) in all. One massive enquiry can pass through 384,000 records

You might have two files whose records are directly related to each other, so that the first file (say containing names and addresses) refers to the second file (say financial and other information relating to the same record numbers in the first file) directly. Then you can simply choose that in file 1 you are interested in just the name and telephone numbers, whereas in file two, you are interested in the income, trading period and number of branches, information. Your enquiry can then pass through both files highlighting that information only. Actually there doesn't need to be a strict correlation between the same record numbers in different files, and you can also just on JUMP command go to any record in any of the 32000 records in any one of the twelve files and carry on cross-referencing from there onwards

DBMS'S MACROS WORK FROM THE MOMENT YOU INSERT THE 'TASK DISK' IN THE COMPUTER

Simply design your file, give its fields your words, set up your report mask, and then enter your records. Switch to "automatic drive" and formulate any task you wish the program to fulfill, the task is stored as a macro. Take a copy of the program on another 'task disk' and from then on, the task disk will function without a single key-stroke. Think of a number of such 'task disks' such as "stock-re-order reports", "stock-valuation reports", analysis, "patient history analysis", "research-analysis", "budgeting", "plus more?"

Not only does this program surpass most of its kind that you might buy elsewhere, but if you buy the hardware from us, then you get it — FREE... DBMS II (WITHOUT MACROS) AND DBMS III ARE FULLY IMPLEMENTED UNDER CPM-86 (tm) AND MS-DOS (tm) ie: < SIRIUS/VICTOR/IBM> DBMS II IS 395.00 (or 250.00 by mail order ex. training). DBMS II IS 575.00 (or 295.00 by mail order ex. training).

Contains the highest state of the art software available today

FORMS/TEXT/CALC/DBMS IV — ALL IN ONE PROGRAM THE "KEY" — @ 575.00.

When you budget for a complete system of software you eventually end up with a host of packages like Sales, Purchases, Nominal Data, Text, Calc, Mailshot, Invoice, Order, Workflow, Personnel, and so on. The list is endless and the outlay several thousands of pounds.

Text. Design a form as wide as a window of 250 characters, long as needed. Cursor movements are 'left, right, up, down, delete left, delete right, tab right-left-up-down'. Paint your form as you like directly on the screen.
Calc. Write a letter as you see it on the screen, edit it then simply enter P to print. Set into the form, your data fields, "#####" and specific file-related activities, formulae and validation checks. Enter values and see the spreadsheet calculate itself.
Database. Search files for data to be inserted to fields specified. All the features of DBMS III, explained elsewhere in our ad.

Here's an example of an invoice you might design for your stationery... You could design your own spreadsheet, order form, statement, wage docket, or any other kind of form that is required to fit your existing stationery.

INVOICE				
To	<1>	From:	G. W. Ltd	
<2>			55 Bedford Court Mans.	
<3>			Bedford Avenue	
<4>			London W.C.1	
<5>			Tel: 01-636 8210	
Date	<6>	Tax point	<7>	Agent
Quantity	Description	Cost	Tax	Total
<9>	<10>	<11>	<12>	<13>
<14>	<15>	<16>	<17>	<18>
Total		<19>	Tax	

<??> Items <1> to <5> Internal command to request name, input, and then search an address file for details.
<??> Items <6> to <7> request date input and validate.
<??> Item <8> request agent number and validate range.
<??> Item <9> request quantity, validate range.
<??> Item <10> request description, search file, accept, and calculate fields <11> <12> <13>. If finished invoice then calculate fields <19> and <20>

Now comes the more valuable facility. You can provide the 'FORM' with file-related instructions, not only to request a 'console' input for file search against names, and stock, but after the invoice is finished, the fields you have selected may be passed to related files.

EG: Send fields <0>, <1>, <06>, <07>, <11>, <12>, <13>, <19>, <20>, to a sales ledger.
Then send fields <9>, <10>, <11> to product analysis file.
Then send fields <0>, <1>, <7>, <19>, <20> to V.A.T. file.
Then send fields <10>, <11>, <12>, <13> to Nominal ledger. Do you see?

SYSTEM DEAL (our speciality) SAVES YOU 1500.00

Buy any computer, any printer and 150.00 value diskettes add 85.00 for cables and testing.
add 10% for return to base warranty for 1 year (optional) add 110.00 for delivery & installation (optional)
training optional extra 120.00

and get completely FREE

cpm handbook	.50 basic exercises	.2000 sheets paper
DBMS III.7	.magic wand w/proc	.magic calc
mbasic 80	.diagnostics	.msort/dsort
recover	.autoload	.instant basic
library boxes	.disk/games	.DT/AS/NS sorts

total value 1525.00

Based on 8 bit hardware, 16 bit software varies!

Here's a typical example of a complete system deal

1—IBM PC or Corona Portable	2595.00
2—Oki microline 80 printer	295.00
3—Cables & testing	85.00
4—Diskettes	150.00
5—price differential on magic/wand for word-star	100.00

software described above FREE 3225.00

We specialise in 'STANDARD MICRO-PRINTER SYSTEMS' as well as 'NETWORK SYSTEMS BASED ON A SHARED HARD DISK'

The range of computer products (mostly ex stock) includes the most popular brands of micro-computers, printers, modems, buffers, spoolers and software.

POPULAR BRANDS OF EQUIPMENT WE SELL

MICROS — Sirius/Victor/I.B.M./Dec/Epson/North-star
— Sanyo/Superbrain/CompuStar/Altos/Apple/Lisa
— Televideo/Corona/Compaq/Eagle

PRINTERS — Nec/Quem/Diablo/Okii/Epson/Olympia/Ricoh
— Texas/Dre/Anadex/Others

OTHERS — Convul/CompuStar/Syquest
— hard disks networks and multiplexors
— Spoolers/Modems/Buffers
— most of the best known brands of software

Syquest 5.6MS cartridge drives on I.B.M. PC.

Remember! the software is the 'key' & the hardware less important.

TERMS & ETC

G.W. Computers Ltd [Grama (Winter) Ltd]
43/55 Bedford Court Mansions
Bedford Avenue
London W.C.1 England
Telex 892031 TWC G

Telephones:
01 636-8210
01-631-4818

Boston office tlx 94 0890

24 hour answerphones: leave address for 'in'packs'. We do not operate a reader's reply card service. Terms: C.W.O. or C.O.D. Prices exclude V.A.T. but include all non-credit discounts available. No dealers! The above lists are not exhaustive. Please call at our showroom only by prior appointment. Unless expressly agreed, all warranties are commercial 90 days return to base for parts and labour. Annual warranties and maintenance facilities available nationwide through closely related third parties.

aculab

data buffers

FROM 16K TO 256K

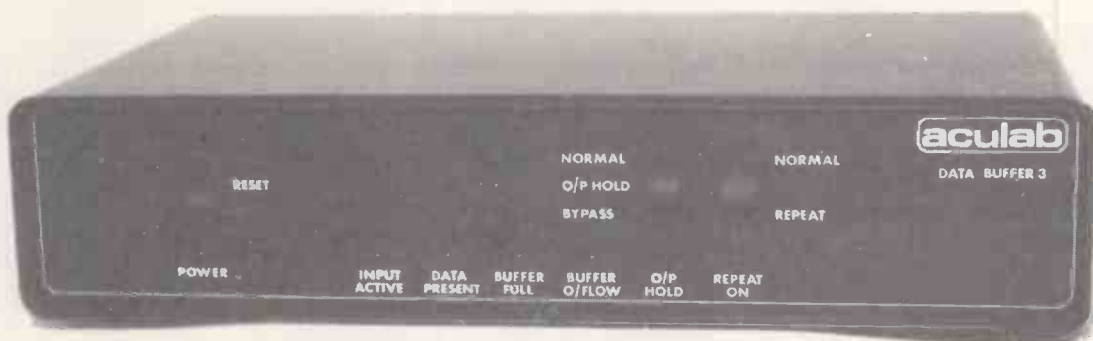

Any combination of Parallel or Serial inputs and outputs, capacities 16k, 32k, 64k, 128k and 256k. Status indicator led's for data arriving, data present, buffer full etc. Buffer bypass facility for 'quick print' jobs, buffer repeat facility for multiple copies. Output hold facility to temporarily stop printing without destroying data. Separately selectable DTR, XON/XOFF, ETX/ACK handshaking, baud rate etc. on serial inputs and outputs. Serial input and output selection provides return data channel for KSR printers. Use for printer 'spooling', protocol conversions, data acquisition, machine monitoring etc.

For further information telephone or write to:

aculab Ltd.

Parallel in—Parallel out	DB3-1	from	£186.00	(excl VAT)
Parallel in—Serial out	DB3-2	from	£197.00	(excl VAT)
Serial in—Parallel out	DB3-3	from	£197.00	(excl VAT)
Serial in—Serial out	DB3-4	from	£203.00	(excl VAT)
Parallel/Serial in and out	DB3-5	from	£221.00	(excl VAT)

Unit A, Station Approach,
Leighton Buzzard,
Beds. LU7 7LY.
0525-371393

● Circle No. 127

SUSS BOX

The DUPLEX SUSS-BOX and DUPLEX SUSS ADAPTOR have been designed to enable the less skilled computer user to have a better understanding of the correct working connection between a computer and a peripheral, such as a printer. This is achieved by using the commonly used signals (wires) of the RS232C serial data cable specification, a matrix block and special connector pins. By inserting the connector pins into the SUSS-BOX's matrix block at the axis of two incoming signals the user can quickly establish a firm connection. The signals are routed into the SUSS-BOX by two 25 way D type connectors, 1 x female, 1 x male. The SUSS-BOX also provides a lamp for each signal to show its condition when connected in-line, i.e. High or Low.



SUSS ADAPTOR

When the user has achieved the correct 'Pin out' between a micro computer and a printer the DUPLEX SUSS ADAPTOR should be used as a permanent means of connection. This is done by transposing the correct matrix block pin-layout already established with the SUSS-BOX onto the matrix-block of the SUSS ADAPTOR, and then installing the SUSS-ADAPTOR in between the computer and printer.

£29.95
+ £1.00 p&p
+ VAT



South—52 High Street, Stock, Essex CM4 9BW, Tel 0277 841011

Midlands/North—2 Leire Lane, Duntun Bassett, Nr. Lutterworth, Leicestershire LE17 5JP, Tel 0455 284298

All prices are based on cash-with-order terms

SUSS BOOK

2nd edition

If the user specifically wishes to connect a microcomputer to the OCTET or HERMIT typewriter/printer then refer to DUPLEX'S SUSS BOOK for details on various microcomputer cable Pin-outs

£6.95
+ £0.65
+ p&p

A+G COMPUTERWARE

* ALL THE BEST FROM A + G *

APPLE SOFTWARE

Send now for new 1984 catalogue
Over 700 items Lots of new bargains
Write or call now

PRINTER BARGAINS

New Daisystem 2000 Daisywheel Printer
Wordstar compatible Bidirectional 20 CPS
Oume Ribbons and Printwheels
Free delivery on UK mainland
at only £289!!
Full warranty,
Unbelievable value!

Business Starter Pack
Based on Apple IIe computer plus all necessary cards & cables includes *Monitor* D/Wheel Printer and Software.
Inclusive Price £1679
Ask for details

Stock Clearance — Epson MX100 FX/3
Limited number available @£348!!
Also RX80 @£225 and RX80 F/T @£243

Monitors Green — Amber — Colour
Acoustic hoods for all makes of printers
printer buffers — internal — external — 2K to 64K
2 years guarantee
All at amazingly low low prices

DO IT NOW! RING FOR OUR BARGAIN OFFERS

Govt. & Educ. orders welcome.
Free delivery by Interlink Courier
Please add VAT to all totals

P.O. Box 34, Cheadle, Cheshire, SK8 4PT
Telephone 061-428-2014



● Circle No. 126

● Circle No. 128

ATA

The market leaders!...



NEW!
apple HOME COMPUTER PACK

Apple IIe Computer Disc Drive with Controller, T.V. Modulator, Apple Books, Software Vouchers + FREE Apple Sports Bag

ONLY £759
ring 01 833 0044 for latest PRICES

Attention Dealers!
As a result of demand ATA UK has been established to supply dealers, computer products at attractive prices.
Ring Now (dealers only).
(0727) 37327
(0742) 700802

Export specialists — ring or telex for details

...with recognised professional support



Apple Hardware

Apple IIe

Apple IIe 64K	499.00
Disk drive with controller	250.00
Disk drive	199.00
Apple IIe minotir	125.00
Phoenix hi-res green 12" monitor	99.00
Phoenix hi-res amber 12" monitor	105.00

Apple III

Apple III 256K including Monitor III, Disk drive & SOS	1980.00
Additional 5.25" disk drive	270.00
Profile 5mb Winchester	1299.00

Accessories

80 column card	65.00
80 column card 64K extended	145.00
Numeric keypad (I/e)	85.00
Numeric keypad (III+)	75.00
T.V. modulator with sound	12.00
Videx Videoterm 80 column card	195.00
Videx Soft Switch (40/80 column)	20.00
Videx Keyboard Enhancer	87.00
Videx Inverse ROM and character sets	18.00
Microsoft Softcard (Z80 CP/M)	220.00
Microsoft Softcard Apple III (Z80 CP/M)	265.00
Accelerator card (3.6 mHz 6502C & 64K)	289.00
Joystick (I/e)	29.00
System Saver fan & voltage reg.	59.00
Dust cover for Apple II	6.50
Dust cover for Apple II 2 x DD & 12" minitor ..	9.00
Dust cover for Apple III & Monitor III	11.99

Colour Monitors

Luxor high resolution	
25Mhz linear & TTL	499.00
Kaga Denshi medium resolution TTL	325.00
Kaga Denshi low resolution	265.00

We also stock the Hantarex RGB monitors, as recommended by Apple in Europe.

PRICES EXCLUSIVE OF VAT AND CURRENT AT TIME OF PRINTING

Interfaces

Apple RS232 Super Serial card	99.00
Apple IEEE 488 card	205.00
Apple parallel interface with cable	99.00
Apple III parallel interface with cable	130.00
CCS 7710-01 RS232 serial interface	109.00
Grappler + parallel graphics interface	105.00
PACT 8 bit A/D converter	115.00
Keyzone 12 bit A/D converter	138.00
PACT 12 channel D/A converter	125.00
RGB card TTL/analog output (programmable) ..	99.00
RGB card TTL output	85.00

Macintosh

Macintosh the ultimate business machine.
32-bit MC68000 microprocessor
400 kilobyte 3 1/2 inch disk
The Mouse Replaces typed-in computer commands with a form of communication you already understand: pointing
Nineinch high-resolution (512 x 342-pixel) bit-mapped display
RAM 128 kilobytes
ROM 64 kilobytes
Completely portable

Robocom Bit Stik C.A.D. Graphics System

Robocom Bit Stik 1.1 system	390.00
Robocom Bit Stik 1000 upgrade software ..	350.00
Robocom Bit Stik 1000 system package ...	545.00
Plotter driver for A4 and A3 plotters	180.00

Printers & Plotters

Epson

Epson RX80 120 CPS	245.00
Epson FX80 160CPS	349.00
Epson RX80FT	265.00
Epson FX100 160CPS	480.00

Apple

Apple Dot Matrix 120 CPS	349.00
Apple Letter Quality Printer	1199.00

Ricoh

Ricoh 1300 Flow Writer	1150.00
Ricoh RP1600 Flow Writer	1499.00
Mannesmann Tally MT160L	449.00
Mannesmann Tally MT180L	649.00
Plus full range of Centronics Printers Available.	

Plotters

Hewlett Packard HP7470	750.00
Hewlett Packard HP7475(A3) TBA	1399.00
Calcomp 8 PEN (A3)	2999.00

WE ALSO STOCK APPLE AND HEWLETT PACKARD

TERMS AND CONDITIONS

For delivery please add
£0-£199 + £5, £200-£1499 + £13,
£1500 + 1 1/2%.

CHEQUES WITH ORDERS

Please allow 10 days for clearance.
PLC's, public sector etc 30 days
credit available on official orders,
subject to 5%
credit charge.



ATA — LONDON 4 Albion Hse,
1 Back Hill, London EC1. 01-833 0044

Telex 25102 CHACOM G

ATA — ST ALBANS Adelaide
House, 9 Adelaide St, St Albans,
Herts AL3 5BE. (0727) 34361

ATA — SHEFFIELD 72 Eldon Street,
Sheffield, S1 4GT. (0742) 700802

FREEPOST SHEFFIELD S1 1AY

Order your
Macintosh™
NOW TO ENSURE DELIVERY

ATA

It Reads, Writes and It Paints in 3-D, Keeps and Talks to

It's called "OPEN ACCESS," and it's the result of 60 man-years of effort to create a truly do-it-all, super-program—one that can perform virtually every task you're ever likely to encounter.

The beauty of it is, all that capability resides on a single program. You don't have to re-enter data. Or spend time trying to get unmatched programs to work together.

OPEN ACCESS takes its name from the source of its power—a relational data-base manager that gives you access to more data in more ways than any comparable software.

OPEN ACCESS includes an electronic spreadsheet, 3-D graphics, word processor, appointment scheduler and telecommunications module—all revolving around the powerful information manager.



1



INFORMATION MANAGEMENT—THE MASTERMIND. This advanced data-base manager stores and retrieves multiple files quickly, easily and reliably. What's more, it shares all information with the other programs, so you never have to re-enter the same data twice.

2



ELECTRONIC SPREADSHEET—NUMBER CRUNCHING AND GOAL SEEKING. It helps you produce forecasts, cost estimates and "break-even" points—in seconds, instead of hours or days. Best of all, it allows "goal seeking." Ask, for example, "What sales must I have the rest of the year to net \$1 million?," and OPEN ACCESS will figure it out!

3

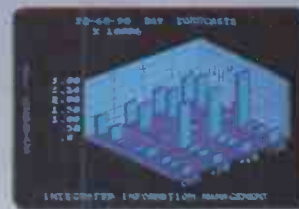

3-D GRAPHICS—NOT JUST PRETTY PICTURES. These graphics distill raw data into trends that can be instantly visualized, helping you discern the important facts from a wealth of information.

does Arithmetic. Your Appointments the World.

Because they do not have a dedicated relational data-base manager that can quickly direct massive amounts of data, other programs simply can't do what OPEN ACCESS can. Some don't have a communications program, others no dedicated word processor. None have a time management program.

There's just one conclusion: At £ 495.—, OPEN ACCESS can do more for you than any other comparable business program on the market. Bar none. But the only way for you to be convinced is for you to see OPEN ACCESS work its magic on your work load. So call your local software dealer today, or call us.



SPI SOFTWARE PRODUCTS INTERNATIONAL

European Headquarters: Amsinckstr. 44, D-2000 Hamburg 1,
Tel.: 40 / 23 60 06-0, Tlx.: 2 17 773 spih d

4

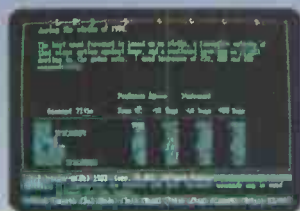

WORD PROCESSING—EDITOR
EXTRAORDINAIRE! Superior word processors make it easy to correct typos, change words, shuffle paragraphs and format documents. This is one of that breed. Use it to write efficient memos, letters, proposals and reports.

5

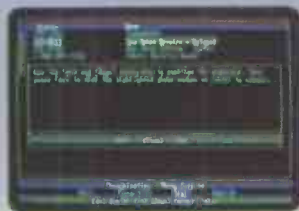

TELECOMMUNICATIONS—YOUR LINK WITH THE WORLD. This program gives you access to virtually any other computer system in the world. Not only can you transmit and receive reports from your colleagues, you can also subscribe to special data banks that know everything from GM's stock price to the relative humidity in Genoa. Now that's power!

6

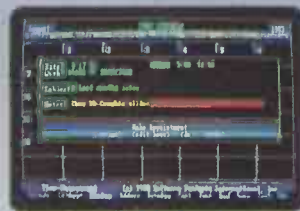

TIME MANAGEMENT—CONSERVING YOUR MOST PRECIOUS RESOURCE. This module helps you keep track of all your appointments hour by hour, day in and day out. It alerts you to standing obligations, automatically coordinates meeting times with other busy professionals, and lists all your associates on a Rolodex™-like file.

● Circle No. 130

Distributors in the UK:
SOFTSEL™, Softsel House, Central Way, North Feltham Trading Estate, Feltham Middlesex TW 140XQ, Tel.: 01 - 844 20/40
Xitan Ltd., Xitan House, 27 Salisbury Road, Totton, Southampton, SO4 3HX, Tel.: 0703 - 871211



PHILIPS

Every small business can be a step ahead with The Philips Portable Computer P2000 C

The P 2000 C goes from desk to desk providing computer efficiency to many people in a small company. The P2000 C portable is easy to move and can be set up in a flash. And it is easy to use even if you have never used a computer before.

A secretary can type with the P2000 C just as with a typewriter only it's faster, easier and better. You can organize your records with it, do forecasts, projections and estimates, analyze

your costs and prices. The accountant can do his bookkeeping and billing and keep track of outstandings. In fact any business task can be done more easily and quickly.

Feature Highlights

1. 9" screen, 24 x 80 display, 32 KB video RAM
2. 64 KB RAM user memory, 256 KB RAM disk optional
3. Two 5 1/4" floppy drives with up to 640 KB per disk
4. CP/M* and p-System** provide access to a large range of available software
5. Interfaces: serial printer, external floppy drives, hard disk, data communication, slave monitor, IEEE-488

* CP/M is a trademark of Digital Research Inc.

** p-System is a trademark of Softech Microsystems Inc.

P2000 C – the affordable portable. With free software. Plus SAGE Accounts Packages on Free Trial.

Contact our distributors for a list of dealers in your area.

KINGSWAY DATA 2000 C DEALERS

Chas White and Son Ltd
2-6 Curtain Road
London
EC1V 2AA
01 920 9831
Harpers Computers
71-73 Commercial Way
Woking
Surrey
GU21 1HN
04862 25657

C&L Computers Ltd
St John's House
Grover Walk
Corringham
Essex
0375 675656

Anchor Computers Ltd
Rovert House
Station House
Hucknall
Notts
NG15 7UD
0606 640220

De Trey Computer Services Ltd
272 Old Birmingham Road
Rednal
Birmingham
B45 8EY

Midland Analytical Services Ltd
Unit 4
Coppice Lane
Walsall
West Midlands W39 9AA
0922 58247

Anglia Telecommunications
(Peterborough) Ltd
3A High Street
Market Deeping
Peterborough
PE6 8ED
0778 346633

4B Microcentres Ltd
North Bar
Banbury
Oxon
DX16 0TF
0295 67551

Computers For Business
Middle Rixdale
Luton

Nr. Newton Abbott
Devon
0626 88247

Skytronics Ltd
357 Derby Road
Nottingham
Notts
NG7 2DZ
0602 781742

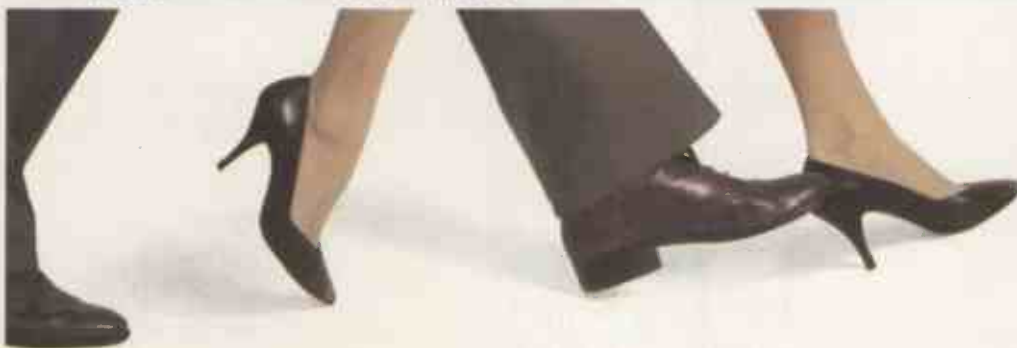
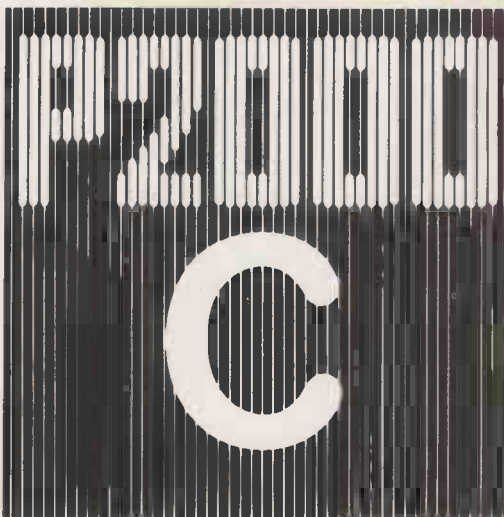

For Dealer Enquiries.
Contact Kingsway Data, 30 Guildford St. Chertsey, Surrey. Tel Chertsey 68911

● Circle No. 131

£350

ESSPLOT 2

THE GRAPHICS PACKAGE ON
IBM PC, APRICOT, RAINBOW, SIRIUS SAMURAI
AND OTHER INTEL 8088/86 COMPUTERS.

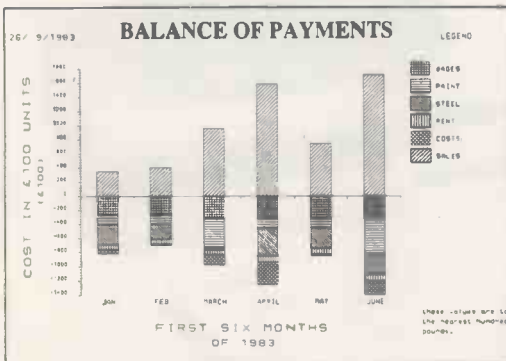

BAR CHARTS

- * STACKED BAR CHART
- * SIDE BY SIDE
- * THREE DIMENSIONAL
- * SPLIT AND LINE
- * UP TO 20 BARS
- * UP TO 6 VALUES EACH

GRAPH PLOTS

- * SPLINE CURVE
- * BEST CURVE
- * BEST LINE
- * SHADED LINE PLOT
- * SCATTER PLOT
- * 6 LINES/CURVES
- * LINEAR/LOG/NLOG SCALES

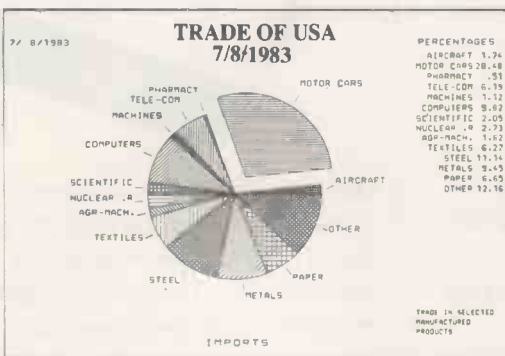
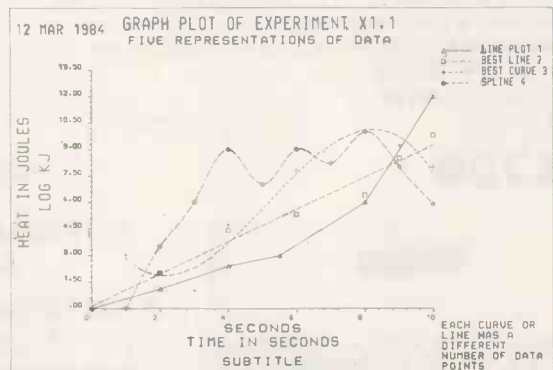

PIE CHARTS

- * UP TO 4 PIES PER CHART
 - * 20 SLICES PER PIE
 - * PERCENTAGES
- ## SLIDE SHOW
- * FULL SLIDE SHOW FACILITIES
- ## DATA FILES
- * DIF, MULTIPLAN LINK AND ASCII
- ## INTERFACES
- * COLOUR CARDS eg PLUTO
 - * A RANGE OF GRAPHICS PRINTERS

PLOTTERS

HEWLETT PACKARD: COULD BRYAN: C-ITOH: WATANABE: TEKTRONIX HILOT
CAL-COMP: NICOLET ZETA: DIGILOT: MANNESMAN TALLY: ROLAND: HITACHI.

REQUIRES MS-DOS AND 256K BYTES OF RAM.

ALL ENQUIRIES INCLUDING DEALER/DISTRIBUTORS TO JOHN R. NUTBOURNE.

ESS CONSULTANTS LTD
35 CHENEY WAY
CAMBRIDGE CB4 1UE
Tel. (0223) 351196

DEMONSTRATION PROGRAM is available on loan for up to 28 days. This is a full program with just the words DEMONSTRATION PROGRAM inscribed on the graphics, for you to assess the full capabilities of the product in your own environment.

16 BIT COPAM INTELLIGET PC-301 PERSONAL COMPUTER

PC301 SPECIFICATIONS:

Microprocessor: Intel 16 bit CPU 8088
 Operation System: MS DOS 2.0
 User Memory: 128K Expandable to 512K
 Disk Drives: Dual DSDD 720 Kbyte
 Interface: 2 Serial RS-232 Port
 1 Parallel Centronics Port
 8 Expansion Slots
 Power Supply: 100W Enough to Support Hard Disk
 Keyboard: Capacitor Type 50 Million Strikes
 Resolution: 640 x 400 Dots with 16 Colours
 Calendar Clock

SOFTWARE

COPAM INTELLIGENT PC-301 uses the MS-DOS 2.0 as operating system.

COPAM INTELLIGENT PC-301 can be used to run countless package those are designed under MS-DOS such as 1-2-3, Multiplan, Wordstar, VisiCalc, DBASE II, Copy II PC... etc. IBM PC compatible package can be used on CPAM INTELLIGENT PC-301, this compatibility will assure you the ever increasing supply of more powerful package in the future.

The CP/M-86 will run the COPAM INTELLIGENT PC-301, the meaning of this compatibility is the software which developed under CP/M-86 can be used on the COPAM INTELLIGENT PC-301.

AVAILABLE SOON IN
 LANGUAGE

انگلیزی - عَرَبِي

£1750

(without monitor)



G BASE-64A

Dual processor Z80 and 6502 based system with 64K memory expandable to 192 Kbyte. Keyboard: 72 typewriter style ASII keyboard. 63 function keys, 31 one key command, all with upper/lower case function. Built in mini-writer. Self-test to check Rom, sound, pattern, color and Ram. **£320**
 Also available in

انگلیزی - عَرَبِي

INTERFACE CARDS FOR APPLE™

- 8088 processor card for Apple™ PC to run the DOS 2.0 and CP/M-86 operating systems software **£350**
 - Z80 card **£42**
 - 80 column card **£49**
 - 128K Ram card **£180**
 - RS232 **£35**
 - Eprom writer card 2716, 2732, 2764, 2516, 2532, 2564 **£40**
 - Printer buffer card. From **£65**
 - PAL colour card **£59**
- Other cards: 6809 card, IEEE 4888 card, Wild card, Music card, 16K Ram card & Communication card. From **£35**

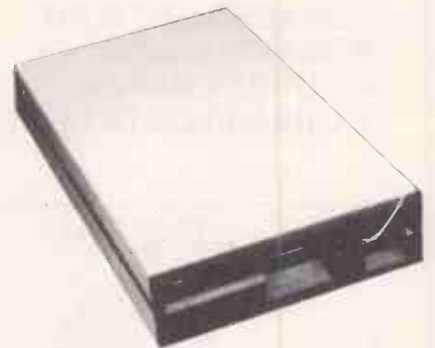

Multitech slimmer half-height 5.25-inch minifloppy disk drive, 100% high quality, Apple™ II compatibility. This slim, stylishly designed drive provides 143 Kbytes of storage with 35 track compatibility. The slimmer provides a 34 pin standard format interface for use with the IBM™ PC. **£175**

DEALER ENQUIRIES WELCOME

PRICES EXCLUDE VAT, P&P. SPECIFICATION SUBJECT TO CHANGE

SOLID STATE NUTRONICS LTD

70 BROOKWOOD ROAD, LONDON SW18 5BY
 TELEPHONE 01-788 1982 TELEX 8812093 NUTRONG

Personal callers to: VISIONSOUND, 251C-253 Wimbledon Park Road, London SW19.
 Southfields District Line Station

Portables, pirates and prices

IBM in Boca Raton, Florida has announced the IBM Personal Portable Computer. It should be on sale now in the U.S., though no one knows when it will reach the U.K.

The machine weighs about 30lb., measures 20in. by 17in., comes with a carrying bag and costs \$2,795. It has 265K of RAM, a 9in. amber screen, and a single 360K half-height floppy-disc drive.

The Portable Personal is IBM's reply to Compaq, which

has sold \$100 million worth of portables in the U.S. and has just launched its machine in the U.K. After all, who can make a more compatible portable than IBM?

Certainly IBM is out to protect its position by defending its copyright code. The company has recently sued two makers of IBMulators, Corona and Eagle, and forced both to rewrite parts of the BIOS. Further, IBM has placed advertisements in Hong Kong

newspapers warning counterfeiters that they will be prosecuted.

Meanwhile, IBM has reduced the price of the PC in the U.K. by over 20 percent, and the XT price is down by around seven percent. "This action", says IBM, "reflects improvements in manufacturing ... in Greenock, Scotland."

Cutting prices to keep the bandwagon rolling is something IBM has already done more than once in the U.S. Again

IBM is turning the heat on rival suppliers who do not have the volume to compete.

● IBM's corporate results were announced in last month's IBM News page. Now IBM United Kingdom has declared its own results. Sales were up by 35 percent to £1.677 billion, while profits were up 30 percent to £255 million. Exports rose by 43 percent to £745 million — Greenock, remember, makes PCs for most of Europe and North Africa.

Accent on comms

NEWLY FORMED Accent Computers is importing the Forte PC78-2/3/4 package which includes both hardware and software for connecting an IBM PC to a 3270 network. It provides full emulation of a 3278 or 3279 terminal and communicates via a co-axial cable.

Another Accent import is VLSI's low-cost LAN for connecting up to 255 IBM PCs together. Software provided includes drivers for the Apple II and versions of CP/M for S-100 bus micros, as well as the expected 8088 version for the IBM PC.

Accent can be contacted at 01-370 0862 pending the opening of a new office in Haywards Heath.

Another new company specialising in comms is Techland International, an offshoot of Techland Systems of New York. The range of Blue Lynx products provides software and hardware to link PCs to IBM System 34, 36 and 38, to provide 3270 emulation, and VT-100

and VT-52 terminal emulation.

Contact Techland International at Weybridge House, Cores End Road, Bourne End, Buckinghamshire SL8 5HH. Telephone (06285) 26535.

Irma is a board from TAC of Georgia which links an IBM PC to a 3270 controller — and it handles all the protocols. The importer is Pete & Pam Computers. Telephone: (0706) 212321.

Microtrend U.K. has announced Trendterm/3780, which runs under PC-DOS and allows communication with mainframes, or micro-to-micro links. Contact Microtrend at (0423) 711878.

PC Comm is a package from Lion Micro Computers, which is now specialising in comms. It has a built-in text editor and allows communications with IBM mainframes and electronic mail services, or turns your PC into a telex machine. Lion claims over a thousand Comm installations on various machines, and is looking for dealers for the PC version. Telephone: 01-580 4581.

Hogan Systems has launched Hits, the Hogan Interactive

Telecommunications System, which links an IBM PC to Hogan's mainframe computers in Dallas. Telephone: 01-439 6288.

Last but not least, IBM can now supply a program which allows the linking of an IBM PC to IBM System 34, 36 and 38 computers by providing 5250 emulation. You need DOS 2 and at least 128K of RAM.

Level II Cobol

MICRO FOCUS has announced High Performance Level II Cobol for the IBM PC. It includes a native code generator, which takes the intermediate code produced by the compiler and translates it into machine code. Micro Focus claims that most programs run from three to six times faster after translation, and some up to 15 times faster.

H/P Level II Cobol has the same PC-specific features as Personal Cobol, launched last year. H/P Level II also works with the programming tools Forms-2 and Animator the new Animator package being, again, customised for the PC.

Contact Micro Focus Ltd, 26 West Street, Newbury, Berkshire RG13 1JT. Telephone: (0635) 32646.

Multimate

MULTIMATE is a much better word processor than was suggested in *Practical Computing's* review, published on page 60 of the March issue.

It is not actually page-orientated at all: the review sample was page-orientated because that had been selected as a default, and as a spokesman for Softword Systems points out "Nobody does that!" Complaints about waiting while text is saved to disc become void, though saving each page automatically remains a useful option when the security of your text is at a premium.

It is also possible to run the spelling checker from inside a document, and the package requires 256K not 128K. An English-language spelling checker is now available, as is a template for people who do not want to put sticky labels on their keycaps.

Multimate is available in the U.K. from distributors including Pete & Pam, Ferrari and Softsel, or contact your local IBM PC dealer.

Plug-in 53Mbyte

LEGEND DATA PRODUCTS can now supply a 53Mbyte hard disc add-on which plugs straight into an IBM PC. It also provides automatic back-up with a removable cartridge disc facility. The styling currently matches the PC system box, and later versions are planned for other micros including Apple, Sirius and DEC.

Contact Legend Data Products, 13 St. John's Road, Harrow, Middlesex HA1 2DF. Telephone: 01-861 0863.



Irma links the PC to a 3270 controller.

A new accent on PC performance

These instantly installed plug-in expansion boards offer major functionality enhancement for the IBM PC and other micros. They come with full software support on floppy disk.

FORTE MODEL PC 78

Gives your PC direct access to your mainframe (IBM 43xx through 30xx). A single plug-in board connects to your IBM 3274/3276 Cluster Controller via existing coaxial cable. No extra phone lines, modems or peripherals.

Entire functionality on floppy disk, no PROM changes.

- Parity check memory on display RAM.
- Complete configuration from keyboard.
- Re-configures colour attributes to taste.
- Choice of Basic or C, with broad sub-routine library.
- Serial interface.
- User-friendly, high-speed file transfer.

PARADISE MULTI-DISPLAY BOARD

Saves a slot in the PC. Colour display controller, monochrome display controller and printer interface all on one plug-in board.

- Compatible with PC/XT and all the best productivity software.
- High-resolution colour graphics, fully IBM compatible.
- 2 pages of high-resolution graphics, facilitating animation or high demand graphics operation.

- Flicker-free scrolling, even in colour.
- External switch or software control for monochrome or colour mode.
- IBM character sets and test modes.
- Compatible with widest range of RGB and composite video monitors.
- IBM type printer port.
- IBM-compatible light pen and RF modulator ports.

VLSI 1553-NET

The ultimate in user-friendly Local Area Networks (LAN's) – very low cost, very high speed, plus reliability that approaches a $1.0E^{-17}$ bit error rate.

- Connects IBM PC, Apple II/IE and any S100 bus micro.
- 3 megabit/sec transmission rate, operating at around 15% utilization and giving a throughput which approximates to that of current 10 megabit bandwidth LAN's.
- Superior error checking, collision detection and collision avoidance.

- Lives entirely within constraints of host operating system, preserving upward compatibility; e.g. the interface to the IBM PC is at the ROM BIOS level.
- Simple coax connection.
- Up to 4000 feet, without the use of repeaters.
- Protocol entirely contained in software, permitting various implementations of LAN protocols.
- Variable blocks sizes supported, from 20 bits to over 64K bytes.

ACCENT ON PERFORMANCE

Accent Computers is a new European force in specialised hardware distribution, bringing you selected state-of-the-art products from some of the world's most innovative designers and manufacturers.

Dealer Enquiries Welcome

46
Accent

Accent Computers Ltd
PO Box 62 London SW10 9LT
Tel: 01-370 0862

Accent Accent Computers Ltd
PO Box 62 London SW10 9LT
Tel: 01-370 0862

To Accent Computers, I would like further information on:
FORTE MODEL PC78 VLSI 1553-NET Please tick PC5
Name _____
Company _____
Address _____
Telephone _____

THE SALES EDGE

Paul Braybrooke and Jack Schofield tackle a new package designed to smarten up your selling techniques.

THE SALES EDGE, one of a suite of five business packages from the Californian software company Human Edge, is designed to help people to sell. The program advises on opening and closing strategies to use in negotiations, and on how to overcome objections to buying the product or service.

Both the program and the manual are written for non-technical users, so all you have to do is boot the first of the three discs supplied, then follow instructions. The package also includes a 50-page sales-aid supplement and 50 Buyer Work Sheets. These are assessment forms for use after sales meetings, and encourage you to record details of your client's character for analysis at a later date.

After you insert the disc the program boots automatically and presents a menu with four options: Instructions, Self Assessment, Client Assessment, Print Sales Strategy Report. The Instructions section briefly outlines the contents of the manual, so you know what to do next to continue the program.

Personality

In the Self Assessment section, which must be done first, you are asked to respond to a series of 84 statements, using the cursor-control keys to select Agree or Disagree. The statements are supposed to provide enough information about your personality traits for comparison with those of your clients.

In stage 2, Client Assessment, you respond to statements about a particular client to enable the program to assess his or her strengths and weaknesses, likes and dislikes. In this case you might want to return to previous screens to amend the results, if necessary. This can be done with a few keystrokes.

The final part of the procedure involves switching to the third or output disc and waiting while the program compares your character traits with those of the client. Reports normally comprise about five pages or more of single-spaced copy, broken down into several sections: What to Expect, How to Succeed, Customer-specific Opening Strategies, Customer-specific Presentation Strategies and

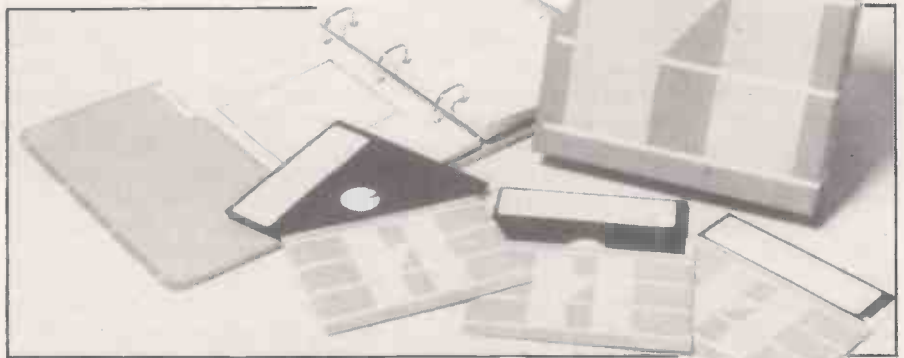

The documentation is designed for non-technical users.

Customer-specific Closing Strategies. The program usually offers four or five different closing strategies per client.

The conclusions of the Self Assessment section are not directly available to the user. Your only guide to what the program thinks of you are in the final report, but the statements are direct, and seem to be consistent from report to report.

Three different people looked at this aspect of the package, and all agreed the results were fairly accurate. This kind of psychological testing is well established, particularly in the States, so it would be surprising if the results were not acceptable. But The Sales Edge did not proffer comments like "You are a wimp and ought to give up selling", and few people will reject a character analysis that shows them in a basically favourable light.

The assessment of different clients was also thought to be fairly accurate, and here the program's versatility was quite surprising. You would expect it to trot out a limited number of fairly standard character types, but it really does seem to construct a new and individual one for each client.

With the few clients tried in the short time the package was available, there were no cases where the program offered a strikingly different analysis of the client, or proposed a dramatically different approach from the one that would have been taken anyway. In practical terms the advice given seemed to make sense, though again it is mainly feeding back the user's own view of the client, so it would be surprising if this were not the case.

Much of selling is to do with perceived, rather than actual, relationships and it could be argued that it is the salesman's

perception of the client which is the relevant one. So is The Sales Edge any use at all? In practice, it is. The mere fact of sitting down, thinking about the needs of the client, and thinking about a structured approach to the sales meeting is valuable in itself. The advice given can also be useful too, though there are numerous American books on salesmanship available for 1/10th of the price of this package.

In any event, The Sales Edge is an interesting package which will no doubt gather some followers and many imitators using the same or similar techniques. Human Edge will itself be following up the package with The Management Edge, The Negotiation Edge, The Communication Edge and The Leadership Edge.

Conclusions

- The Sales Edge is unusual for a business package in being fun to use. Early trials suggest it can be useful in practice, but the long-term usefulness probably depends on the person using it.

- At £249 plus VAT the price seems reasonable compared to the potential profits. American sales techniques can be learned more cheaply from a book, though this does not provide the individualised advice that is The Sales Edge's strong point.

- The package only runs on the IBM PC and its look-alikes, but is promised for the Apple Macintosh and may be available for other machines if there is a demand for it.

- The Sales Edge is imported and distributed by Marketing Software Limited, 28 Colhill Gardens, London SW6 6SZ. Telephone: 01-731 3083.

Faster disc accesses

Paul Myerscough explains pointer chaining, and presents a simple database management program which implements the technique on the IBM PC.

PHYSICAL I/O has long been regarded as the weak link in commercial computer systems. Even using the fast disc drives which are available to mainframe computers, more than 90 percent of the execution time of a program can be bound up with disc I/O. So for 90 percent of the time the program sits idle waiting for data.

A database management system or DBMS can be regarded as a software interface between the application program and a direct disc file. The job of the DBMS is to take information provided by the application program and turn that into a relative record number, indicating its exact location on the disc relative to the beginning of the file. The data can then be accessed more or less directly for processing. The non-DBMS alternative might be to search through a large part of

the file before the correct data is found.

The three most common access techniques used by many DBMSs are key-directed, key-indexed and access through pointer chaining. All involve the concept of a key, which is a unique or non-unique identifier that forms part of the record.

Key-directed access involves the designation of part of the record as a unique key. The application will give the DBMS a key value such as an inventory part number, and the disc area where that part's data is stored will be accessed. At its simplest the part number could be a relative record number, though keys often have their own intrinsic significance.

The key value is used as input to an algorithm that produces a valid relative record number for the file. This is an efficient method of reaching data as long as

the algorithm, the file size and the range of keys found combine to produce a good spread of different record numbers. Of course, this is not always the case and it is inevitable that some duplicate RRNs will occur.

Key-indexed access involves holding an index table together with the file. This table will contain a key/record-number pair for each record on the file and must be updated as records are added or removed. Knowing the file space available and the key length of the record, the DBMS can determine the maximum size of the index table and allocate the necessary space for it at the beginning of the file.

When a request is made to access data for a given key value the index records are read and scanned for a match. The corresponding record number may then be

```

10 ***** Program 1.
20 * 26-07-83 ver 1.0 *
30 * PROGRAM: ADDPTRS.BAS *
40 * READ FILE IN AND ADD 8 BYTES (initialized to all 'E') *
50 * BEFORE WRITING TO THE NEW OUTPUT FILE *
60 *****
70 CLS:KEY OFF
80 *-----**INDEX BUILDING SYSTEM SCR
EEN HEADER **
90 TL%=CHR$(201):BL%=CHR$(200):TR%=CHR$(187):BR%
=CHR$(188):VE%=CHR$(186):HO%=CHR$(205)
100 TITLE$(1)=TL%+HO%+HO%+TR%
110 TITLE$(2)=VE%+"PM"+VE%+ " INDEX BUILDING S
YSTEM "
120 TITLE$(3)=BL%+HO%+HO%+BR%
130 CLS:FOR CNT=1 TO 3:PRINT TAB((80-LEN(TITLE$(
2)))/2);TITLE$(CNT):NEXT CNT
140 PRINT :PRINT " ** File Copy Program **":P
RINT
150 *-----**GET INPUT FILE NAME AND R
ECORD LENGTH**
160 INPUT "ENTER INPUT FILENAME (DEF.=B:PFTESTA1
.DAT)",F.NAME$
170 IF F.NAME$="" THEN F.NAME$="B:PFTESTA1.DAT"
180 INPUT "ENTER RECORD LENGTH (DEF.=180).....
....",RECLEN$
190 IF RECLEN$="" THEN RECLEN=180 ELSE RECLEN=VA
L(RECLEN$)
200 IF RECLEN=0 THEN BEEP:GOTO 180
210 OPEN "R",#4,F.NAME$,RECLEN
220 IF LOF(4)=0 THEN PRINT "NULL FILE - PLEASE R
E-ENTER NAME":CLOSE #4:KILL F.NAME$:GOTO 160
230 FIELD #4,RECLEN AS REC$
240 LRECNUM=INT(LOF(4)/RECLEN) '**calc. last re
cord number**
250 RECNUM=0
260 *-----**GET OUTPUT FILE NAME **
270 PRINT:INPUT "ENTER OUTPUT FILENAME (DEF.=B:T
EST001.DAT)",F.ONAME$
280 IF F.ONAME$="" THEN F.ONAME$="B:TEST001.DAT"
290 OPEN "R",#5,F.ONAME$,RECLEN+8
300 FIELD #5,RECLEN AS RECOUT$, 8 AS PTRS$
310 IF LOF(5)>0 THEN PRINT "Warning** OUTPUT F
ILE ALREADY EXISTS":PRINT " - enter 'Y' to de
lete and continue, or 'N' to re-enter name" ELSE
GOTO 350
320 IK$=INKEY$:IF IK$="" THEN GOTO 320
330 IF IK$="Y" OR IK$="y" THEN CLOSE #5:KILL F.O
NAME$:GOTO 290
340 IF IK$="N" OR IK$="n" THEN CLOSE #5:GOTO 270
350 *-----**PROCESS DATA**
360 RECNUM=RECNUM+1
370 IF RECNUM>LRECNUM THEN GOTO 430
380 GET #4, RECNUM
390 A$=REC$
400 LSET RECOUT$=A$:LSET PTRS$=STRING$(8,"E")
**format output**
410 PUT #5,RECNUM
**write output **
420 GOTO 360
430 *-----**END OF PROCESSING**
440 CLOSE#4,#5
450 BEEP:PRINT :PRINT "file ";F.ONAME$;" created
successfully"
460 END
470 *-----**SAVE PROGRAM**
480 SAVE "B:TEMPSAVE.BAS"
490 KILL "B:ADDPTRS.BAS"
500 NAME "B:TEMPSAVE.BAS" AS "B:ADDPTRS.BAS"
510 BEEP:PRINT "B:ADDPTRS.BAS saved"

```

used by the DBMS to get the appropriate data.

To reduce I/O requirements it is often desirable to keep an index in main memory after it has first been accessed, enabling file handling to be almost as efficient as in key-directed access. But for big files, and where several files are being processed concurrently, limited memory size may prevent this.

Pointer chaining is often combined with the methods already described. Chaining is a means of joining related data, such as a group of records within a file, by embedding in each record a pointer which is the RRN of the next record in the group. In an order file, where the natural key would be the order number, all the orders for a particular item could be chained together. Each order would have a pointer to the next record in the file referencing the same item, or possibly to a blank pointer if there were no more references.

For maintenance purposes there must be a pointer to the previous record in a chain; otherwise, there would be no way of removing the chain reference to a deleted record from its predecessor. Pointers can also point across file boundaries. Provided the DBMS knows, there is no reason why item records in the inventory parts file should not each have a pointer giving the RRN of the first record in its related order-file chain.

Complex paths

Pointer chaining can provide quite complicated access paths through a database. The drawback is a considerable overhead in the complexity of file maintenance and of the physical I/O involved to get and update pointers in the related records as new data is added or old data deleted.

In the key-directed method, pointer

chaining is commonly used to overcome problems with synonyms. A synonym occurs if the algorithm produces the same record number for two different key values. In this case, when a synonym first occurs the data may be placed in the nearest free record number to that produced by the algorithm. The idea is that it may possibly exist in the same buffer as the original record and so not require physical I/O to access it.

The first record is updated with a synonym chain pointer giving the position of the new record. A third synonym would then be added at the end of the chain close to the second record.

Indexing may readily be combined with chaining for non-unique keys so that each index value effectively points to a group of related records. This is the type of implementation used by the Basic programs in this article. Chaining can also occur at the index level, as happens in a particularly neat way in the file-management system used by MS-DOS.

To MS-DOS a disc is similar to the direct file in the example in that it is divided into a fixed number of fixed-length allocation units or AUs, which are analogous to records. The first few units contain index data for two types of index. The first, called the directory, contains an entry for every file on the disc, each with a key of file name, an AU number of the first unit belonging to the file and some additional data.

(continued on next page)

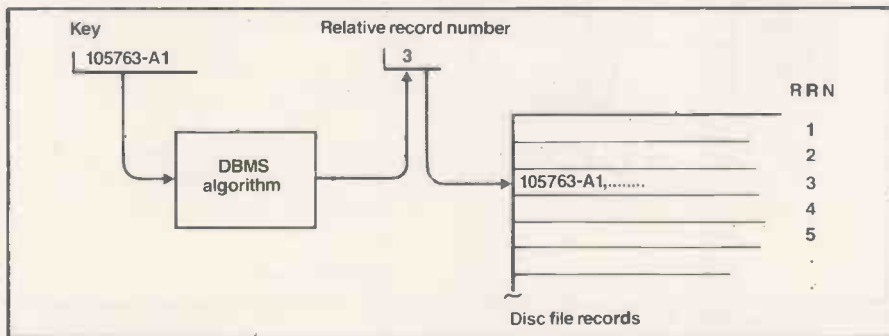

Key-directed access.

```

10 *****
20 * 19/07/83 ver. 1.1 *
30 * INDEX BUILDING SYSTEM - program: PFINXCR1.BAS *
40 * ** INDEX BUILDER ** *
50 * Program accepts - input filename, record length *
60 * - date field start posn. (dd/mm/yy) *
70 * - 2nd index field start posn. & length *
80 * Program updates - input file records with 2 pointer chain *
90 * one associated with date, the second with the other index *
100 * value; both having a forward and a backward reference *
110 * Program creates - 2 index files 'filename.IN1' and *
120 * 'filename.IN2' which are tables associating an index value *
130 * with a first and a last record nr. in a file chain *
140 *****
150 KEY OFF
160 *-** INDEX BUILDING SYSTEM SCREEN HEADER **
170 TL%=CHR$(201):BL%=CHR$(200):TR%=CHR$(187):BR
   %=CHR$(188):VE%=CHR$(186):HO%=CHR$(205)
180 TITLE$(1)=TL%+HO%+HO%+TR%
190 TITLE$(2)=VE%+"PM"+VE%+" INDEX BUILDING S
   YSTEM "
200 TITLE$(3)=BL%+HO%+HO%+BR%
210 CLS:FOR CNT=1 TO 3:PRINT TAB((80-LEN(TITLE$(
   2)))/2);TITLE$(CNT):NEXT CNT
220 PRINT :PRINT " ** index building program
   **":PRINT
230 *-----** GET FILE NAME & RECORD LENGTH **
240 LOCATE 10,1:PRINT SPACE$(79):LOCATE 10,1:INP
   UT "Enter filename (default=B:TEST001.DAT) ",F.N
   AME$
250 IF F.NAME$="" THEN F.NAME$="B:TEST001.DAT"
260 LOCATE 11,6:PRINT SPACE$(73):LOCATE 11,6:INP
   UT "Enter record length (default=188) ",RECLEN$
270 IF RECLEN$="" THEN RECLEN=188 ELSE RECLEN=VA
   L(RECLEN$)
280 IF RECLEN<9 THEN BEEP:GOTO 260
290 OPEN "R",#4,F.NAME$,RECLEN
300 FIELD #4,RECLEN AS REC$
310 FIELD #4,RECLEN-8 AS DATAIN$,2 AS DATFWD$,2
   AS DATBWD$,2 AS INXFWD$,2 AS INXBWD$
320 **Test for >0 file length **
330 IF LOF(4)=0 THEN CLOSE #4:KILL F.NAME$:LOCAT
   E 22,1:PRINT "FILE NAME INVALID PLEASE RE-ENTER"
   ;:GOTO 240
340 LOCATE 22,1:PRINT SPACE$(79);
350 *-----** GET POSITION OF DATE & VALIDATE **
360 LOCATE 13,1:PRINT SPACE$(79):LOCATE 13,1:INP
   UT "Enter start position of date field (default=
   1) ", DATPOS$
370 IF DATPOS$="" THEN DATPOS=1 ELSE DATPOS=VAL(
   DATPOS$)
380 IF DATPOS<1 OR DATPOS>(RECLEN-8) THEN GOTO 4
   30
390 GET #4,1 **check value in file is a date**
400 RDAT$=MID$(REC$,DATPOS,8)
410 YY%=RIGHT$(RDAT$,2):MM%=MID$(RDAT$,4,2):DD%=
   LEFT$(RDAT$,2)
420 IF VAL(YY%)<81 OR VAL(YY%)>85 OR VAL(MM%)<1
   OR VAL(MM%)>12 OR VAL(DD%)<1 OR VAL(DD%)>31 THEN
   GOTO 430 ELSE GOTO 440
430 LOCATE 22,1:PRINT "NOT A VALID DATE POSITION
   - PLEASE RE-ENTER";:LOCATE 12,1:GOTO 360
440 LOCATE 22,1:PRINT SPACE$(79);
450 LOCATE 17,1:PRINT SPACE$(79);:

```

Program 2.

(listing continued on next page)

(continued from previous page)

The second index or file-allocation table, FAT, has an entry for every allocation unit on the disc. Here the key is Current AU, which is implied by its position in the table, and the referenced value is Next AU. The directory acts as a conventional index to both data, by pointing to the first AU in the file, and to the FAT by pointing to the start of the index chain for that file. The FAT acts as index, by pointing to the next AU of data in the file, and as a chain pointer by pointing to the next element in the FAT for the file. End of chain in the FAT is indicated by a pointer value of -1.

One at a time

This method of management enables DOS to give one allocation unit at a time to a file as and when it is needed, avoiding the necessity to allocate one contiguous full-sized block of space when a file is first used, which subsequently could only be extended by using a special utility program.

When I was feeling my way around the IBM PC, one of the first applications I wrote was a personal finance system. It allowed me to register all my expenditure and to produce reports summarising the data by month, or by group such as Food or Business, or by a numeric account code which I allocated to each transaction. An on-line enquiry program allowed me to scan down the file searching on date, or

group, or account code. I often use it to check what has recently been added to the file to make sure that nothing has been input twice or missed out altogether.

The system worked well enough while the file was small, but waiting for the program to search through five or six months data became a serious tax on my patience. The solution I chose was to reorganise the data into indexes and chains.

My most frequent enquiry was by date — not necessarily a specific date, more of the nature "What did I enter for expenditure the weekend before last?" The second most used enquiry was for group. For the purpose of dipping into the file by data, if I bundled the data roughly into weeks,

searching by date should be relatively efficient and the index would remain reasonably small. About 20 different group values were assigned to the data so that field could easily be used as a compact index.

The system takes any MS-DOS random file as input. Through a series of prompts it obtains information about the record length of the input file and the relative positions of a date field and another field to be used in accessing the file. Two index files are created, each containing a one-record table of key/record-number pairs. The input file is copied as a new Data file with records eight bytes longer than the original.

(continued on page 55)

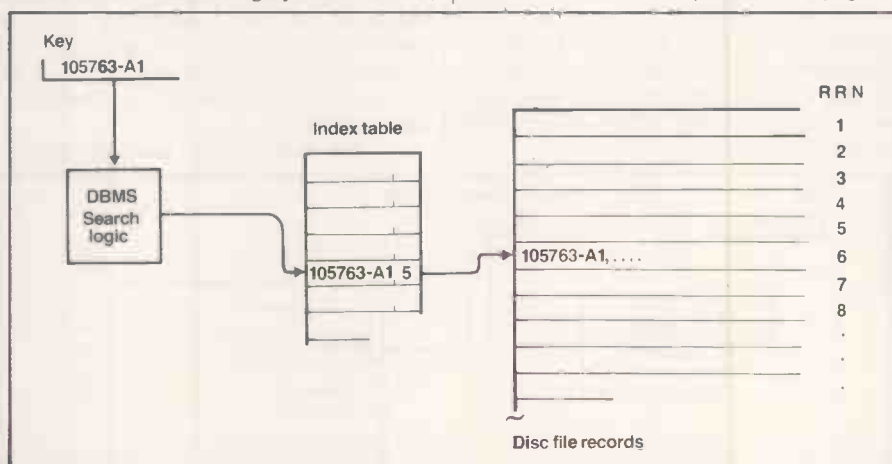

Key-indexed access.

(listing continued from previous page)

```

460 '-----** GET POSN. & LENGTH OF 2ND INDEX **
470 LOCATE 15,1:PRINT SPACE$(79):LOCATE 16,1:PR
NT SPACE$(79):LOCATE 15,1
480 INPUT "Enter index field start position ", I
N2POS$
490 INPUT "          length ", I
N2LEN$
500 IN2POS=VAL(IN2POS$):IN2LEN=VAL(IN2LEN$)
510 IF IN2POS=999 THEN IN2FLAG=1 ELSE IN2FLAG=0
520 IF IN2POS<1 OR IN2POS>(RECLN-IN2LEN) THEN G
OTO 600
530 IF IN2LEN<1 OR IN2LEN>12 THEN GOTO 600
540 IN2VAL$=MID$(REC$,IN2POS,IN2LEN)
550 PRINT "The first value on file is ";IN2VAL$
;" is this correct (enter y/n) "
560 IK$=INKEY$:IF IK$="" THEN GOTO 560
570 IF IK$="N" OR IK$="n" THEN GOTO 450
580 IF IK$="Y" OR IK$="y" THEN GOTO 610
590 BEEP:GOTO 560
600 LOCATE 22,1:PRINT "VALUES INPUT ARE NOT VALI
D - PLEASE REENTER":LOCATE 15,1:GOTO 450
610 LOCATE 22,1:PRINT SPACE$(79);
620 '-----** INITIALIZE TABLES **
630 DIM TDAT!(50),TDAT1%(50),TDAT2%(50)
640 TDAT!(1)=0:TDAT!(2)=830100!:TDAT!(50)=999999
!
650 FOR I=3 TO 5:TDAT!(I)=TDAT!(I-1)+8:NEXT
660 FOR I=6 TO 49:TDAT!(I)=TDAT!(I-4)+100:NEXT
670 DIM IN2VAL$(20),IN21%(20),IN22%(20):IN2ELS=0

680 '-----** PROCESS INPUT **
690 LRECNM=INT(LOF(4)/RECLN)
700 RECNUM=0:CUR=1:IN2ELS=0
710 RECNUM=RECNUM+1
720 IF RECNUM>LRECNM THEN GOTO 1170 '**END OF F
ILE**
730 GET #4,RECNUM
740 STORREC$=REC$ '**Store record for later upda
te**
750 CDATFWD=0:CDATBWD=0:CINXFWD=0:CINXBWD=0 '**I
nitialize current records pointers **
760 GOSUB 980 '**GET AND FORMAT INDEX VALUES IN

```

```

'RECDAT' AND 'RECVAL$' **
770 '-----** PROCESS DATE **
780 IF RECDAT!<TDAT!(CUR) THEN CUR=CUR-1:GOTO 78
0
790 IF RECDAT!>TDAT!(CUR+1) THEN CUR=CUR+1:GOTO
790
800 GOSUB 1030 '**UPDATE DATE POINTERS*
*
810 '-----** PROCESS 2ND INDEX **
820 NOMATCH=1:SUB=0
830 WHILE NOMATCH
840 SUB=SUB+1
850 IF SUB>20 THEN PRINT "IN2VAL TABLE OVERFLOW"
:NOMATCH=0:STOP
860 IF SUB>IN2ELS THEN IN2VAL$(SUB)=RECVAL$:IN2E
LS=SUB:NOMATCH=0
870 IF RECVAL$=IN2VAL$(SUB) THEN NOMATCH=0
880 WEND
890 IF RECVAL$<>IN2VAL$(SUB) THEN IN2VAL$(SUB)=R
ECVAL$:IN2ELS=SUB
900 GOSUB 1100 '**UPDATE 2ND INDEX POIN
TERS**
910 '-----** UPDATE CURRENT RECORD **
920 LSET REC$=STORREC$ '**Restore saved input da
ta**
930 LSET DATFWD$=MKI$(CDATFWD):LSET DATBWD$=MKI$
(CDATBWD)
940 LSET INXFWD$=MKI$(CINXFWD):LSET INXBWD$=MKI$
(CINXBWD)
950 PUT #4,RECNUM
960 GOTO 710
970 END
980 '-----** SUB-ROUTINE : UNP
ACK DATA FROM INPUT RECORD AND REFORMAT DATE **
990 RDAT$=LEFT$(STORREC$,8)
1000 RECDAT!=VAL(RIGHT$(RDAT$,2)+MID$(RDAT$,4,2)
+LEFT$(RDAT$,2))
1010 RECVAL$=MID$(STORREC$,IN2POS,IN2LEN)
1020 RETURN
1030 '-----** SUB-ROUTINE : UPD
ATE DATE POINTERS **
1040 IF TDAT1%(CUR)>0 THEN GOTO 1060

```

(listing continued on page 55)

HOW TO IMPROVE YOUR IBM PC AND XT

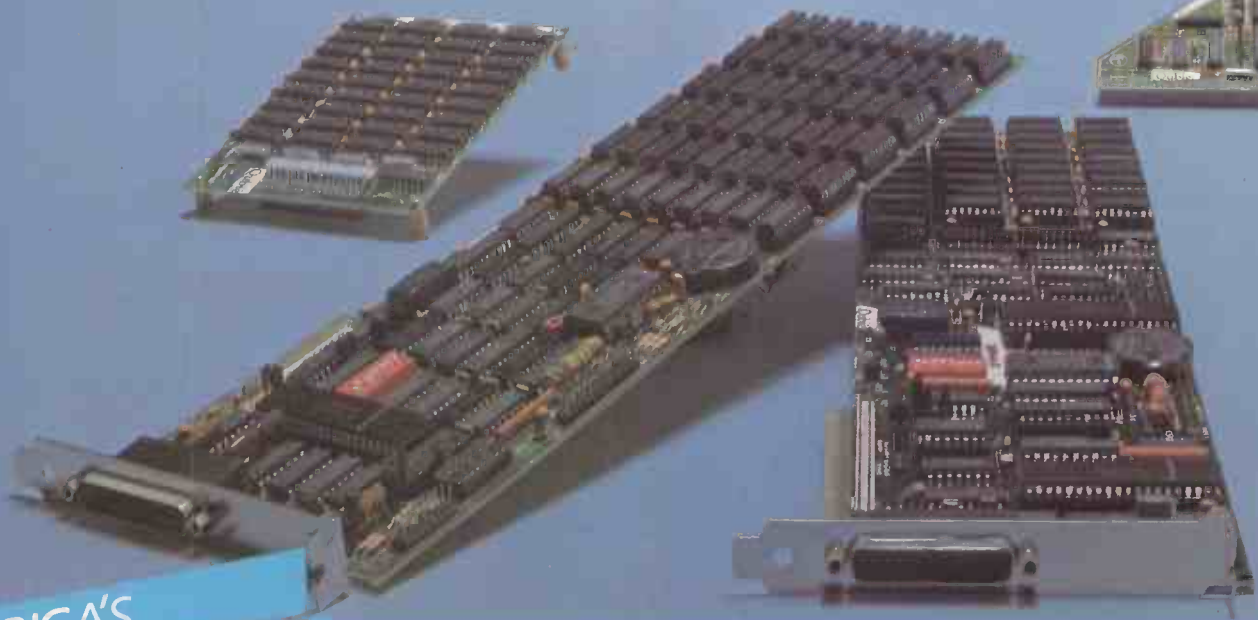
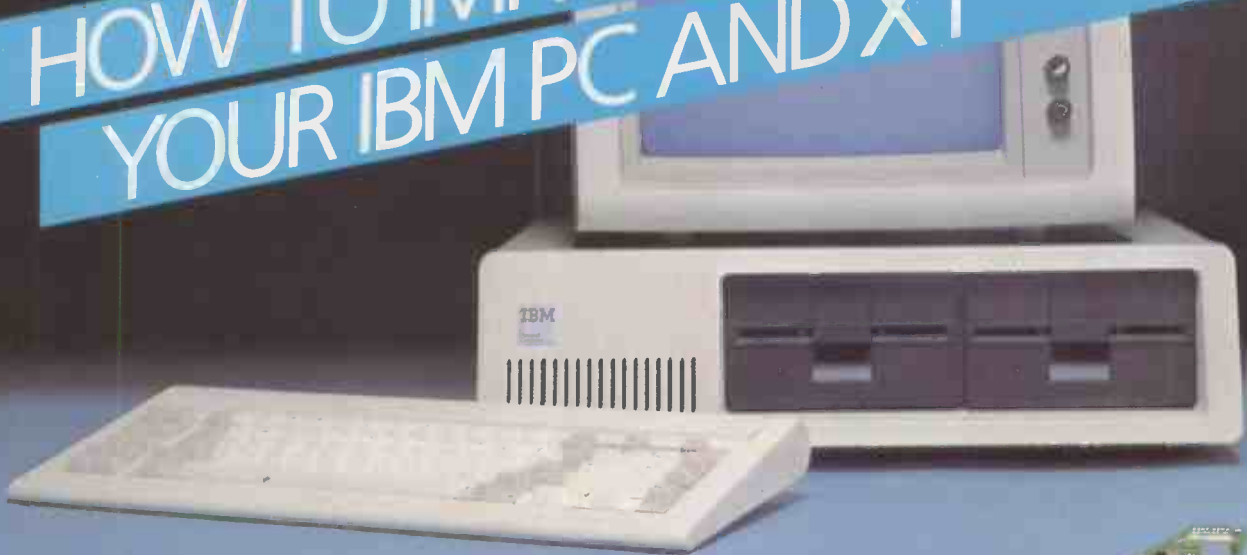

AMERICA'S MOST POPULAR ENHANCEMENTS FOR IBM PC AND XT

MAKE YOUR COMPUTER WORK HARDER FOR YOU

If you have purchased the IBM PC or XT then you are the owner of a very fine computer.

But like everything else it can be improved to work harder for you. It took a company like Qubie' to do it.

Qubie' can supply either the SixShooter or the Q Plus II to up-grade your IBM PC or XT. Both are engineered to match the IBM quality stamp.

While only occupying one slot in your computer these

two boards boost your PC or XT's capability with a selection of essential features.

SIXSHOOTER - IDEAL FOR PC OR XT

For most customers the SixShooter offers all that you require from a multifunction board. 64K or Ram (socketed up to 384K), a serial port, a parallel port, automatic clock/calendar with battery back up are all standard. An IBM compatible games port adaptor is optional.

Q PLUS II - MORE OPTIONS

Corporate customers and those with special needs will appreciate the ability of the Q plus II. Ram is expandable from 64K all the way to 512K. Add two serial ports, a parallel port clock/calendar and a games port to give 4 I/O connections from one slot.

IBM is the registered trademark of International Business Machines.

QUBIE' PAK SOFTWARE SPEEDS THINGS UP

Free with each board are the custom-made Qubie' drive™ and Qubie' spool™ programmes.

Qubie' drive™ disk emulation software allows you to create up to three "electronic disk drives" in memory which access your programmes at the speed of RAM memory.

Qubie' spool™ is a

programme which allows you to assign a portion of memory to act as a print spooler.

QUALITY BACKED BY WARRANTY

Both boards are backed by our one year parts and labour warranty.

Visit your local dealer and pick up a brochure with the full details. If he does not have the information contact us.

It's the best way to improve your PC.

QUBIE'

DISTRIBUTING LTD.

QUBIE' - IMPROVING WHERE OTHERS STOP.

Qubie' Distributing Ltd.
Tempo House, 15 Falcon Road,
London SW11.
(01) 223-4569/7662.
Telex: 8956035. G.

Qubie' Distributing Ltd.
4809 Calle Alto, Camarillo,
CA 93010, USA.
805-987-9741.

● Circle No. 135



PULSAR BLUE

Heaven sent for IBM users.

Pulsar, the 16-bit business software which became a best seller on the Sirius 1 microcomputer is now available for IBM PC users. Already over 10,000 Pulsar systems have been sold, bringing the benefits of true 16-bit computing to multinational companies, small businesses and institutions throughout the UK.

Pulsar Blue is an integrated range of commercial accounting, office systems, planning and modelling software from ACT bringing a new dimension to personal computing. Pulsar Blue is powerful, but friendly. Help routines, concise documentation and simple menus built in to the programs ensure that first time users can quickly familiarise themselves with even the most sophisticated systems. This combination of user friendliness and powerful processing has made Pulsar the most successful 16-bit business software in the country. And its available from IBM dealers now.

Pulsar Blue – a gift from heaven for IBM users.



The Pulsar Blue Range			
Sales Ledger	£195	d Graph™	£195
Purchase Ledger	£195	MicroModeller™	£595
Nominal Ledger	£195	Mars™	£395
Payroll	£195	SuperCalc 2™	£195
Stock Control	£195	SuperCalc 3™	£295
Invoicing	£195	(graphics spreadsheet)	
Data Analysis	£195	Multiplan™	£195
Informer Database	£295	Wordstar™	£295
d Base II™	£395	MailMerge™	£95
		SuperWriter™	£295



For more information on Pulsar Blue for the IBM PC clip the coupon and return to

ACT (Pulsar) Ltd
 Freepost
 Birmingham B16 1BR
 or call 021-455 7000

Please send me details of Pulsar Blue – business software for the IBM user.

Please state make of Micro currently used _____

Name _____

Position _____

Company _____

Address _____

Tel _____

● Circle No. 136
 PCMAY/84

™ indicates registered trade mark. Ownership details on request. All prices exclude VAT.

A SELECTION FROM OUR PRODUCT RANGE

High Level Languages

ADA	Supersoft
BASIC INTERPRETER	Microsoft
BASIC COMPILER	Supersoft
BASIC COMPILER V5.3	Microsoft
BUSINESS BASIC COMPILER	Microsoft
C COMPILER	Microsoft
C COMPILER	Supersoft
CBASIC	Digital Research
CBASIC COMPILER	Digital Research
CIS COBOL	Micro Focus
COBOL COMPILER	Microsoft
FORTH	Supersoft
FORTRAN	Supersoft
FORTRAN COMPILER	Microsoft
LEVEL-2 COBOL	Micro Focus
LISP	Supersoft
muLISP	Supersoft
muMATH/muSIMP	Microsoft
PASCAL COMPILER	Microsoft
PASCAL MT+	Digital Research
PL/1	Digital Research

Low Level Languages

MACRO-80	Microsoft
PROGRAMMERS UTILS (RASM)	Digital Research

Program Development Tools

ANIMATOR	Micro Focus
BUG	Phoenix Software
DISPLAY MANAGER	Digital Research
FTNUMB	Micrology
LEVEL II ANIMATOR	Micro Focus
POEVELOP	Phoenix
PLINK II	Phoenix
PLINK-86	Phoenix
SIO	Digital Research
SPEED PROGRAMMING PACKAGE	Digital Research
XLT-86	Digital Research
ZSID	Digital Research

Utilities/System Tools

CLIP	Keele Codes
DESPool	Digital Research
DIAGNOSTICS II	Supersoft
DISK DOCTOR	Supersoft
DISKED-2	Slogger Software
DISK-EDIT	Supersoft
DISKMAN	Slogger Software
DISKORG	Slogger Software
DISKTOOLS-1 (DISKMAN & DISKORG)	Slogger Software
DISKTOOLS-2 (DISKTOOLS-1 & DISKED-2)	Slogger Software
DUTIL (FOR DBASE-II)	Fox & Geller
FILESHARE	Micro Focus
DEC RAINBOW SERVICE S/W: (1) Format/Verify Service (2) Autorun Service (3) Function Key Service SERVICE S/W VOL. 1 (1, 2 & 3)	Silicon Valley Corp.
SYSTEM CHECKER	Supersoft
THE OPERATING GUIDE	Decision Systems
UTILITIES I	Supersoft
UTILITIES II	Supersoft

Sorting

MSORT	Microsoft
SUPERSORT	Micropro

Code Generators

AUTOCODE	Stemmos
FORMS-2	Micro Focus
QUICKCODE	Fox & Geller
SOURCEWRITER	Softwright
THE LAST ONE	O.J. 'A1' Systems
THE LAST ONE—COMPACT	O.J. 'A1' Systems

Telecommunications/Conversions

BACDEBIT	Comley
BACSCOPY	Comley
BSTAM	Byrom Software
BSTMS	Byrom Software

	CP/M	CP/M-86	MS-DOS	PC-DOS	Telecommunications Cont.	CP/M	CP/M-86	MS-DOS	PC-DOS
ICL CO3 EMULATION (Bulk)	Synchro Systems
ICL CO3 EMULATION (Interactive)	Synchro Systems
ICL CO3 EMULATION (Interactive & Bulk)	Synchro Systems
REFORMATTER CP/M ↔ DEC	Microtech Exports
REFORMATTER CP/M ↔ IBM	Microtech Exports

Word Processing/Text Editing/Editors

CORRECTOR	Supersoft
EDIT-80 V2.02	Microsoft
FRIDAY	Ashlon Tate
MAILMERGE	Micropro
MEMOPLAN	Chang Labs
WORD	Microsoft
WORD WITH MOUSE	Microsoft
PARAGRAB	Focus
PEOIT	Phoenix
PMATE	Phoenix
SPELLSTAR	Micropro
STARBURST	Micropro
STARINDEX	Micropro
WORDMASTER	Micropro
WORDSTAR	Micropro
WORDSTAR PROFESSIONAL (WS+MM+SS+STAR INDEX)	Micropro

Databases/Data Management Systems

DATASTAR	Micropro
DBASE-II	Ashlon Tate
INFOSTAR	Micropro
REPORTSTAR	Micropro

Financial Accounting

INCOMPLETE RECORDS SYSTEM	MPI
NOMINAL LEDGER	Padmede
OPEN ITEM PURCHASE LEDGER	Padmede
OPEN ITEM SALES LEDGER	Padmede
PADMEDE BUSINESS CONTROL SYSTEM	Padmede
PAYROLL	MPI
PURCHASE LEDGER	Padmede
SALES INVOICING	Padmede
SALES LEDGER	Padmede
TIME & COST RECORDING	Padmede

Financial Modelling/Problem Solving

CALCSTAR	Micropro
DECISION ANALYST	Executive Software
LINEAR & GOAL PROGRAMMING	EAS
MATHSPACK	MPI
MICROPLAN	Chang Labs
MULTIPLAN	Microsoft
PLANTRAC 1	Computerline
PLANTRAC 1 - PROFIT PLAN	Computerline
QSTAT	Chang Labs
STATSPACK	Pivotal Software
TKI SOLVER	MPI
TKI SOLVER PACKS	Software Arts
FINANCIAL MANAGEMENT	
MECH ENGINEERING	

Business Applications

JOB COSTING	Heseltine
POLICY MASTER	CSA Micro Systems
PRINT ESTIMATION	Software Mgmt Systems
STOCK CONTROL	Padmede

Training Aids

CP/M TUTOR	Syntax Software
KEYBOARD MASTER	Anthony Ashpitel
TYPING MASTER	Anthony Ashpitel

Graphics

dGRAPH	Fox & Geller
STATGRAPH	Supersoft

PLINK

86

THE TRUE LINKAGE EDITOR

An overlay linkage editor that can bind together individually compiled modules of a programme into one or more files, that may be loaded and executed by the operating system.

* An interactive or batch-link leader

* Works on CP/M-86, PC-DOS and MS-DOS, and fully supports the MS-DOS2 Directory Tree Structure.

* Is a true 16-bit overlay linker.

* Can create MS-DOS programmes under CP/M86 and then pull these programmes across.

* Under MS-DOS, Plink-86 can be used with the following languages:

MICROSOFT LATTICE C
FORTRAN
PASCAL
BASIC
COBOL
ASSEMBLER

* Under CP/M86, Plink-86 can be used with LATTICE C.

* Input to Plink-86 can be free-format and multi-line.

ORDER INFORMATION

When ordering software please specify the format you require. All software items are subject to VAT Manuals, when purchased separately, are not subject to VAT. Please add £3.75 (plus VAT) for postage and packing for the first item purchased, and then £2.00 for each extra item. For overseas please add £6.50 for the first item and then £2.15 for each extra item required. Most software in this advertisement is available from stock. These details are current as of January 1984 (Telephone at time of purchase to confirm latest prices.) All payments must be in Sterling and drawn against a U.K. bank. Prices may change without notice due to fluctuations in the dollar exchange rate. Please confirm price at time of ordering.



* Free Catalogue Available

* Retailer and OEM Terms Available



Microcomputer Products International Limited

Room PC5,
Central House,
Cambridge Road,
Barking,
Essex IG11 8NT.

Tel: 01-591-6511
Telex: 892395

● Circle No. 137

(continued from page 50)

The process uses three programs. The first converts an existing random file by adding eight bytes on to every record before writing it out to a new file. The second program prompts for the position of a date, and for a second key field and its length in the input file. It then takes the converted file and builds two index tables based on predetermined date ranges and, for the second index, on values found on the input file.

The tables are written out as two separate files, while the input file is updated with pointer chains related to the index values. The third program is a skeleton for inclusion in an enquiry process and may be used to test the successful implementation of the indexed chains. All the programs are written in IBM Basic to run under MS-DOS.

The program called AddPtrs prompts for the name and record length of the input file. Having determined that this exists it requests the name to be used for a new output file. If a file with such a name exists you are given the option to delete the existing file and continue, or to re-enter a different output file name.

The output file will contain the same data as input but the records will be eight bytes longer, allowing space for four pointers. These eight bytes are added to the end of each record and are initialised to all £s, so the successful formatting of the output file should be easy to recognise.

All the programs have default values for responses which can easily be changed in the code. Here the default input file is B:PFTESTA1.DAT, with a record length

RRN	Order no.	Item no.	Pointers fwd	bwd
1	1010	100	3	0
2	1020	032		
3	1030	100	8	1
4	1040	271		
5	1050	102		
6	1052	108		
7	1060	057		
8		100		3
9		100		0
10				8

A pointer chain.

of 180 bytes. The output file name defaults to B:TEST001.DAT.

The second program, PfInxCRI, prompts for the input file name and record length. If the file exists it then prompts for the position of the date field, which should be in the format

dd*mm*yy

where * may be any character. The input value is checked by accessing the first record on file.

If a date is found in the position indicated the second index position and length is prompted. A maximum length of 12 characters is allowed for: this may be altered, but the limiting factor is the output file field size of 256 characters. The value

(continued on next page)

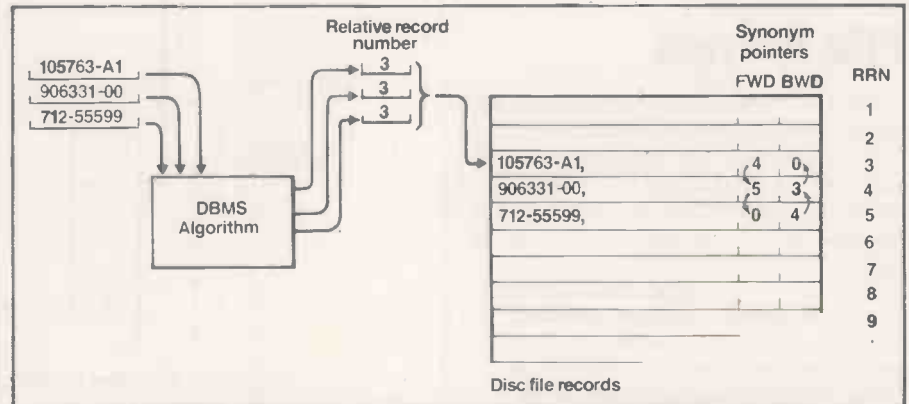

A pointer chain can overcome problems with synonyms in key-directed access.

(listing continued from page 50)

```

1050 TDAT1%(CUR)=RECNUM:TDAT2%(CUR)=RECNUM:CDATF
WD=0:CDATBWD=0:GOTO 1090
1060 GET #4,TDAT2%(CUR)
1070 LSET DATFWD$=MKI$(RECNUM):PUT #4,TDAT2%(CUR)
  **UPDATE FWD PTR ON PREVIOUS LAST RECORD**
1080 CDATFWD=0:CDATBWD=TDAT2%(CUR):TDAT2%(CUR)=R
ECNUM
1090 RETURN
1100 -----** SUB-ROUTINE : UPD
ATE INDX POINTERS **
1110 IF IN21%(SUB)>0 THEN GOTO 1130
1120 IN21%(SUB)=RECNUM:IN22%(SUB)=RECNUM:CINXFWD
=0:CINXBWD=0:GOTO 1160
1130 GET #4,IN22%(SUB)
1140 LSET INXFWD$=MKI$(RECNUM):PUT #4,IN22%(SUB)
  **UPDATE FWD PTR ON PREVIOUS LAST RECORD**
1150 CINXFWD=0:CINXBWD=IN22%(SUB):IN22%(SUB)=REC
NUM
1160 RETURN
1170 -----** CREATE INDEX FILES **
1180 CLOSE #4
1190 EXT$=RIGHT$(F.NAME$,4) **remove extension
from filename**
1200 IF LEFT$(EXT$,1)=". " THEN I.NAME$=LEFT$(F.N
AME$,LEN(F.NAME$)-4) ELSE I.NAME$=F.NAME$
1210 I1.NAME$=I.NAME$+".I1":I2.NAME$=I.NAME$+".
IN2"
1220 LOCATE 18,1
1230 OPEN "R",#4,I2.NAME$,20*(IN2LEN+2) -----
**2ND INDEX FILE**
1240 IF LOF(4)=0 THEN GOTO 1300
1250 PRINT "file ";I2.NAME$;" already exists - 0
K to overwrite? (type Y or N)"
1260 IK$=INKEY$:IF IK$="" THEN GOTO 1260
1270 IF IK$="Y" OR IK$="y" THEN CLOSE #4:KILL I2
.NAME$:GOTO 1230
1280 IF IK$="N" OR IK$="n" THEN CLOSE #4:INPUT "
ENTER ALTERNATIVE NAME FOR DATE INDEX FILE ",I1.
NAME$:GOTO 1230
1290 BEEP:GOTO 1260 **invalid response**
1300 FIELD #4,20*IN2LEN AS IN2TAB$,20*2 AS IFWDT
AB$, 20*2 AS IBWDTAB$

```

```

1310 TABLE$="" :FOR I=1 TO 20:TABLE$=TABLE$+(IN2V
AL$(I)):NEXT
1320 LSET IN2TAB$=TABLE$
1330 TABLE$="" :FOR I=1 TO 20:TABLE$=TABLE$+MKI$(
IN21%(I)):NEXT
1340 LSET IFWDTAB$=TABLE$
1350 TABLE$="" :FOR I=1 TO 20:TABLE$=TABLE$+MKI$(
IN22%(I)):NEXT
1360 LSET IBWDTAB$=TABLE$
1370 PUT #4,1
1380 CLOSE #4
1390 OPEN "R",#4,I1.NAME$,36+51*(4+2+2) -----
**DATE INDEX FILE**
1400 IF LOF(4)=0 THEN GOTO 1460
1410 PRINT "file ";I1.NAME$;" already exists - 0
K to overwrite? (type Y or N)"
1420 IK$=INKEY$:IF IK$="" THEN GOTO 1420
1430 IF IK$="Y" OR IK$="y" THEN CLOSE #4:KILL I1
.NAME$:GOTO 1390
1440 IF IK$="N" OR IK$="n" THEN CLOSE #4:INPUT "
ENTER ALTERNATIVE NAME FOR DATE INDEX FILE ",I1.
NAME$:GOTO 1390
1450 BEEP:GOTO 1420 **invalid response**
1460 FIELD #4,14 AS S.FILE$,2 AS S.RLEN$, 2 AS D
PSN$,14 AS I2.FILE$,2 AS IN2PSN$,2 AS IN2LN$,51*
4 AS DATTAB$,51*2 AS FWDTAB$, 51*2 AS BWDTAB$
1470 ** STORE TABLE DATA **
1480 TABLE$="" :FOR I=0 TO 50:TABLE$=TABLE$+MKI$(
TDAT!(I)):NEXT
1490 LSET DATTAB$=TABLE$
1500 TABLE$="" :FOR I=0 TO 50:TABLE$=TABLE$+MKI$(
TDAT1%(I)):NEXT
1510 LSET FWDTAB$=TABLE$
1520 TABLE$="" :FOR I=0 TO 50:TABLE$=TABLE$+MKI$(
TDAT2%(I)):NEXT
1530 LSET BWDTAB$=TABLE$
1540 ** STORE INPUT FILENAME, DATE POSN, INDEX
2 POSN & LENGTH **
1550 LSET S.FILE$=F.NAME$:LSET DPSN$=MKI$(DATPOS
):LSET IN2PSN$=MKI$(IN2POS)
1560 LSET IN2LN$=MKI$(IN2LEN):LSET S.RLEN$=MKI$(
RECLEN):LSET I2.FILE$=I2.NAME$

```

(listing continued on next page)

(continued from previous page)

found on the first record in the file is displayed for verification.

The date index table is initialised such that the first date is set to 000000 and the last to 999999. Intermediate values are in sequence and of the form 83mmdd, where mm varies from 01 to 12, and dd has values 00, 08, 16 and 24. Corresponding tables are allocated for a First pointer and a Last pointer. A similar set of tables is allocated for the second index, but is not initialised as values are obtained from the input data.

The input file is processed one record at a time. During this essentially sequential process other records may be read randomly and updated with new pointer values. The logic of this process is most easily understood from the code itself.

File names

When all records have been processed the program writes out the index files. The names are obtained by using the input file name with the extensions IN1 and IN2. If either file already exists, an opportunity is provided for you to input an alternative name.

The size of the second index table may vary from session to session according to the prompt responses. However, the date index table size is always fixed and so its file contains the information entered by the user. This includes input file name and

record length, index positions and length, and the second index file name. Thus program 3, or any other accessing program, need only be supplied with the date index file name for operation to be possible.

The index tables interact with the file and its pointer chains. While the second index points to records with exact corresponding values in the file, the date index has an implied range of values associated with it: dates that are not lower than the current index value, but are lower than the next value. All dates earlier than 1983, which when reformatted give a value less than

830100, will be chained to index 000000; similarly, all dates after 1983, which when reformatted give a value not less than 831224 but less than 999999, will be chained to index 831224.

Program InxLoad provides code to load the index tables; part of it is suitable for copying into an enquiry program. As it stands the program will provide visual verification that the index-creation process has been successfully carried out. To allow the output to be echoed to the printer hit Ctrl-PrtSc before program execution.

The user is prompted for the date index file name. All other data necessary for

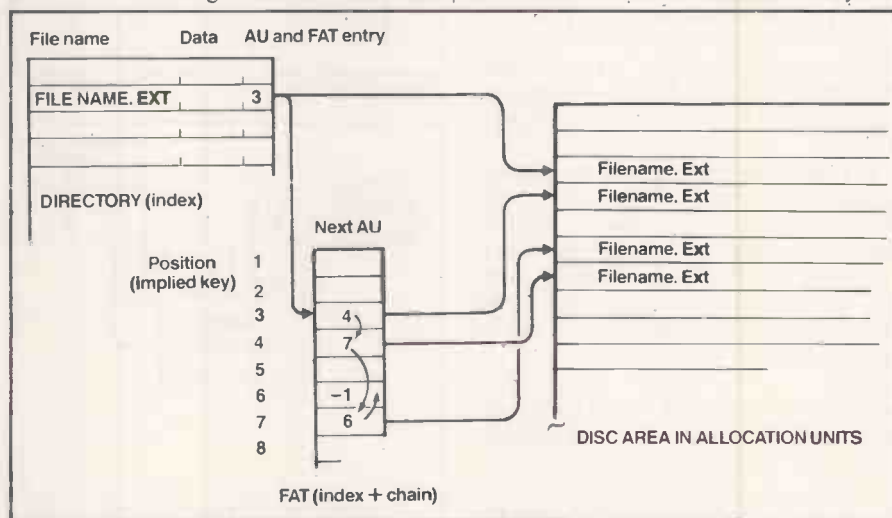

MS-DOS combines indexing and chaining techniques in its file-management system.

(listing continued from previous page)

```

1570 PUT #4,1
1580 CLOSE #4
1590 '-----** TERMINATION STATS **
1600 PRINT
1610 PRINT "New index files created for ";F.NAME
    $;" are ";I1.NAME$;" and ";I2.NAME$
1620 PRINT "##PROGRAM TERMINATED SUCCESSFULLY##"
1630 END
1640 '-----** SAVE PROGRAM **
1650 SAVE "B:TEMPSAVE.BAS"
1660 KILL "B:PFINXCR1.BAS"
1670 NAME "B:TEMPSAVE.BAS" AS "B:PFINXCR1.BAS"
1680 BEEP:PRINT "B:PFINXCR1.BAS saved"
1690 END

```

```

10 *****
20 ** 26-07-83 ver. 1.0.
30 ** INDEX BUILDING SYSTEM - program: INXLOAD.BAS **
40 ** Program accepts - filename for date index **
50 ** - filename & key length for 2nd index **
60 ** - main input filename & record length **
70 ** processing - creates index tables from index **
80 ** files and reads forward down all chains **
90 ** referenced by the date index table, then those **
100 ** referenced by the 2nd index table printing on **
110 ** the screen each index reference, the first 8 **
120 ** bytes of each record read, and the length of **
130 ** each chain. **
140 *****
160 **PM INDEX BUILDING SYSTEM SCREEN HEADER**
170 TL$=CHR$(201):BL$=CHR$(200):TR$=CHR$(187):BR
    $=CHR$(188):VE$=CHR$(186):HO$=CHR$(205)
180 TITLE$(1)=TL$+HO$+HO$+TR$
190 TITLE$(2)=VE$+"PM"+VE$+" INDEX BUILDING S
    YSTEM "
200 TITLE$(3)=BL$+HO$+HO$+BR$
210 CLS:FOR CNT=1 TO 3:PRINT TAB((80-LEN(TITLE$(
    2)))/2);TITLE$(CNT):NEXT CNT
220 PRINT:PRINT "##LOAD INDEX & PRINT CHAINS##"
    :PRINT
230 '-----** GET DATE INDEX DATA **
240 INPUT "Enter DATE index file name (def.=B:TE
    ST001.IN1) ",IN1.NAME$
250 IF IN1.NAME$="" THEN IN1.NAME$="B:TEST001.IN
    1"
260 OPEN "R",#4,IN1.NAME$,36+51#B
270 IF LDF(4)=0 THEN CLOSE #4:KILL IN1.NAME$:PRI
    NT "FILE DOES NOT EXIST - PLEASE REENTER ":GOTO
    240
280 FIELD #4,14 AS S.FILE$,2 AS S.RLEN$,2 AS DPS
    N$,14 AS I2.FILE$,2 AS IN2PSN$,2 AS IN2LN$, 51#4
    AS DTAB$, 51#2 AS FWDTAB$, 51#2 AS BWDTAB$
290 GET #4,1
300 F.NAME$=S.FILE$:RECLN=CVI(S.RLEN$):I2.NAME$
    =I2.FILE$
310 DATPOS=CVI(DPSN$):IN2POS=CVI(IN2PSN$):IN2LEN
    =CVI(IN2LN$)
320 PRINT "Input file name is ";F.NAME$;" record
    length =";RECLN
330 PRINT " DATE index begins a
    t byte";DATPOS
340 PRINT "2nd index filename is ";I2.NAME$

```

Program 3.

operation is available on this file, and this is displayed for verification. Numeric data is held in string format and is recovered using the appropriate instructions CVI and CVS.

After the program has set up each index table there is a line of commented-out code which may be used for printing it. Once set up, each element of the index tables is used

to access the forward data chains. Selected information is printed from each record and the length of each chain is given. The corresponding backward chains may be obtained by replacing FWD with BWD in FWD%, DFWD\$, KEYFWD%, and IFWD\$ in the sections of the program which follow Date Chains — FWD.

The effectiveness of chaining depends to some extent on the distribution of chains across the disc. If data is arranged so that related records are held close to one another, physical I/O can be minimised.

Another enhancement can be made by ordering chains. If the records occur in sequence it will be possible to follow the chain backwards if certain values are exceeded. Different indexes produce conflicting requirements in this optimising process. To give the most efficient access using the date index the file should be sorted in date sequence; for access by the group index, records should be sorted by group.

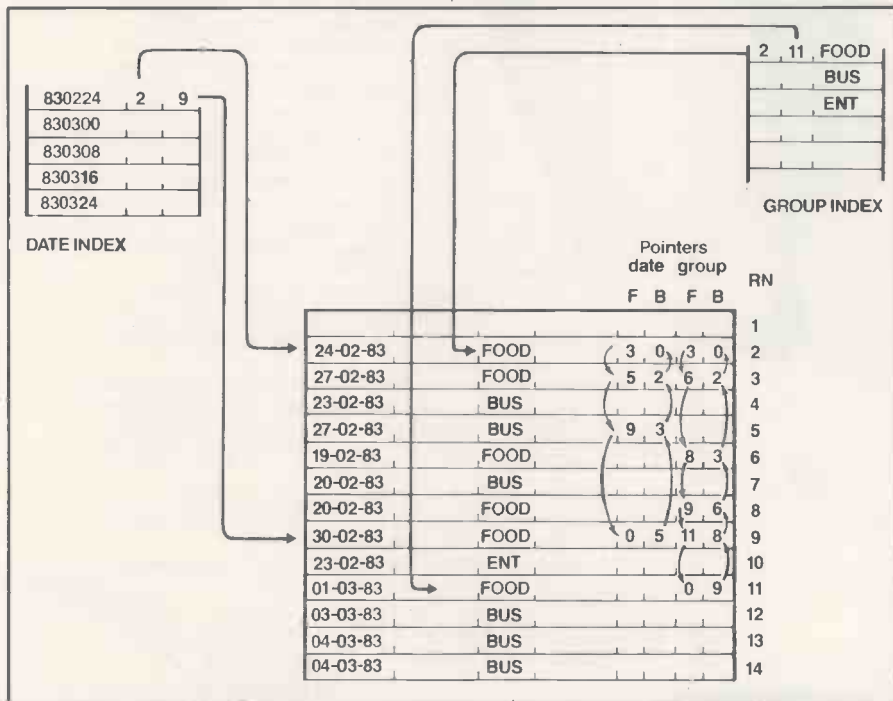

The Basic programs create two index/pointer chains that interact with the data file.

Reduced time

By adding part of program 3 and a few lines of table-searching logic to my enquiry program, and without sorting the data file, I have reduced the time for the worst case search of Finance File from 120 seconds to 17 seconds. However, this change has serious implications in file maintenance.

The introduction of some of the logic from program 2 into my file-maintenance program would enable the indexes and pointers to be kept up to date reasonably easily. Alternatively, the index file could hold one new value for the number of the then last record on the file. New data could be accessed in the enquiry program through a new search category which read the file records starting at $lr + 1$.

```

350 PRINT "                2ND index begins a
t byte";IN2POS;" length =";IN2LEN
360 PRINT:PRINT "Is this data correct (enter y/n
)"
370 IK$=INKEY$:IF IK$="" THEN GOTO 370
380 IF IK$="y" OR IK$="Y" THEN GOTO 410
390 IF IK$="n" OR IK$="N" THEN PRINT "RUN ABORTE
D":BEEP:GOTO 950
400 BEEP:GOTO 370
410 DIM TDAT!(50),FWD$(50),BWD$(50) '-----*
#FORMAT DATE INDEX TABLE**
420 FOR I=0 TO 50
430 TDAT!(I)=CVS(MID$(DTAB$,4*I+1,4))
440 FWD$(I)=CVI(MID$(FWDTAB$,2*I+1,2))
450 BWD$(I)=CVI(MID$(BWDTAB$,2*I+1,2))
460 NEXT
470 'FOR I=0 TO 50:PRINT TDAT!(I),FWD$(I),BWD$(I
):NEXT
480 CLOSE #4
490 '-----** GET 2ND INDEX DATA **
500 OPEN "R",#4,IN2.NAME$,20*(IN2LEN+4)
510 IF LOF(4)=0 THEN CLOSE #4:KILL IN2.NAME$:PRI
NT "INDEX2 FILE NOT FOUND - RUN ABORTED ":GOTO 9
50
520 FIELD #4,20*IN2LEN AS KEYTAB$,20*2 AS KEYF
WD$,20*2 AS KEYBWD$
530 GET #4,1
540 DIM KEYVAL$(20),KEYFWD$(20),KEYBWD$(20)
550 FOR I=0 TO 19
560 KEYVAL$(I)=MID$(KEYTAB$,IN2LEN*I+1,IN2LEN)
570 KEYFWD$(I)=CVI(MID$(KEYFWD$,2*I+1,2))
580 KEYBWD$(I)=CVI(MID$(KEYBWD$,2*I+1,2))
590 NEXT
600 'FOR I=0 TO 19:PRINT KEYVAL$(I),KEYFWD$(I),K
EYBWD$(I):NEXT
610 CLOSE #4
620 '-----**READ FILE USING INDEX CHAINS**
630 OPEN "R",#4,F.NAME$,RECLEN
640 IF LOF(4)=0 THEN CLOSE #4:KILL F.NAME$:PRINT
"INPUT FILE NOT FOUND - RUN ABORTED":GOTO 950
650 FIELD #4,DATPOS-1 AS FILLER1$,8 AS INDAT$,R

```

```

ECLN=8-8-DATPOS+1 AS FILLER2$,2 AS DFWD$,2 AS
DBWD$,2 AS IFWD$,2 AS IBWD$
655 FIELD #4,IN2POS-1 AS FILLER3$,IN2LEN AS ININ
X$,RECLN-IN2LEN-IN2POS+1 AS FILLER4$
660 LRECNUM=INT(LOF(4))/188
670 '-----** DATE CHAINS - FWD **
680 PRINT "##DATE CHAINS FORWARD##"
690 FOR I=1 TO 50
700 PRINT "INDEX DATE=";TDAT!(I)
710 IF FWD$(I)=0 THEN GOTO 800
720 RECNUM=FWD$(I)
730 MORE.CHAIN=1:CHLEN=0
740 WHILE MORE.CHAIN
750 GET #4,RECNUM:CHLEN=CHLEN+1
760 PRINT "R"RECNUM;"-";INDAT$;
770 PTR%=CVI(DFWD$(I))
780 IF PTR%=0 THEN PRINT "CHAIN LEN=";CHLEN:MORE
.CHAIN=0 ELSE RECNUM=PTR%:PRINT " ";:GOTO 750
790 WEND
800 NEXT
810 '-----**2ND INDEX CHAINS - FWD **
820 PRINT "##2ND INDEX CHAINS FORWARD##"
830 FOR I=0 TO 19
840 PRINT "INDEX VAL=";KEYVAL$(I)
850 IF KEYFWD$(I)=0 THEN GOTO 940
860 RECNUM=KEYFWD$(I)
870 MORE.CHAIN=1:CHLEN=0
880 WHILE MORE.CHAIN
890 GET #4,RECNUM:CHLEN=CHLEN+1
900 PRINT "R"RECNUM;"-";INDAT$;"(";ININX$;")";
910 PTR%=CVI(IFWD$(I))
920 IF PTR%=0 THEN PRINT "CHAIN LEN=";CHLEN:MORE
.CHAIN=0 ELSE RECNUM=PTR%:PRINT " ";:GOTO 890
930 WEND
940 NEXT
950 END
960 '-----** SAVE PROGRAM **
970 SAVE "B:TEMPSAVE.BAS"
980 KILL "B:INXLOAD.BAS"
990 NAME "B:TEMPSAVE.BAS" AS "B:INXLOAD.BAS"
1000 BEEP:PRINT "B:INXLOAD.BAS replaced!"

```

The key to Computing Power

Only by using the right software can a computer system successfully perform the required application. Get it wrong and the results can be costly and frustrating. But how can you be sure of having the best software available? How can you be sure of unlocking the full potential of your micro, mini or mainframe?

Software '84 is the key to systems success, as it offers visitors the opportunity to keep up to date with the latest developments in programming languages, operating systems, systems and applications software, fourth generation software tools and expert systems.

Software '84 is sponsored by 'Software', the UK's first specialist software magazine, Computer Weekly and the National Computing Centre.

The whole software industry is behind the show which has the full support of the Computing Services Association and the Institute of Data Processing Management, plus the co-sponsorship of 'Systems International', 'Practical Computing', 'Micro Business' and 'Computer Talk'.

For those people who want to listen to leading software industry experts and discuss the latest advances, the Software '84 Conference, held simultaneously, offers you a unique opportunity.

For full conference details phone NCC Seminars Department on 061 228 6333 or tick the box in the coupon below.

Make sure of your visit to this major event by using the coupon below to apply for advance registration tickets.

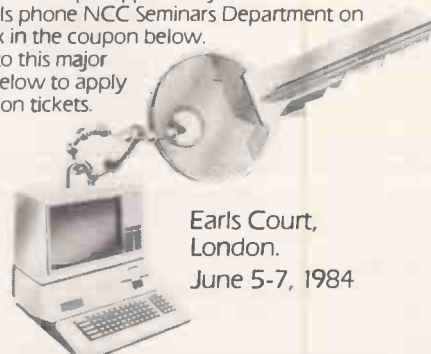

Earls Court,
London.
June 5-7, 1984

software '84

EXHIBITION AND CONFERENCE

The Exhibition is open daily 09:30-18:00
(except Wednesday 6th, closing 19:00)

Admission is by business registration. Entrance is FREE
if tickets are obtained in advance or £2 at the door.

Return to: The Exhibition Manager, **Software '84**, Reed Exhibitions, Surrey House, 1 Throwley Way, Sutton, Surrey SM1 4QQ

I am interested in visiting '**Software '84**'. Please send me a visitor registration form.

I am interested in attending '**Software '84**' Conference. Please send details.

Name _____ Position _____

Company _____

Address _____

Telephone No. _____ Telex _____

software '84

EXHIBITION AND CONFERENCE

COLOURJET

7 COLOUR INK JET PRINTER

Logic seeking in dot address mode

£499 + VAT

With Centronics parallel interface and free BBC Micro dump listing.

Options available:

- Buffered RS232 interface.
- Viewdata & RS232 interface.
- Apple II interface.
- IBM PC dump.

Specifications:

640 dots/line.

84 dots/inch both axes.

Friction feed rollpaper with single sheet feed A4.

37cps in full colour.

Ink cartridges, 4 million character life.



from BBC Micro screen — ½ size mode

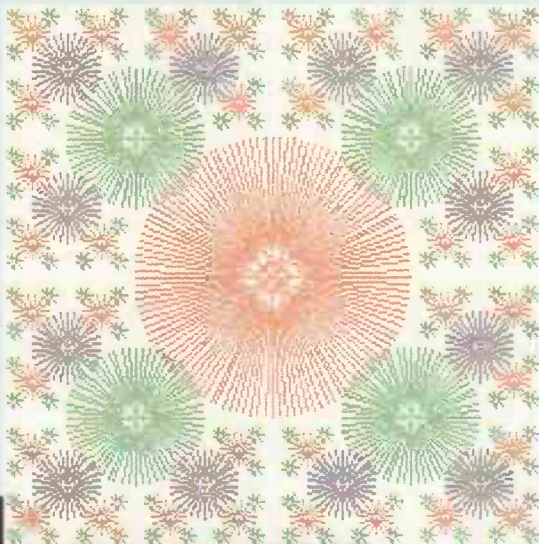

Virtually silent

INTEGREX LTD.

Church Gresley, Burton-on-Trent, Staffs DE11 9PT

Tel: 0283 215432 Telex: 377106

Dealers, OEM & Educational enquiries welcome

Circle No. 128

SERIOUS SOFTWARE FOR THE 64



DATABASE SYSTEM



WORD PROCESSOR

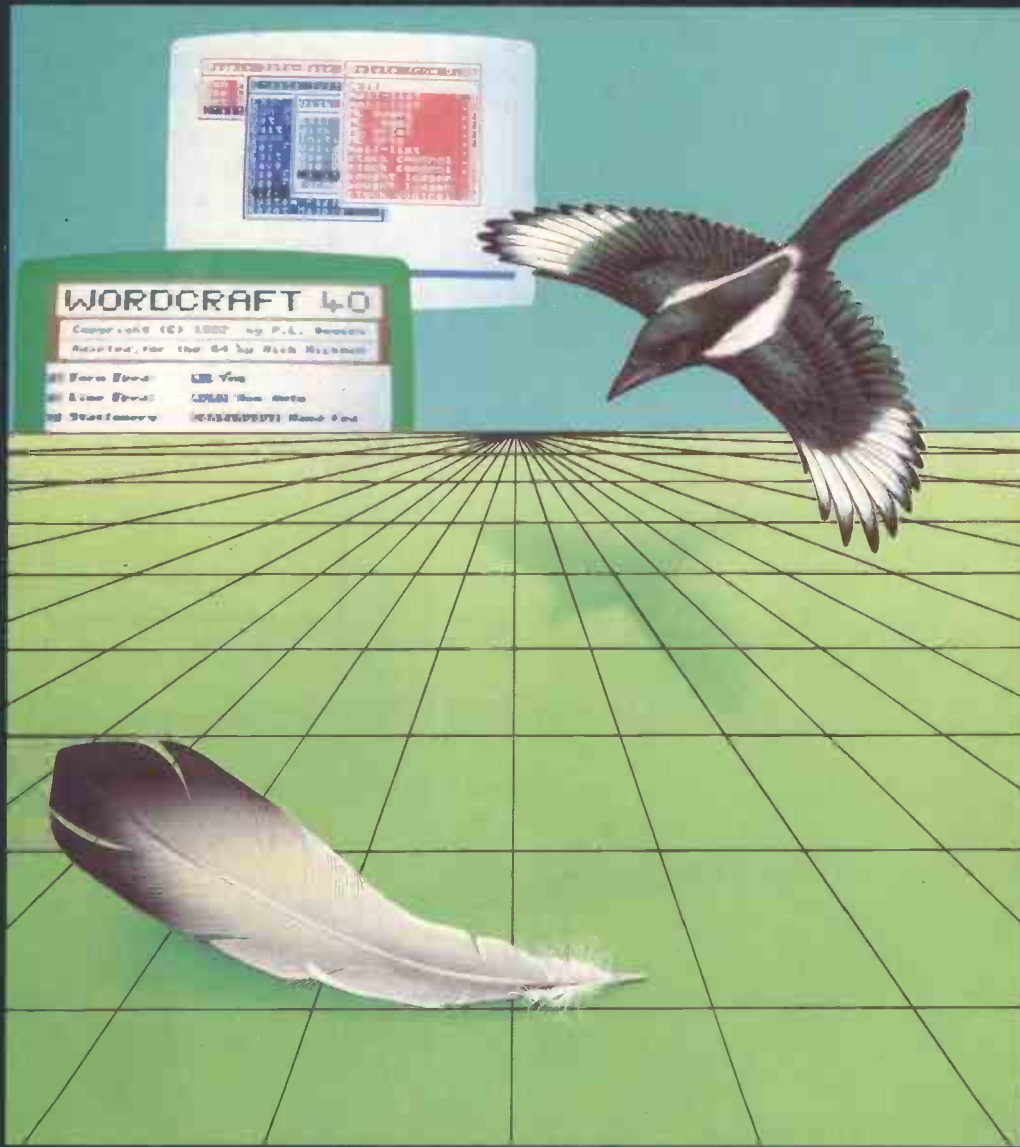

**MAILING LIST, INVOICING, STOCK CONTROL, SALES LEDGER,
BOUGHT LEDGER, DIARY, EXPENSES, CHEQUE BOOK!**

Now there is one program which can handle all these things

- MAGPIE -

The most powerful Database System for ANY Home Micro!

WORDCRAFT 40 gives you all the powerful Word Processing facilities of an office system at a fraction of the cost. WORDCRAFT 40 works with any printer and because it comes on cartridge you can use it with disk or tape files!

SEND FOR FURTHER DETAILS NOW !

PLEASE SEND ME FURTHER DETAILS OF
MAGPIE AND WORDCRAFT 40

Name
Address

AUDIOGENIC LTD
P.O. BOX 88
READING
BERKS.
RG5 8A

● Circle No. 253

Audiogenic LTD

Microware and IBM -We're unbeatable.

We promise to:

- Analyse and identify your requirements.
- Supply and install your equipment.
- Provide the widest range of software support.
- Offer comprehensive maintenance contracts.
- Take pride in our unparalleled after-sales service.

**Compare
our prices**

SOFTWARE

OPEN ACCESS - LOTUS EATER

- Only £475.00
- Database
- Spreadsheet
- 3-D Graphics
- Word Processor
- Appointments Diary
- Communications

LOTUS 123 - £375.00

- Database
- Spreadsheet
- Graphics

WORD PROCESSORS

- WordStar - £245.00
- Microsoft Word/Mouse - £340.00
- Multimate - £340.00
- Wordcraft - £425.00
- Word Perfect - £340.00

DATABASE PACKAGES

- dBASE II - £375.00
- DMS - £195.00
- Delta - £495.00
- Everyman - £475.00
- Knowledge Man - £350.00

ACCOUNTANCY PACKAGES

- Auditman - £1500.00
- Minuteman - £750.00
- Pegasus - £295.00 each
- Sales Ledger
- Purchase Ledger
- Nominal Ledger
- Invoicing
- Order Processing
- Stock Control
- Payroll
- Job Costing

**MULTI-USER
SOFTWARE**



HARDWARE

BASIC SYSTEM

- IBM Personal Computer
64K RAM, Single sided Disk
Drive
Keyboard, Screen - £1567.00
- IBM Personal Computer
128K RAM, Twin 360K Drives
Keyboard, Screen - £2087.00

BUSINESS SYSTEM

- IBM Personal Computer
256K RAM, Twin 360K Drives,
Keyboard, Screen - £2299.00

HARD DISK SYSTEM

- IBM Personal Computer
128K RAM, 10Mbyte Hard Disk,
Single 360K Floppy Drive
Keyboard, Screen - £4078.00

HERCULES GRAPHICS CARD

- Additional Cost only £185.00

COLOUR SYSTEMS

- Additional Cost only £405.00
- Send telexes from IBM PC -
£1750.00

APPLE LINK

- Quadlink turns PC into Apple -
£495.00

ARABIC IBM PC

- Conversion to Arabic - £590.00
- Arab Word Processor - £595.00

PRINTERS FROM £250.00

- Epson FX-80 FX-100/LQ1500
- Brother HR15/HR25
- NEC Spinwriter
- Sheet Feeders Available
- Typeface Catalogue Available
- Acoustic Hoods from £295.00

VARIOUS SELECTION

- PC Tutor 2.0 - £41.00
- CBasic - £140.00
- Pascal/MT+ - £420.00
- Microsoft 'C' - £384.00
- Chess - £61.00
- Norton Utilities - £56.00
- Backgammon - £35.00
- Electronic Disk - £50.00
- Copy II pc - £29.00

THE PROFESSIONALS

- Full training provided
- Free 12 months warranty
- Leasing deals arranged
- Highly competitive quotations
- Long and short term rentals

IBM

Personal
Computer

IBM Authorised Dealer

MICROWARE

BUSINESS SYSTEMS

637 HOLLOWAY ROAD, LONDON N19 5SS

TELEPHONE 01-263 1124 TELEX 297598

● Circle No. 139

NEW

SPECIAL OFFER for CBM 64

80-COLUMN/GRAFICCARD

- Digital clock
- Mixpossibility of 80-column screen with Hires CBM64-screen (also in colour)
- Grafic pictures; can be switched to background
- Upper line can be locked (for comments etc.)
- Adjustable line spacing for greater clarity on text screens

FREE ADDED! Sophisticated Wordprocessor with extended manual

£ 59.95

★ Warning: Beware of (Inferior) imitations of ZERO-products!

...Surprising Bargains for VIC 20 and CBM 64

<p>EXPANSION UNIT</p> <p>with 2 slots</p> <p>£ 5.95</p>	<p>EPROM CARD</p> <p>two 2k/4 k EPROM sockets</p> <p>Addresses are changeable.</p> <p>£ 5.95</p>												
<p>40/80 COLUMN CARD</p> <p>Turn your VIC 20 into a professional computer. 40 or 80 columns instead of 22, very sharp and stable picture. Try it out without obligation!</p> <p>£ 55.95</p>	<p>EPROM PROGRAMMER</p> <p>for 2716, 2732, 2764, 27128, 2532 EPROMS</p> <p>Can be easily connected to your computer. £ 31</p> <p>Control software in EPROM. £ 6.50</p>												
<p>64 k RAM + 2 k EPROM</p> <p>With software for RAM-files. Easily connected.</p> <p>£ 55.95</p>	<p>EPROM-ERASER</p> <p>erases 4 EPROMS simultaneously</p> <p>£ 26.50</p>												
<p>EXPANSION UNIT</p> <p>With 5 slots, fully buffered, switches for deselecting slots, and on-board power supply</p> <p>VIC 20 £ 29.95 * CBM64 £ 36.95</p>	<p>MACH3 PRINTER BUFFER</p> <table border="1"> <tr> <td></td> <td>16 k</td> <td>32 k</td> <td>48 k</td> </tr> <tr> <td>par. input - par. output</td> <td>£ 86</td> <td>£ 98</td> <td>£ 109</td> </tr> <tr> <td>serial input - par. output</td> <td>£ 94</td> <td>£ 109</td> <td>£ 123</td> </tr> </table> <p>for all our products: Dealer inquiries invited.</p>		16 k	32 k	48 k	par. input - par. output	£ 86	£ 98	£ 109	serial input - par. output	£ 94	£ 109	£ 123
	16 k	32 k	48 k										
par. input - par. output	£ 86	£ 98	£ 109										
serial input - par. output	£ 94	£ 109	£ 123										

zero ELECTRONICS

149 KINGSTREET + GT. YARMOUTH NR30 2PA + TEL: (0493) - 2023 (NASH HOUSE)

- All prices exclude VAT. Shipping costs £ 1.50
- Supplier to schools, unversities and government departments.
- We have good documentation of all our products, free of charge.
- All equipment can be tried out without obligation; if returned undamaged within 10 days, you only pay postage and packing costs.

0493

• Circle No. 140

What Qualities do you need in your word processor?

- Tick Where appropriate.
- Software produced in the USA.
 - Little or no support except at transatlantic call rates.
 - Displays full screen of text for editing and uses commands that are easy to understand.
 - Combinations of escape and control characters that require a pocket command reference card to be handy at all times or continual reference to help screens.
 - Runs on a large number of microcomputers under the CP/M operating system.
 - Only the software need be purchased for your hardware.
 - Handles proportionally spaced printing, retaining clean left margins in columns or indented text.
 - Catalogues disks including full titles and dates.
 - Allows viewing of other documents while editing.
 - Costs only £345 including mail merging.
- Ticked boxes 1, 2 or 4? Chances are you are already firmly entrenched on some other word processor. If you ticked one or more of the other boxes, find out more about:

VER-WORD The Word processor for CP/M by writing to Verwood Systems (Dept WMG), Verwood House, High Street, West Haddon, Northants NN6 7AP specifying your machine type, disk size, terminal type and printer.

• Circle No. 141



The Panther

A superb printer at a printable price

The Panther has arrived. A fast, sleek, good looking printer from DATAc that's leaving other printers standing. Just look at the features that make The Panther the most exciting printer available today:

- Friction feed and tractor feed for varying paper widths.
- A Viewdata character set as standard.
- Bi-directional logic seeking carriage.
- Centronics interface as standard.
- Compatible with the BBC Micro and most micros.

All this plus more for only **£278,** + VAT + p.p.
Place your order today. Complete the coupon and send to DATAc at the address below.



DATAc

DATAc LIMITED, Tudor Road, Altrincham, Cheshire WA14 5TN. Tel: 061-941 2361 Telex: 667822 CHACOM G

Please rush me my Panther DX109 for which I enclose a cheque/Access/Barclaycard

(No _____) for £328.70

Please send me further details of the Panther DX109

I would like a demonstration. Please send me details of my local stockist.

Please send me details on the range of DATAc printers.

(Please tick box)

Name _____

Address _____

Telephone _____

24 Hour Express Delivery. P&P charge £9.

DATAc LIMITED, Tudor Road, Altrincham, Cheshire WA14 5TN.
Tel: 061-941 2361 Telex: 667822 CHACOM G

PC5/84

• Circle No. 142

Look over the Rainbow with Microware.

We offer you:

- Free 12 months on-site warranty.
- 4-hour on-site response at modest cost.
- Computer-based instructions.
- Free Digital training vouchers.
- Generous trade-in allowances.



SOFTWARE

LOTUS 123

- only £375
- Database
- Spreadsheet
- Graphics

PEGASUS

- only £295 each
- Sales Ledger
- Purchase Ledger
- Nominal Ledger
- Invoicing Ledger
- Order Processing
- Stock Control
- Payroll
- Job Costing

INCOMPLETE RECORDS

- Ideal for Accountants
- Auditman - £1500
- Minuteman - £750

DEC GP

- Practice and Patient Records
- Health Service information to FPC
- Reduces Clerical and Professional Workloads
- Produces repeat prescriptions
- Analysis of practice data
- Secure against unauthorised access
- Totally Integrated System

VARIOUS SELECTION

- Multiplan
- TK! Solver
- Select Wordprocessor
- WordStar/Mailmerge
- Wordcraft
- dBASE II

THE PROFESSIONALS

- Full training provided
- Leasing deals arranged
- Long or short term rentals
- Highly competitive quotations
- Book your demonstration now!

HARDWARE

RAINBOW 100B

- 128K RAM, Twin 400K Drives
- Amber or Green Monitor
- Keyboard, MS DOS, CPM 80/86
- Self teach disk, Stand and Customer Services Package - £2767

RAINBOW 100B + LA50 PRINTER

- As above but with LA50 - £3276

RAINBOW 100B + LA100 PRINTER

- As above but with LA100 - £4017

RAINBOW 100B + LQPO2 PRINTER

- As above but with LQPO2 - £4755

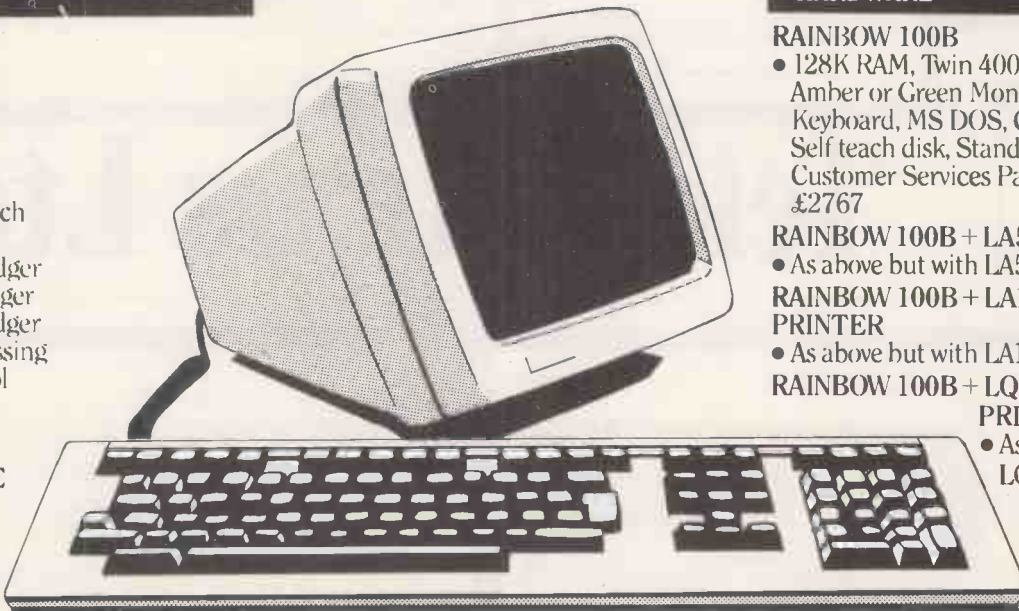

RAINBOW 100 + HARD DISK

- 128K RAM, Twin 400K Drives
- 10 Mbyte Hard Disk,
- Choice of Screens
- Keyboard, CPM 80/86, MS DOS,
- Self teach disk, stand and Customer Services Package - £4200

COLOUR SYSTEMS AVAILABLE

- Additional cost only £820

AUTHORISED
digital
PERSONAL COMPUTER DEALER

MICROWARE
BUSINESS SYSTEMS
637 HOLLOWAY ROAD, LONDON N19 5SS
TELEPHONE 01-263 1124 TELEX 297598

● Circle No. 143

SOFTWARE CENTRE

CP/M

CP/M-86

MSDOS

MICROPRO SOFTWARE SYSTEM

WORDSTAR: Best selling professional Word Processing software; On screen formatting, Block manipulation, File read/write, Simultaneous Editing and Printing £295
MAILMERGE: Enhancement for document personalisation and mailing applications £145
SPELLSTAR: Enhancement for checking spelling and maintaining spelling dictionaries £145
STARINDEX: Useful package for creation of Table of Contents, Index, List of Figures, Interfaces to Wordstar to improve document presentation quickly and easily £116
INFOSTAR: Impressive Data Base system combining the power of Dastar with the flexibility of Reportstar £295
DATASAR: Screen based Data Entry, vetting and retrieval system. Screen formats under user control £175
REPORTSTAR: Powerful report generator, provides much needed enhancement to Dastar for report production and transaction processing £210
CALCSTAR: Electronic spreadsheet with interfaces to all MicroPro products £116

NB: Combination prices — WS/MM
 £390; WS/MM/SP/SI £495

DATABASE MANAGEMENT

FORMULA II: Unique information management system with exceptional capabilities for Application Generation. Multiple files and indexes, transaction processing, interactive, no programming language required £495
dBASE II: The most popular of data management systems, very powerful application generator £437
QUICKCODE: Add-on facility for dBASE programmers to speed development process by generating dBASE command files £200
dGRAPH: Extremely useful program for graphical representation of dBASE and user created data files £200
dUTIL: Utility to speed up dBASE execution £69
CARDBOX: Highly popular electronic card index system. Easy to use, with powerful retrieval facilities £155
FRIDAY: End user file management system from the authors of dBASE II: File definition, input and reporting under user control £195
RESCUE: UK written database management system £295
DMS: Well accepted data management system from Comsoft £195

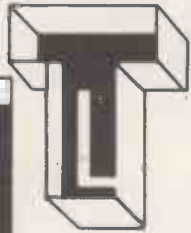

Telesystems Ltd

PO Box 12 Great Missenden Bucks Tel: 02406 5314

LANGUAGES

Microsoft	CP/M	MSDOS	Digital Research	CP/M	CP/M-PCDOS	86
BASIC Interpreter	£259	£269	CBASIC Interpreter	£100	£217	
BASIC Compiler	£295	£303	CBASIC Compiler	£333	£400	£400
FORTRAN Compiler	£369	£269	PASCAL/MT+	£233	£400	£400
COBOL Compiler	£549	£575	C Compiler	£233	£233	
C Compiler		£384	PERSONAL BASIC Int		£100	
PASCAL		£269	CIS COBOL	£425	£425	
BUSINESS BASIC		£460	FORMS-2	£110	£110	
Comp			FILESHARE	£250	£425	
MACRO ASSEMBLER	£149					
SUPERSOFT C Comp	£185	£185	SUPERSOFT BASIC	£200	£200	
PRO FORTRAN	£220		Compiler			
			PRO PASCAL	£220	£320	£320

UTILITIES

ASCDM: The most flexible asynchronous communications package available to the micro world. Interactive, batch, menu-driven. Available for CP/M, CP/M-86, MS/PCDOS £135
BSTAM: Simple communications program for exchanging files between CP/M systems £135
TRANSFER: System for exchanging files between CP/M systems. Provided with full 8080 source code £130
CONVMS: Operating system converter. Runs MSDOS programs under CP/M-86 £70
CONVCP: Operating system converter. Runs CP/M-86 programs under MSDOS £70
SID/ZSID: Disassembler for 8080 and Z80 programs £69
DISKEDIT: Facility for editing disk held data by sector. Invaluable aid £70
IBM-CP/M COMPATIBILITY: Set of programs that enable IBM 3740 disks to be used on CP/M, permitting transfer of files to/from IBM mainframes £110
SPP: Speed Programming Package for use with Pascal/MT+ £133
XL86: Converts 8080 assembler code to 8086 £106
EM80/86: Emulator to run CP/M software under CP/M-86 £70
DISPLAY MANAGER: Screen handling productivity aid for Digital Research compilers £267
ACCESS MANAGER: File handling productivity aid for Digital Research compilers £200

APPLICATIONS

MULTIPLAN: Exceptional electronic worksheet from Microsoft £199
MULTI-TOOL WORD: Microsoft's advanced Word Processor with optional Mouse for added flexibility £275
SUPERCALC: Fast action spreadsheet and planning aid £200
MICROMODELLER: Financial planning system for model building £250
GRAPHSTAT: Versatile statistics and graphics package for the Epson QX10, IBM-PC and Sirius £195
ALIAS ACCOUNTS: Fully integrated accounts system with inbuilt hooks to dBASE II £1200
ALIAS PAYROLL/SSP: Standalone or integrated system with optional links to ALIAS accounts each £600
RCS LEDGERS: Sales, Purchase, Nominal ledgers in MBASIC source code each £300
RCS PAYROLL: Full function, highly used package £500
STATISTICS PACK: Over 25 easily used routines in MBASIC £120
MATHS PACKAGE: Interactive routines (40+) in MBASIC £120

MISCELLANEOUS

CP/M 2.2: Standard operating system on 8" disk £100
CP/M-86: Standard 16-bit operating system £167
SUPERSORT: Full function Sort/Merge/Selection package £145
MSORT: Standalone and COBOL hosted Sort package £143
MAGSAM: MBASIC utility to provide multi-key ISAM file facilities £130
TOUCH 'N' GO: Teach yourself keyboard skills £25
MICROSOFT MOUSE: Mouse, interface card and software £140
OPTIMISER: Interactive Linear Programming package £325
PROSTAR TRAINING GUIDE: Independent instruction on the use of MicroPro 'STAR' products £30

PLEASE CALL FOR FULL LIST

DEALER ENQUIRIES INVITED

80-BUS SOLUTIONS

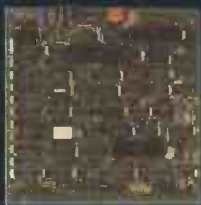

GM813—CPU/64K RAM Board

- * 4MHz Z80 CPU
- * 64K Dynamic RAM
- * RS232 Serial Interface
- * Two 8-Bit I/O Ports
- * 1200 Baud Cassette Interface

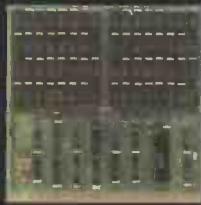

GM833—512K RAM-DISK

- * 512K Dynamic Memory
- * Simple Software Interface
- * Switching Allows Multiple Boards
- * High-speed Silicon Disc

GM816 MULTI-I/O Board

- * 6 I/O Ports
- * 4 Counter/Timer Channels
- * Real Time Clock
- * Further Expansion Capability

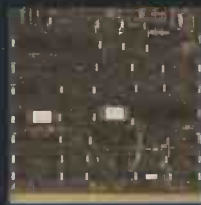
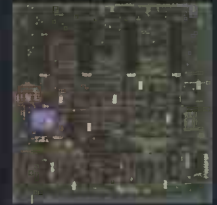

GM812—IVC Board

- * 80x25 Display Format
- * On-board Z80A Microprocessor
- * Programmable Character Generator
- * 160x75 Pixel Graphics
- * Light Pen Input



GM829—FDC/SASI Board

- * Single/Double Density Operation
- * Single/Double Sided Drive Support
- * Up to 4 mixed 5.25" and 8" Drives
- * Industry Standard SASI Hard Disk Interface

TWO SPARE SLOTS

The Galaxy 3 computer shown has two empty slots, in a 5-board 80-Bus format, for simple addition of Gemini Multiboards to develop your own requirements.



EV814—IEEE488 Controller

- * Cost Effective Controller
- * Comprehensive Software Supplied



IO828—Colour Graphics Processor Board

- * 640x576 Bit Mapped Display
- * On-board 16-Bit Microprocessor
- * Comprehensive On-board Software



GM811—CPU Board

- * Z80A CPU
- * RS232 Serial Interface
- * 2x8-Bit I/O Ports
- * 4 Byte-wide Memory Sockets



GEMINI MULTIBOARDS ARE AVAILABLE LOCALLY FROM:

AMERSHAM, BUCKS
Amersham Computer Centre,
Woodside Road,
Tel: (02403) 22307

BRISTOL
Target Electronics Ltd., 16 Cherry Lane
Tel: (0272) 421196

LEEDS
Bits & PC's, Leeds Computer Centre,
62 The Balcony, Merrion Centre,
Tel: (0532) 45887

LONDON W2
Henry's Radio, 404 Edgware Road
Tel: 01-402 6822

LONDON SW11
OFF Records, Computer House,
58 Battersea Rise, Clapham Junction
Tel: 01-223 7730

MANCHESTER M19
EV Computing, 700 Burnage Lane
Tel: 061-431 4866

NOTTINGHAM
Computerama, (Skytronics Ltd.)
357 Derby Road
Tel: (0602) 781742

The Gemini MultiBoard Microsystem provides a range of 15 fully-compatible microcomputer boards, which can be used to configure solutions for micro processor problems, from as many as 10 boards, to just 1. This flexibility is due to Gemini's adoption of accepted industry standards; especially the 80-Bus, specifically designed for the Z80 microcomputer which forms the heart of the MultiBoard system.

The principle advantage of a Z80 Bus system is the abundance of software available operating under CP/M, by which software becomes machine independent; providing the user with the widest range of software available.

There is also the opportunity to develop systems based on the Galaxy 3 computer (shown above) which uses Gemini MultiBoards, but has 2 spare slots in a 5-board frame for particular configurations. Alternatively, the Galaxy 2 provides a cost-effective development tool with 3 spare slots in a 6-board frame.

With MultiBoard thousands of permutations are possible. Eight of our most popular boards are shown here, but there is a range of 15 available; together with mother boards, frames, cables, power supplies, key boards and compatible software if required. A comprehensive catalogue is available from the Dealers listed, or 'phone us to discuss your requirements.



18 Woodside Road, Amersham, Bucks HP6 5EQ. Tel: (02403) 28321.

● Circle No. 145

The MTX Series described; straight from the author's mouth

MANUAL

The first section (of the manual) is a basic tutorial. The grass roots information is here and I could not find any major mistakes. The second part is on Noddy giving a good guide as to how it can be written. . . . The third and fourth sections are on graphics and sound. Both are quite detailed and easy to follow. The fifth section is on how to interface Assembler to Basic.

Personal Computing Today Feb 84.

The provisional manual, which runs to some 250 A4 size pages, has a wealth of detail for the machine-code specialist.

Electronics and Computing Monthly.

INTEGRATED INTERACTIVE SOFTWARE

The MTX ROM has been designed to allow the maximum interaction between components of the software. A single program can be written which uses NODDY to display text and graphics, and a BASIC control program which calls routines written in assembly code. This is a feature of future generation computers not available on any other micro.

BASIC

The Basic is fast and accurate, all the calculations being done in floating point maths, so that you don't lose accuracy to gain speed.

Personal Computing Today Feb 84.

The latest addition to the Memotech range DMX80 Matrix Printer - 80 characters per second print speed, eight character formats, dot addressable graphics, £295.00 including VAT.



Integrated Software - a five to one advantage. Assembler/Disassembler, High resolution Graphics, Arcade style games, Noddy for easy text handling and Front Panel for testing and debugging machine code.

NODDY

A language new to me called Noddy is included in the MTX which is designed to make text handling easy, especially for beginners.

Hobby Electronics.

Also provided is the easy to use beginner's language (Noddy) and a child oriented learning language Logo.

Practical Computing Dec 83.

(Noddy has only 11 commands) that need to be mastered before some quite complex question-and-answer-type programs can be written.

Your Computer Nov 83.

Noddy's . . . main use is for displaying text and I can see applications in the computer assisted learning (CAL) field. Writing in Noddy is like a mixture of Logo and Forth.

Personal Computing Today Feb 84.

ASSEMBLER/DISASSEMBLER

The Assembler can be accessed through BASIC. When used in conjunction with the PANEL it enables the programmer to single step through

and test machine code programs. This is not new to computing, but it is to a home micro.

As well as being able to modify and disassemble sections of code, you can set break points, examine and alter register values, and even single step through code. I hope other Z80 micro manufacturers (particularly in the Cambridge direction) take note of these debugging aids.

Popular Computing Weekly Nov 83.

The Assembler is called from Basic, and it assembles the code in situ, as part of the Basic listing.

Hobby Electronics.

Z80 BOARD

The MTX Series is a more powerful tool for education than the 6502 because it produces a more powerful assembler, allows the PANEL function to be used, and enables integrated software to be written.

RML's 450Z has a (PANEL) function but that is a computer which costs considerably more than the MTX 500.

Hobby Electronics.

FULLY INTEGRATED AND EXTENDED GRAPHICS

The only aspect of the series where extensions to standard language are allowed is in the most comprehensive and integrated graphics available on a home micro.

32 Sprites are supported either 8 x 8 or 16 x 16. They are easy to use and define and do not use extra memory as in the . . . because they have their own area of RAM.

Personal Computing Today Feb 84.

Graphics are very easy to create and manipulate, even for beginners.

Which Micro Jan 84.



MTX512 plus twin 5 1/4" disc FDX. A CP/M based business system – £1245 inc VAT.

SOUND

The simplification of the sound commands for ease of programming has in no way compromised the quality of the sound produced.

Sound is of great importance for use in games but on many microcomputers it is inadequate. Not so with the MTX... *Your Computer Nov 83.*

As well as good graphics capability the MTX boasts the same sound chip as the BBC micro – the Texas 76489. It has three tone channels and one noise channel, and is easily controlled from Basic. Volume and frequency can also be controlled, using a much easier method than the 14 parameters needed by the BBC.

Popular Computing Weekly Nov 83.

The commands are sufficiently complex to enable the computer to be used as a synthesizer.

Electronics and Computing Monthly.



Input/Output Monitor, Hi-Fi, Power, TV, Centronics, Cassette Mic and Ear, and two Joystick ports all come as standard; the twin RS232 ports are available as expansions.

HARDWARE

Inside the case is what one comes to expect from Memotech – a very neat PCB that holds all the components including the main chips – namely a Z80A processor and TMS 9929 graphics chips as well as about 30 others.

If you are familiar with the ZX81 peripherals that Memotech also make you will know that the company has an eye for good design and does not skimp on materials it uses.

Electronics and Computing Monthly.

CP/M OPERATING SYSTEM

The Series is designed to run under the CP/M operating system. This is the Disc Filing System used on the vast majority of microcomputers in business. Since a program written on one CP/M machine can be transferred and run on almost any other, this makes available 15,000 CP/M based business programs. The powerful LINK program can give access to any device operating under CP/M. With its excellent software support and because of its modular nature, the series is a cost-effective and efficient entry to serious business and educational computing.

FULL-TRAVEL KEYBOARD

It has a professional quality keyboard. This and its elegant styling make it suitable for word processing and business use.

Your Computer Nov 83.

NODE RING

MTX computers can operate together without expensive network systems. Units linked via the ring can share software peripherals and communicate with each other. Many other makes of computer can be interfaced with the ring as terminals.

EDUCATIONAL USAGE

There will be many people who have seen a front panel display on the 380Z computer in secondary schools or

colleges, and the MTX panel is very similar.

Hobby Electronics.

The new language Noddy and the Logo type Turtle Graphic commands would appeal particularly to the growing education market.

Your Computer Nov 83.

Applications are obviously going to suggest themselves in areas of the school curriculum, the fast-training of personnel in commerce, and in adventure-game writing.

Hobby Electronics.

The MTX expansion potential is well thought out. The key to both the MTX Ring system and to the Disc Drive systems is the communications (RS232) board mentioned earlier.

Electronics and Computing Monthly.

UPGRADABILITY

The MTX 500/512 is part of an existing range of products which can be bought separately and integrated into a single powerful system, now.

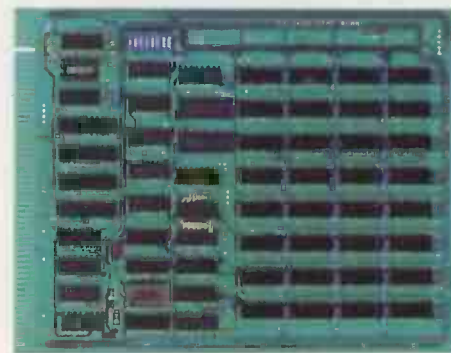

Silicon Disc RAM Board 256K fast access RAM

There is plenty of room for expansion with the MTX and Memotech have planned a progression up to their small business machine with 80 column display (instead of the standard 40 x 24) Floppy discs, Silicon (or RAM) discs, and a hard disc under development.

Personal Computing Today Feb 84.

There are a multitude of sockets along the back consisting of two Joystick sockets, cassette connections, Centronics printer circuit, aerial socket, power socket and audio and video output. There is also provision for two RS232 sockets...

Popular Computing Weekly Nov 83.

MEMOTECH

Station Lane Industrial Estate
Witney, Oxon, OX8 6BX.
Telephone (0993) 2977
Telex: 83372 MemtecG.

67
MTX 500 - VOTED
PRODUCT OF THE YEAR
BY COMPUTER TRADE ASSOCIATION
MEMOTECH
MTX
SERIES

BLOBBO
NOW AVAILABLE
FOR THE ZX SPECTRUM

SOFTWARE FOR THE
MTX
SERIES

CHESS

A fully comprehensive chess package. Ten levels of play, from novice to championship standard. Pitch your wits against the computer with this fast, versatile machine code program.

TOADO

The object of the game is to navigate each of **five toads** across a road and **two rivers** without being run down or drowning (toads can't swim).

ALICE IN WONDERLAND

A fully interactive machine code adventure game set in **Wonderland**. You play the part of **Alice**, and explore the fascinating world of Wonderland, full of excitement and suspense. Delve deep into tunnels, caves and wells in search of hidden treasure.

KILOPEDE

Eliminate **mushrooms** and the descending segmented **Kilopede** to gain bonus points – avoid killer **crabs**, **fleas**, **spiders** and **jellyfish** which chase you across multiple levels of increasing difficulty.

SUPER MINEFIELD

The object of the game is to get from one side of the minefield to the other without being **blown up**. You only get one life so be careful – not all the mines are visible. The only way you can tell how many mines are nearby is by looking at the **mine detector** in the top right hand corner of the screen.

BLOBBO

Run at high speed around the maze collecting **treasure** and **fruit** worth bonus points – but don't get caught by the **Blobbo-eaters**! Tactical dodging must be employed to avoid them. If you're caught or step on a skull and crossbones you lose one of your three lives.

KNUCKLES

Move **Knuckles** around his maze, using a joystick to kick **Roks** and **Magic Squares**. The object is to line up the **Magic Squares**, using the fire key, and so advance to the next level, gaining a level bonus.

Please send for our free colour catalogue of Business, Education and Games Software.

Illustration: Nick Mynheer.

Continental Software Limited,
Unit 23, Station Lane,
Witney, Oxon

• Circle No. 147



Xerox telecopier

Send a document across the world in just two minutes with a Xerox facsimile terminal. It speeds up business and means important decisions can be made immediately. And there's a model to suit your exact need. The Xerox Telecopier 455 sits conveniently by your telephone. The 485 can handle up to 30 originals and receive up to 300 pages at a time. For bulk transmission the 495 can transmit an A4 letter in under a minute; its auto dial facility can make calls and transmit documents 24 hours a day.

426 on enquiry card

Clear crisp copies

If you require needle sharp, edge to edge copies, clear black and white from virtually any colour, the Roneo 230 Copier from Roneo Alcatel will suit you. It produces 30 copies per minute, has a touch sensitive keyboard to minimise misfeeds and a key control to monitor usage. The 230 will copy standard documents, books, flimsy originals, even three dimensional objects, onto standard bond, address labels, etc in sizes A3, A4, B4 and B5. An automatic sorter and feeder are also available. Contact me for further details.

427 on enquiry card

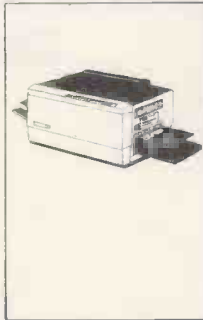

PP

PAGE PLUS Computers

COMPILED BY-

Christina Hewitt

65 Shawley Way, Epsom Downs
Surrey KT18 5PD 07373 52031

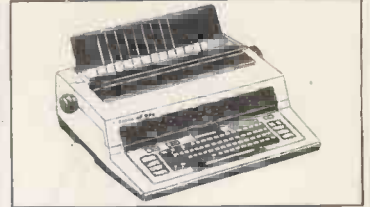

Canon AP350 simple sophistication

The Canon AP350 typewriter offers sophisticated electronic capabilities in a low priced, easy to operate, machine. A liquid crystal display allows corrections to text before typing and the electronic memory can store text and formats for a later time. The AP350 has a friendly keyboard similar to an electric typewriter. Electronic function keys are on either side of main keyboard for easy access and operation. The Canon AP350 can be interfaced with the RS232C and helps you take the next step towards office automation. I have full details.

432 on enquiry card



Twinlock VDU furniture range — new additions

Twinlock have extended their successful VDU furniture range with the addition of two VDU workcentres. One is designed to accommodate separate VDU screens and keyboards with a height adjustable platform that tilts back and forth to avoid eye-strain or glare. The other is fixed and designed for an adjustable VDU, or an integrated VDU and keyboard system. Both have an extra large work surface which will accommodate a table-top printer. Optional accessories, such as a printout catcher and a 5-tray housing are also available. Just circle this number.

428 on enquiry card

To all hardware and software manual users

Send a section from your software/service/repair manual, parts list or even the mag tape from your mainframe computer and Micromedia will prepare, free of charge and without obligation, a demonstration microfiche containing your information plus a comprehensive free quote to convert your parts manuals into easy to use microfiche. For the busy engineer on the road, some readers plug into a car cigar lighter socket enabling you to have your records to hand. Let me put you in touch with Bell & Howell.

429 on enquiry card

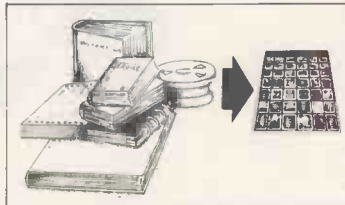

Canon AP400 smart and silent

The Canon AP400 electronic typewriter has a host of features that will delight you. Smart looking and with a 500 character correction memory, the AP400 will automatically centre text between margins, tabs and words or around any carrier position. This typewriter will also interface with the RS232C. Other features include right hand alignment, underlining, bold lettering, automatic carrier return and paperfeed and decimal tabulation with numerical punctuation. The AP400 is yet another step towards office automation. I can put you in touch with Canon.

433 on enquiry card

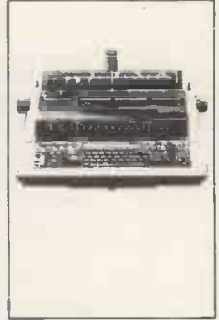

The last word in dictation

The BM 550 portable dictator from Sony's MicroWorld range has all the features that enable easy and efficient dictation. This slim and sleek portable, weighing less than seven ounces has a slide switch for one hand operation, electronic indexing for better communication with the secretary and the micro cassette flexibility of up to two hours recording. Circle this number now and I'll be happy to send you all the details.

434 on enquiry card

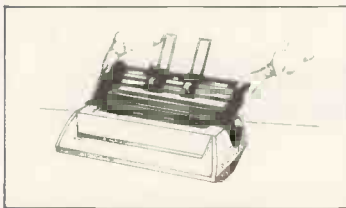

Fully automatic sheet feeder

Now you can eliminate the time consuming job of feeding single sheets into your printer. The Easifeed is fully mechanical, clips onto the printer and will take over 100 sheets, A3 wide and 14in deep. High volume mailings have never been so fast or cost effective. A reverse print operates over 20 lines, ideal for producing graphs, and a by-pass feature allows manual feeding without interrupting the normal workflow. WBM Business Supplies will demonstrate this reliable sheet feeder on your own printer. Just circle this number.

430 on enquiry card

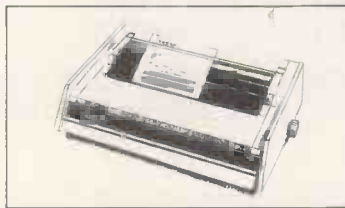

The Trend 930 printer means business

The latest addition to Trend's successful 900 series of high speed printers is the 930 printer. This versatile machine gives dual mode printing. When your letters need to create the best impression select the Executive Quality 80 characters per second, with the daisywheel look-alike finish. For office memos, etc, choose the Draft Mode with its quick 200 cps speed. The 930 will handle cut sheets and multi-part fanfold forms. Optional sheet feeder available. Contact me now for more details of this superior WP printer.

431 on enquiry card

Acoustic hood trial offer

Noise from printers is a problem. It disrupts both machine operator and staff nearby. Telephone calls are difficult and lost concentration leads to reduced output. WBM Business Supplies want you to hear for yourself the deadening quality of the Grenadier Acoustic Hoods and experience the relief of a quieter environment. That's why they're offering you a free seven day trial. The Grenadier is modern and stylish in design with a smoked perspex viewing panel. You'll be impressed with the difference. Simply contact me.

435 on enquiry card

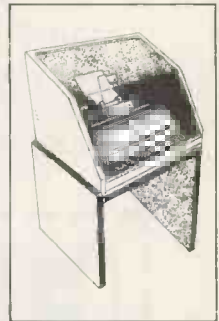

Computer print-out shredders

The increasing use of word processors, printers and computer installations means that Business Aids' electronic Scimitar Data Shredders are in greater demand than ever. The Compact Data 1001 is ideal for the smaller computer user; models 2001 and 2002 accept 25 sheets or eight streams of continuous stationery, while the high security 2002XC converts paper into illegible 2 x 15mm chips. Data 4001 is a wide-throated console model; the heavy duty Data 5000 and 6000 have a 30-sheet capacity and process up to 20 streams of print-out simultaneously.

• Circle No. 148

436 on enquiry card

Some of the attractive figures you'll meet at

COMPEC NORTH '84

Belle Vue, Manchester

19-21 June 1984

72%
high-calibre executives

40%
responsible for purchases

36%
involved in purchases

COMPEC NORTH '84

COMPEC NORTH is the most influential computer show outside London.

It is THE ONLY northern computer show for DP professionals and serious business users.

And in just three days it gives you concentrated coverage of the most important part of your market: directors, DP managers, and other computing professionals from manufacturing industries, services, consultancies, systems houses, software firms and bureaux.

COMPEC NORTH is now in its fourth year, and once again is being sponsored and supported by the leading journals in the business.

So if you want to be at the centre of influence, reserve your stand now at COMPEC NORTH '84. From as little as £92 per square metre.

For your full information pack with booking details complete and return this form to: Chris O'Hea, Exhibition Sales Manager, Room L310, Quadrant House, The Quadrant, Sutton, Surrey SM2 5AS. Tel: 01-661 3125

COMPEC NORTH '84

THE WORLD OF COMPUTING IN THE NORTH

Compec North is sponsored by Computer Weekly, in association with Computer Talk, Systems International, Practical Computing, Software and Micro Business.

Please send me my full information pack about exhibiting at COMPEC NORTH '84

Name _____

Position _____

Company _____

Address _____

PC

PRESENT A SERIES OF COMPUTER APPRECIATION WEEKENDS

Computers are the fastest moving area of the 80s and keeping up to date with all the developments is more and more difficult; which micro computer do you really need? How much should your business efficiency increase with a micro? How much of the salesman's jargon do you believe?

All these questions and many more will be answered at a series of computer appreciation weekends, which will be held at Ladbroke Hotels. They will give Business Executives an opportunity to benefit from the advice and experience of independent computer consultants.

Your Weekend Programme starts with a welcome cocktail reception on Friday followed by dinner with wine.

Saturday will be divided into a number of sessions and guests will be welcomed by their own personal desk-top computer - an Epson QX 10, and with this in front of them, there will be an outline of what computers can and cannot do and the principals of creating a program.

After lunch, guests will be able to experiment with a series of packages and there will be demonstrations on financial modelling, accounting suites, and communications.

On Sunday, guests will present their specific business problems, and a full discussion will follow. The weekend will close with a traditional Sunday lunch.

The Price: Your complete computer weekend is £160.00 PER PERSON, inclusive of VAT. The price includes individual advice and tuition, use of microcomputers, welcome cocktail, 3 course dinner on Friday and Saturday, Full English Breakfast on Saturday and Sunday and traditional Sunday lunch.

All rooms have private bathroom facilities, colour T.V., radio, telephone and welcome tea and coffee tray. There is a £10 single room supplement.

Computer Weekends:
Ladbroke Dragonara Hotel,
Leeds - May 4-6, 1984.

Ladbroke Dragonara Hotel,
Bristol - June 22-24, 1984.

Ladbroke Hotel, Basingstoke
- September 21-23, 1984.

To make your booking or for further details, telephone Iris Henry on (0923) 45186 Ladbroke Hotels Computer Weekends, PO Box 137, Watford, Herts. WD1 1DN.

Registered in England No. 841059.
Registered address V Quadrant, Sutton, Surrey.

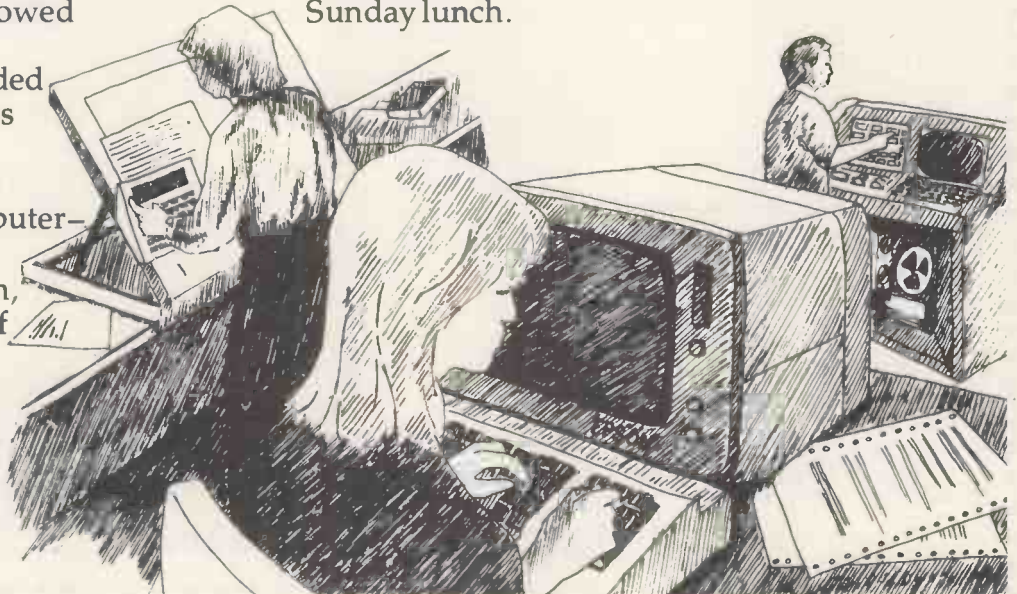

● Circle No. 189

ELBUG FOR THE ACORN ELECTRON

IF YOU HAVE AN ACORN ELECTRON OR ARE THINKING OF BUYING ONE THEN YOU SHOULD JOIN THE ELECTRON USER GROUP.

Members receive 10 copies of the magazine **ELBUG** each year. **ELBUG** is devoted **EXCLUSIVELY** to the **ELECTRON MICRO**. It is packed with news, Reviews, Hints, Tips, Programming ideas. Major articles, plus Regular program features including games and useful utilities.

ELBUG, is produced by **BEEBUG Publications Ltd.**, publishers of **BEEBUG**, the magazine of the National User Group for the **BBC Micro**. **BEEBUG** now has some **20,000** members, and has achieved a high reputation both in this country and abroad. **Acorn** and the **BBC** have both taken out multiple memberships, for example, and our articles are now syndicated in **Australia**. (For further details of **BEEBUG**, see separate advertisement elsewhere in this issue.)

The formula which makes **BEEBUG** an invaluable companion for users of the **BBC micro** will be applied to **ELBUG**. By subscribing to **ORBIT** you gain all the advantages of a single-micro magazine, with no space wasted on programs and articles for other computers.

Further benefits of membership:
Members' discount scheme with national retailers of software, hardware and books, with savings of up to 25%.
Members' software library with a growing range of titles at special prices for members.

SPECIAL OFFER SUBSCRIBE NOW, AND GET A FREE INTRODUCTORY CASSETTE CONTAINING 8 TESTED PROGRAMS FOR THE ELECTRON.

- SPACE CITY** Defeat the invading Aliens with your laser, and save the city.
- 3D NOUGHTS AND CROSSES** Pit your wits against the **ELECTRON** on a 4x4x4 board.
- RACER** Guide your racing car to victory, avoiding other cars and obstacles on the track.
- 3D MAZE** In this challenging game, you must escape from the maze — The screen displays a 3D view from inside the maze.
- PATCHWORK** A multicoloured display of continuously changing patterns.
- KEY SET ROUTINE** A program to set up the user function keys.
- MEMORY DISPLAY** An efficiently written utility to display the contents of memory (ROM and RAM).
- CHARACTER DEFINER** Define individual graphics characters with this useful utility for use in your own programs.

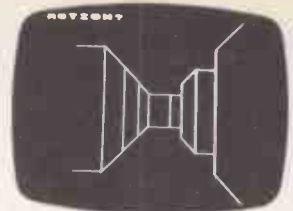

BEEBMAZE



RACER

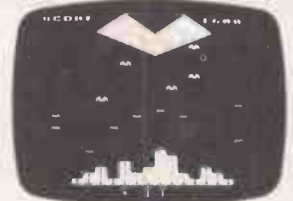

SPACE CITY

HOW TO JOIN

To subscribe for one year, and get your free cassette, send £9.90 (payable to Orbit) plus a strong stamped addressed envelope (for the cassette) to:

ORBIT, PO BOX 109, High Wycombe, Bucks HP11 2TD

SIX MONTH TRIAL SUBSCRIPTION (5 ISSUES) UK ONLY £5.90 — FREE CASSETTE OFFER STILL STANDS.

Membership outside UK (one year only): **Fire and Europe £16, Middle East £19, America & Africa £21, other countries £23.**

Editorial address **BEEBUG Publications, PO Box 50, St Albans, Herts, AL1 2AR**

● Circle No. 149

LOWEST PRICES

Immediate export quotes available · Maintenance or insurance available on all equipment. ALL PRICES ARE EXCLUSIVE OF V.A.T.

DAISYWHEEL PRINTERS

BROTHER HR1	449.00
BROTHER HR15	345.00
TRACTOR	65.00
SHEETFEEDER	190.00
KEYBOARD	140.00
BROTHER HR25	555.00
DAISY STEP 2000 (20cps)	246.00
DIABLO 620 (RO)	675.00
DIABLO 630 (API)	1320.00
DIABLO 630 TRACTOR	149.00
JUKI 6100	335.00
TRACTOR	89.00
SHEETFEEDER	199.00
QUME 11/40 (RO)	1190.00
QUME 11/55 (RO)	1375.00
QUME 9/45 (RO)	1590.00
QUME 9/55 (RO)	1940.00
RICOH RP 1300 (P or S)	899.00
RICOH FLOWWRITER 1300	999.00
RICOH RP 1600 (P or S)	1239.00
RICOH FLOWWRITER 1600	1299.00

ALL OTHER PRINTERS AVAILABLE:

FUJITSU, NEC, OLYMPIA, TEC, UCHIDA, SILVER REED, SMITH CORONA, OLIVETTI.

DOT MATRIX PRINTERS

ANADEX DP 9000	799.00
ANADEX DP 9620	949.00
ANADEX 9725 (Colour)	1099.00
COMMODORE MTS 801	175.00
EPSON RX80T	215.00

EPSON RX80F/T	240.00
EPSON FX80	325.00
EPSON MS 100F/T III	370.00
EPSON FX100F/T	425.00
HERMES 612C (inc. Tractor)	1650.00
OTHERS AVAILABLE	
MANNESMANN TALLY MT 80	200.00
MANNESMANN TALLY MT 160	399.00
MANNESMANN TALLY MT 180	599.00
OKI MICROLINE 80A	199.00
OKI MICROLINE 82A	259.00
OKI MICROLINE 83A	399.00
OKI MICROLINE 84(P)	635.00
OKI MICROLINE 84(S)	709.00
OKI MICROLINE 92(P)	399.00
OKI MICROLINE 92(S)	449.00
OKI MICROLINE 93(P)	499.00
OKI MICROLINE 93(S)	549.00
OKI MICROLINE 2350(P)	1449.00
OKI MICROLINE 2350(S)	1499.00
OKI MICROLINE 2410(P)	1549.00
OKI MICROLINE 2410(S)	1599.00
RADIX 10(NLO)	449.00
RADIX 15(NLO)	549.00
SEIKOSHA GP100A	179.00
SEIKOSHA GP100VC	175.00

SEIKOSHA GP250X	215.00
SEIKOSHA GP700A (Colour)	369.00
SHINWA CP80 F/T	185.00
SHINWA 40 (Colour)	119.00
STAR GEMINI 10X	209.00
STAR GEMINI 15X	309.00
STAR DELTA 10	319.00
STAR DELTA 15	425.00
TEC 1550(P)	469.00
TEC 1550(S)	499.00

MANY OTHERS AVAILABLE:

DRE-NEWBURY, I.D.S. MICROPRISM, RITEMAN, TEXAS, TOSHIBA.

COMPUTERS

APRICOT 256K 1x315K D/D+MON	1400.00
APRICOT 256K 2x315K D/D+MON	1550.00
COMMODORE VIC 20	78.25
COMMODORE VIC 20 STARTER PACK	108.69
COMMODORE 64	152.17
EPSON QX10	1649.00
ORIC ATMOS 48K	145.00
SINCLAIR ZX81	33.00
SINCLAIR ZX81 16K	53.00
SINCLAIR SPECTRUM 16K	80.00
SINCLAIR SPECTRUM 48K	100.00
SIRIUS '1' 128K 1.2MB	1650.00
SIRIUS '1' 256K 2.4MB	2150.00
SIRIUS '1' 256K 1.2+10.6MB	2950.00
TELEVIDEO 1605	2245.00
TELEVIDEO TS802	2875.00
TELEVIDEO TS800A	1075.00

MANY OTHERS AVAILABLE.



2nd Floor, Spa House, Wimbledon, London SW19 4JS **Tel: 01-947-8562** Telex: WOWICO 8955888

● Circle No. 150

PayRight

Payroll software you can trust

PAYRIGHT IS A HIGHLY RELIABLE PAYROLL PACKAGE, DESIGNED TO MEET THE MOST EXACTING REQUIREMENTS. IT MAY BE USED BY YOUR EXISTING CLERICAL STAFF, AND NO TECHNICAL KNOWLEDGE IS NEEDED.

- * Sixty different pay elements and deduction types.
- * Wide choice of payslip style, with all payslip stationery easily available off the shelf.
- * Fully conforms to statutory requirements for PAYE, NIC, and SSP. Rates may be changed by the operator in minutes.
- * Equally suitable for payroll bureaux and for companies' own wages departments.

PAYRIGHT RUNS ON MOST CP/M-BASED MICROS. PRICES FROM £300 TO £500 DEPENDING ON FEATURES. DEMONSTRATION PACK £50, REFUNDABLE AGAINST SUBSEQUENT PURCHASE. TRADE ENQUIRIES WELCOME.

From the payroll experts:

MIKE LEWIS CONSULTANTS LTD.

48 Willoughby Road, London NW3 1RU. Tel: 01-794 3886

Please send full details of PAYRIGHT, without obligation.

PC2.

Name _____
Position _____
Company _____
Address _____
Postcode _____
Type of business _____

● Circle No. 152

Analysts/Programmers

£8,000-£15,000 PSION 

We are a leading microcomputer software house with an outstanding record of growth and profitability, active in the fields of business applications, systems and home entertainment software.

We are currently recruiting analysts/programmers with microcomputer experience and experience of VAX VMS, C, MS-DOS, 8086, 68000, Z80, 6502, Cross Assemblers or Simulators.

Competitive salaries are offered, based on relevant experience. This is an exciting opportunity to join a young, dedicated and highly trained team in one of Britain's fastest growing companies.

Apply in writing, enclosing a Curriculum Vitae to: The Recruitment Manager, Psion Ltd, 2 Huntsworth Mews, Gloucester Place, London NW1 6DD

● Circle No. 151

EVERY

 **commodore**

64

DESERVES A DATABASE

No matter what your business or interest, with **Superbase 64** you have a totally flexible 'record' system, as big as you want it, as fast as you need it.

Create your own formats, enter your records, change layouts and data fields.

Superbase 64 gives you unrivalled control in home or office, business or professional practice, with an extensive range of features.

Superbase 64

The complete information control system for the Commodore 64. By the authors of "Easyscript", the Commodore No. 1 word processing system.

 **Superbase 64**
Precision Software Limited
6 Park Terrace
Worcester Park, Surrey KT4 7JZ
Telephone: 01-330 7166
Telex: 8955021. PRECIS G

● Circle No. 153

The Flagship...



In keeping with a long tradition of producing fine quality dot matrix printers, Epson have now launched their new flagship. The LQ-1500 is a new breed of printer, that will give you the best of both worlds. A dot matrix printer, although capable of 200 CPS in draft mode, can be set to produce letter quality at 66 CPS by simply flicking a switch.

Like all Epson products, versatility has been a primary consideration of the LQ-1500, incorporating friction feed as standard with optional tractor and hopper feed and a carriage width of a full 15".

You now have at your fingertips

all the advantages of a daisywheel machine, in terms of quality, together with the added benefits of condensed or enlarged characters and proportional spacing, plus very high speed when set to operate in draft form.

Having superb graphics capabilities and optional 8-bit parallel (Centronics) RS 232 and IEEE interfaces, the LQ-1500 has taken

its rightful place at the head of the Epson fleet of fine dot matrix printers.

Epson have been leading the field in the design and production of printers for many years. Printers that are now successfully operating in all kinds of business environments, like the ever popular RX-80 and FX-80. With speeds of 100 CPS and 160 CPS respectively, dot addressable graphics and optional tractor feed available on the FX model, these two machines are extremely reliable and widely used.

The RX-80F/T has the same

The Fleet



advanced features as the RX-80 but having both friction and tractor feed as standard, it's a totally versatile machine at a thoroughly realistic price.

With an ever watchful eye on the changing face of the printer market, Epson have identified a growing need for a high speed printer with the ability to accept wider paper. Thus was born the FX-100, again including all the advantages of its predecessors.

Epson are always looking for ways to improve products, a policy which has kept us one step ahead during a lifetime of being the first name in printers.

Fill in the coupon now to find out which member of the Epson printer family meets your requirements.



EPSON

**Extraordinary product.
Exceptional quality.**

Epson (UK) Limited, Freepost,
Wembley, Middlesex HA9 6BR.
Sales Enquiries: Freefone EPSON.
General Enquiries: 01-902 8892.
Telex: 8814169.

- I would like a demonstration of the LQ-1500 printer.
- Please send me details of my local stockist.
- Please send me details of the range of Epson printers.

Name _____

Position _____

Company _____

Address _____

Tel: _____

PCS/DMP

QUME

TWO OF A KIND



The SPRINT 11 Plus with operator interchangeable interfaces – and the SPRINT 12/20 both daisywheel printers with Qume superb design and letter-quality print.

SPRINT 11 Plus with a choice of 40 cps. or 55 cps. which incorporate the unique Qume operator interchangeable interface modules that fit most popular computers, through the range of R.S. 232C, I.E.E.E. and Centronics interfaces.

SPRINT 12/20 with a good speed (20 cps.) for business, professional or home use. Engineered by Qume to give years of reliable service and available at an attractive price. Interface compatibility with most popular micro computers. Compact design – user friendly. Uses Qume standard Printwheels and Ribbons the most accessible range available in the U.K. Options include – Forms Tractor, Letter Guide or Sheet Feeder

Qume[®]
Qume (UK) Limited,

Bridgewater Close, Reading, Berkshire RG3 1JT
Tel: Reading (0734) 584646 Telex: 849706

A British Company of **ITT**

Qume®

**Distributor
Network
UK and Ireland**

P = Printers.
V = Video Terminals.
M = Disk Drives.

- PV** Access Data Communications Ltd
Uxbridge, Middlesex UB8 2RT.
Tel: 0895 59781
- PV** Alphatech Computer Systems Ltd
Bourne End, Buckinghamshire SL8 5SP.
Tel: 06285 28237
- PV** Bytech Ltd
Reading, Berkshire RG6 1AZ.
Tel: 0734 61031
- PV** Daisy Terminals Ltd
Haywards Heath, West Sussex, RH16 1UA.
Tel: 0444 457546
- PV** Data Ltd
Altrincham,
Cheshire. WA14 5TN. Tel: 061 941 2361
- M** Euro Electronics Ltd
London NW1 1YE. Tel: 01-267 5416
- P** Facit Data Products
Rochester, Kent. ME1 3QN.
Tel: 0634 401721
- PV** ISG Data Sales Ltd
Reading, Berkshire. RG7 1AW.
Tel: 0734 884666
- V** Northamber Ltd
Mill Road, Esher, Surrey KT10 9QA.
Tel: 0372 68311
- PV** Peritronic Ltd
Livingston, Scotland.
Tel: 0279 20411
- PV** Recall Information Systems Ltd.,
Dublin-18, Ireland.
Tel: Dublin 887361
- V** R.T.S. Technology Ltd.
London NW1 0BY.
Tel: 01-267 7541
- PV** Teleprinter Equipment Ltd
Ting, Hertfordshire. HP23 6AJ.
Tel: 044282 4011

Printwheels and Ribbons

ISA Ltd (Master Distributor)
Bradford, Yorks.
Tel: 0274 306787 & 01-992 3411

Facit Data Products
Rochester, Kent. Tel: 0634 401721

Willis Computer Supplies Ltd
Bishop's Stortford, Herts. CN23 3DN.
Tel: 0279 506491

Stylographic Services Ltd
Herts WD7 7NN. Tel: 09276 4585

Desco Carbon & Ribbon Supplies Ltd
Glasgow. G62 7SS. Tel: 041 956 1134

Willis Computer Supplies (Ireland) Ltd
Co. Dublin, Ireland. Tel: 0001 801470

Qume (UK) Limited,
Bridgewater Close, Reading, Berkshire RG3 1JT.
Tel: Reading (0734) 584646. Telex: 849706
A British Company of **ITT**



COMPUTER PARK '84

For a holiday you will never forget

Join other computer enthusiasts for a week full of exciting and imaginative computer activities. At Computer Park we gather together in one place more equipment and expertise than you are likely to come across anywhere else. You will have the opportunity to use: a variety of computers, robots, turtles, graph plotters, light pens, graphics tablets etc.

Here are just a few of the Computer Park features:

- * More computers than people!
- * Computer rooms open from 9am to 10pm
- * Programming techniques: utilities; games; expert systems etc.
- * Range of computer languages: Fourth, LISP, Pascal, machine code etc.
- * Activities suitable for beginners through to experts (more activities than you will have time for!)
- * Excellent supervision (lots of enthusiastic, talented staff).
- * Country House location.

Computer Park is a holiday designed specifically for those interested in computers. It is NOT simply an activity holiday with a computer option. Write or phone for our free brochure and judge for yourself.

Computer Park '84, 25 Bridge Street, Rothwell, Kettering, Northants. NN14 2JW. Telephone (0536) 712627.

● Circle No. 258

COMPUTERPRO LIMITED

Dept PC, 65 The Falstones, Basildon, Essex SS15 5DF.
Tel: 0268 412545
Cash and Carry By Appointment. Access Welcome

All orders which accompany a cheque, cash or postal order are carriage free (U.K. mainland). A carriage charge of 4% of invoice total is applicable on Credit Card and Official orders.
Ring for a quote on any printer on the market.

PRINTERS	£
JP101 the 'BBC' Spark Jet printer (P)	149.50
Shinwa-CT1 CP-80 80col, 80cps (P)	199.87
Ribbons for Shinwa printer (2)	12.88
Star Gemini 10 x 8K, 80col, 160cps (P+S)	219.88
Star Delta 10 8K, 80col, 160cps (P+S)	331.20
RS232 interface for Star DP/Star Gemini	51.75
Ribbons for Star printers (4)	11.96
Canon PJ1080A 80col, 40cps, 7 colour ink jet	422.51
Canon PW1080A 80col, 160cps, 27cps NLQ (P)	315.10
Canon PW1156A 136col, 160cps, 27cps NLQ (P)	391.00
Epson RX80T 80col, 100cps (P)	243.57
Epson RX80F/T 80col, 100cps (P)	278.30
Epson FX80P/T 80col, 160cps (P)	380.90
Epson MX100F/T 136col, 100cps (P)	412.85
Epson FX100F/T 136col, 160cps (P)	491.51
Ribbons for 80 column Epsoms (3)	12.42
Ribbons for 136 column Epsoms (2)	16.60
Smith-Corona TP-1 13" x 12cps (P/S)	219.88
Tractor Feed for TP-1	75.90
Ribbons for TP-1 S/S (6) £14.95; M/S (3)	19.55
Daisy Step 2000 13", 20cps (P)	272.09
Juki 6100 daisywheel printer (P)	379.96
Tractor Feed for Juki	103.04
Sheet Feeder for Juki	223.10
Ribbons for Juki (5) S/S £8.74; (2) M/S	11.73
Daisywheels for Juki (State type)	17.94
Brother EP44 A4, 16cps, (S-KSR)	211.14
Printer cables for BBC/Oric/Dragon	11.04
Printer cables for most micros	20.01
Com 64/20 I.F. (Cass) £29.90; (Disc based)	32.20
Kempton Sinclair printer interface unit	39.79
CW/P's Apple 11/11e I.F. + cable (Graphics)	46.00
RS232 2K interface for Epson & Shinwa	49.68
COMPUTERS	
Chiltern Electronics Unitron 2200	401.35
CW/P's Slimline disc drive unit (Apple)	149.96
Disc drive controller card (Apple)	42.55
BASF SS/SD 5.25" discs (Pack of ten)	13.80
Sanyo MBC 550/555 Computer (Ring for details)	
PROFESSIONAL MONITORS	
We only sell one type of monitor - the best!	
Acorn's official BBC monitor. BT approved.	
NOVEX 12" V.Hi-Res direct etch green	83.49
NOVEX 12" As above but in non-glare amber	95.91
NOVEX 14" Std-Res RGB, COMP VIDEO & SOUND	220.80
The above model looks, and has the same spec. as the Microvitec Cub 1431. Resolution equive to JVC Med-Res unit. Use as a high quality VCR monitor.	
NOVEX 14" Med-Res RGB (IBM Compatible)	353.51
NOVEX 14" High-Res RGB (IBM Compatible)	414.00

● Circle No. 259

OLIVETTI's new M-24 personal computer joins the ranks of the IBMulators. The unexpanded version runs the famous Microsoft Flight Simulator, which is a good test of compatibility. Because it uses the full 16-bit 8086 chip run at 8MHz, instead of an 8088 run at 4.77MHz, and because it has 128K of RAM as standard, it also offers more power than the IBM PC for what is expected to be less money.

In some ways the psychology of the M-24 is more interesting than the hardware. Launching an IBM PC compatible micro is something of a climb-down for Olivetti, which entered the micro market over a year ago with the Z-8001 based M-20 running its own operating system, PCOS. Since then Olivetti has been forced to offer an 8086 card for the M-20 to provide MS-DOS compatibility, and has signed a deal with Corona to manufacture its machine as the M-18. The final step of designing an IBMulator represents a defeat for Olivetti's original strategy.

At the same time it could be said to be a victory of pragmatism over ideology. If people want to buy an IBM-type micro Olivetti wants to sell them one; but if not, the M-20 is still there as an alternative. Thus the M-24 joins rather than replaces the Z-8001 machine in a combined attack on the micro market.

The striking thing about the M-24 is that

OLIVETTI M-24

Olivetti has finally swallowed its corporate pride and built an IBM look-alike. Jack Schofield runs it side by side with the real thing.

it does not look like an IBM PC, which the Columbia, Corona, Eagle, Tava and OSM PC do. The M-24, like all Olivetti products, has been styled in Italy. It shows some nice visual touches, though no conclusions should be drawn from the metal-cased prototype we photographed.

More compact

The M-24 is a three-box system like the IBM. The system box is somewhat smaller than the IBM's, though taller. Half-height Toshiba floppy-disc drives have been used,

so both drives are accommodated in the space needed by just one on the IBM PC. The main board has been tucked right into the bottom of the case, component-side down, with a metal lid folded over it. This can be done because there are no expansion slots on the main board. For expansion, a 16-bit bus is brought from the main board to a separate card on the left of the system box. Olivetti says that, if required, an extender can be fitted which will allow up to seven of the current eight-bit IBM PC expansion cards to be used. Three slots can be used for 16-bit cards.



The M-24 offers full compatibility with the IBM PC XT (right) but is housed in a smaller, neater box.

The IBM PC user always requires access to the expansion slots because the circuitry for the monochrome screen/printer driver comes on a card. Adding graphics then means adding a colour graphics adaptor card which, incidentally, will not drive the monochrome monitor. Other slots on the IBM PC may be used for extra RAM or comms facilities.

The M-24, by contrast, does not separate the monochrome/printer and graphics drivers. It has a single display controller which fits via an edge connector into the main board, so even with a monochrome screen you can run the Microsoft Flight Simulator, draw graphs and display four shades of grey.

The motherboard also has a built-in clock/calendar with battery back-up, space for an extra 128K of RAM, a serial port and a parallel printer port. A Reset button and green LED power indicator are provided on the front of the system box, with both male and female power sockets and a keyboard socket on the back.

Keyboard options

Two keyboards are available. One is the standard 96-key Olivetti design with 12 function keys across the top. The other features an IBM PC key layout with 10 function keys down the side. Both plug into the back of the system box via about 4ft. of tightly coiled cable and a nine-pin D connector which is not compatible with the IBM PC. The keyboard is under the control of an Intel 8041A microprocessor and can be configured for different national languages; the same can be done for the IBM PC.

The IBM-type keyboard has a couple of useful enhancements. Both the Caps Lock and Num Lock keys have built-in LEDs to show they are on, and there is a nine-pin D connector on the back for plugging in a mouse. I got the impression that the touch of the keyboard was not as good as the IBM original, but it would not be fair to make a

judgement solely by the prototype version I used.

Shades of grey

The monitor is physically the same as the one sold with the M-20, but has internal differences to provide shades of grey. It is plugged straight into the display controller outlet, does not require a separate power lead, and offers tilt and swivel plus brightness control. As well as the standard white on black, green and amber options are promised, and a colour display will be offered when a colour graphics card becomes available.

The M-24's highest graphics resolution is 640 by 400 pixels, compared with the IBM's 640 by 200. It is bit-mapped to 32K of RAM, compared to the 16K used by the PC XT. The Olivetti sans-serif character set is commendably readable when displayed on the non-glare screen. Other options on the M-24 are 640 by 200 pixels, 320 by 200 colour graphics and 80 by 25 colour characters, all provided for compatibility with the IBM PC.

The M-24 will not be supplied with an operating system. Users are invited to buy either MS-DOS, Concurrent CP/M or UCSD-p. With the addition of a Z-8001
(continued on next page)

Specification

CPU: Intel 8086-2 running at 8MHz; optional 8087 arithmetic processor
Operating system: MS-DOS version 2.11 or CP/M-86 or UCSD-p; PCOS with Z-8001 card
Memory: 128K RAM expandable to 256K on motherboard or to 640K total; 8K ROM with bootstrap and diagnostics, expandable to 32K
Bus: seven-slot expansion option with IBM PC XT compatibility
Discs: one or two 360K or 720K half-height floppy discs; optional 10Mbyte hard disc
Standard interfaces: Centronics parallel printer interface; RS-232C serial port
Features: clock/calendar with battery back-up

KEYBOARD

Type: detached, option of 96-key Olivetti or IBM PC layout
Features: IBM keyboard has auto-repeat, 10 function keys, numeric keypad, mouse port

DISPLAY

Type: detached 12in. monochrome with brightness control, up to 640-by-400-pixel or 80-by-250-character resolution; 16 shades of grey
Features: tilt and rotation; anti-glare screen

Dimensions: system box 380mm. (15in.) by 375mm. (14.8in.) by 165mm. (6.5in.)
Supplier: British Olivetti Ltd, Olivetti House, PO Box 89, 86-88 Upper Richmond Road, London SW15 2UR.
 Telephone: 01-785 6666

Benchmarks

The standard Benchmarks were run using Microsoft GWBasic 2.0 under MS-DOS v.2.11

	BM1	BM2	BM3	BM4	BM5	BM6	BM7	BM8	Av.
Olivetti M-24—Intel 8086	0.5	2.0	4.6	4.7	5.2	9.4	14.8	15.9	7.1
Olivetti M-20—Zilog Z-8001	1.1	4.0	8.0	8.4	9.2	17.1	26.5	12.0	10.8
IBM PC—Intel 8088	1.2	4.8	11.7	12.2	13.4	23.3	37.4	30.0	16.8

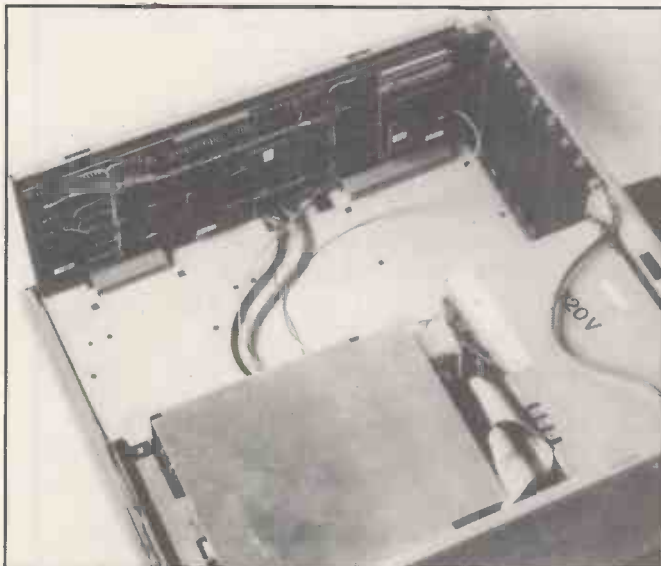

Most of the system box is air, with plenty of space available for IBM-compatible cards.

GW-BASIC 2.0
 (C) Copyright Microsoft 1983

Olivetti PC 1050 GW Basic v. 2.0 DEVELOPMENT

1 February 1983

61642 Bytes free
 Ok

New Microsoft GWBasic version 2.0 leaves 61,642 bytes free for programmers.

OLIVETTI M-24

(continued from previous page)

card you can even have PCOS. GWBasic comes with MS-DOS. Digital Research languages and some applications packages will also be available from Olivetti.

All the operating systems are supplied with Olivetti ring-bound manuals in the contemporary dwarf format. They are better written than the IBM versions, as though a good sub-editor has cut the American wordiness and use of the passive. For example, where the PC-DOS manual takes six pages to describe Print, the Olivetti version tabulates the material in 2½.

The GWBasic supplied for review was a new version 2.11 featuring a number of new commands such as MkDir for Make Directory, View and Window. The directory commands are those normally used with a hard disc, while the new graphics commands are concerned with Microsoft's window management.

In general, however, the M-24 will be used for running existing software designed for the IBM PC, using both PC discs and documentation. Some of the IBM packages tested on the M-24 were the Microsoft Flight Simulator, Trendtext

word processor, Software Arts' TK!Solver, Software Solutions' Dataease, Southdata's Superfile, IMSI's 4-Point Graphics — and even Microsoft's Multiplan in a Compaq version.

Everything seemed to work perfectly well. Ironically, 4-Point Graphics and the Flight Simulator will not run on our own monochrome IBM PC XT because it lacks graphics. Olivetti is claiming compatibility with the hard-disc IBM PC XT rather than with the standard PC that IBM launched first and which is different in a number of respects.

Upgrade path

One of the problems of making a look-alike is that you can be left behind when the machine you are emulating is enhanced. However, Olivetti seems to have done everything to ensure that the M-24 will stay upgradable. For example, the board is able to accept 256Kbit RAM chips in place of the current 64Kbit ones. The existing power supply is sufficient for a hard disc, which will use the Alloy PC-Star cartridge for back-up.

The 5.25in. floppies fitted can be used in quad-density mode to provide 640K of storage, an option which IBM will presumably go for eventually. As mentioned earlier, a 16-bit expansion bus has already been provided. A portable version of the M-24, to be designated the M-21, is also in the works.

Conclusions

● The prototype shown here is not the final version. Even so, the Olivetti M-24 looks attractive and takes up significantly less desk space than an IBM PC.

● The M-24 appears to be functionally compatible with the IBM PC. It runs the Microsoft Flight Simulator and other programs written and formatted for the IBM PC. The amount of current PC or PC XT software that will not run must be small.

● Ergonomically the M-24 is a good machine with a highly legible screen display. Judgment must be suspended on the quality of the final keyboard, but Olivetti has made enough keyboards of one kind or another to deserve the benefit of the doubt.

● The M-24 is significantly faster and more powerful than the IBM PC, should not need a colour graphics card to run popular programs like Lotus 1-2-3 and has some features as standard which are extra on the IBM PC.

● Unlike some rival IBMulators, the M-24 is backed by a large, well known multinational company with a wide range of computers and office equipment, and an established reputation for quality and service.

● The price will not be announced until the M-24 is launched, but Olivetti's aim is to undercut the IBM PC. This should make it excellent value.

SMITH-CORONA® TP-1™

DAISY WHEEL PRINTER – FOR THE COST OF A MATRIX PRINTER

THE IDEAL COMPANION FOR YOUR BBC AND A HOST OF OTHER COMPUTERS

Printer shown fitted with tractor feed – available at extra cost

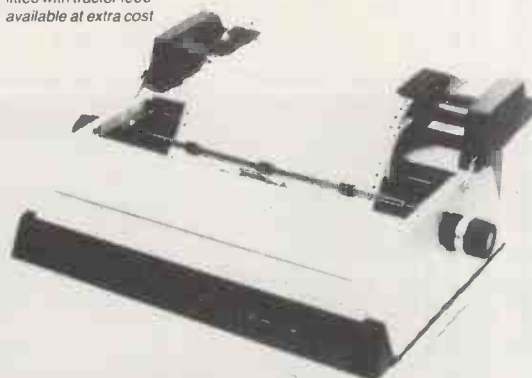

SPECIFICATIONS

Print Speed: 120 WPM
Character Set: 128 ASCII, 88 printable
Character Spacing (pitch): 10 CPI or 12 CPI
Printing: Unidirectional
Paper Width: 13" (33cm) max.
Writing Line: 10.5" (26.7 cm)
– 105 character line in 10 pitch
– 126 character line in 12 pitch
Line Spacing: 6 lines per inch
Paper Feed: Friction single sheet or fanfold
Paper Thickness: .022" paper thickness
Impression Control: Operator Selectable 5 level
Interface:
Parallel: 7 bit ASCII data, 3 control lines (Data Strobe, Busy, Acknowledge)
TTL compatible

Serial: EIA RS232C, 110 to 19,200 baud, strap selectable, character length and parity are strap selectable
Power Requirements:
240 V ± 10%
50HZ, 120W
Physical Dimensions:
6.4" (16.25cm) H
19.5" (49.5cm) W
12.4" (31.5cm) D
18 Slots (8.4 kg)
Environmental
Operating: 55° to 104° F 10 to 80% humidity (no condensation)

Storage: 40° to 160° F 5 to 95% humidity (no condensation)
Noise: 63-69 dBA
Operator Control: Power on/off; Top of Forms
Impression control
Printer Supplies
Printwheel
Life: 2 million characters
Wheel Composition: Nylon reinforced with glass
Configuration: 86 petals
Ribbon Cassettes
Types & Litter:
Film – 57,000 characters
Fabric – 250,000 characters
Multi-Strike – 250,000 characters
Top of Form: in TOF mode, the printer automatically advances the paper to the top of the next form after printing the 58th line or on recognition of ASCII Form Feed character

- Tractor feed available – £75.00 inc VAT
- Centronic® Converter for VIC 64 available – £45.00 inc VAT
- Available with Centronic® or RS232 interface
- Fully Guaranteed

ONLY £249 INC VAT (CARRIAGE FREE)

DAYTRON



Warwick House,
Forge Lane,
Minworth, Sutton Coldfield,
West Midlands B76 8AH.
Tel: 021-351 5959

Qty	Price inc VAT	Total
TP1 Centronic®	249.00	
TP1 RS232	249.00	
TP1 Tractor Feed	75.00	
VIC 64 Converter	45.00	
Total		



Please allow 10 days for delivery



Name.....
Address.....
.....
I enclose cheque payable to:
Daytron Ltd for £.....
Please charge my Access/Barclaycard
No.....
Signature.....

● Circle No. 260

Dyneer: Daisies with perfect characters



THE DYNEER DW16 – pictured above – offers Daisy-Wheel-Perfect print at a price you'll find difficult to believe.

With a print speed of 16 cps (Shannon Text at 14 cps), the DW16 features bi-directional printing up to 10 inches wide on 12 inch (max) paper, and offers a choice of tractor or friction feed systems.

If you need higher performance, the DW20 and DW36 offer maximum print speeds of 20 cps and 36 cps respectively, printing up to 13.2 inches wide on 17 inch (max) paper. Plus an

optional automatic cut-sheet feeder for users needing maximum correspondence throughput.

But whatever the print speed, every Dyneer Daisy is built to the most stringent engineering standards and is compatible with most popular word-processing packages. And all feature the Dyneer Hallmarks: Quality, Reliability and Unbeatable Price/Performance.

Ring us for details and you'll have to agree we're right. Printers of perfect characters – and at prices you'll hardly credit.

X-DATA

THE NAME BEHIND
THE PRODUCTS IN FRONT

X-DATA LIMITED, 750 DEAL AVENUE, SLOUGH TRADING ESTATE, SLOUGH, BERKS SL1 4SH. TEL: SLOUGH (0753) 72331

a **Dyneer** company

The Alphatronic



The Alphatronic Personal Computer makes playing, learning and working more fun, more fulfilling, more rewarding. But when you put it to work, then it really means business. In fact it's probably the cheapest way to access business programmes through CP/M software.

The games first though — enough for the most ardent player. Some just plug into a socket at the back, with their own 16K Rom module. Others can be played from virtually any cassette recorder. There are arcade games to sharpen reflexes and test imagination. Educational programmes to increase knowledge, plus chess and other traditional games.

You'll benefit from the learning programs. There are cassette instruction courses on writing programs in BASIC. Other cassettes get you and your family off to a flying start into skills like typing, household budgeting, tax returns and investment management. And of course there's our own

instruction and BASIC interpreter manual.

Now to business. The Alphatronic PC is unusual in giving you low-cost access to a complete version of CP/M, the world's most popular operating system for business software. You just connect up one or two floppy disc drives and a printer, then you can run a whole host of new management programs: office word processing, business accounting packages and financial planning — the choice is tremendous.

The keyboard is a real delight compared with competitive models. There are very few confusing multi-function keys, and a really professional numeric keypad is included. Six separate keys can be programmed and indexed for special routines. And the full alphanumeric keyboard is just like a modern electronic typewriter.

You may recognise the keyboard, because the

C means business

TA ALPHATRONIC PC



TA GAMES HARDWARE



TA EDUCATION HARDWARE



TA BUSINESS HARDWARE

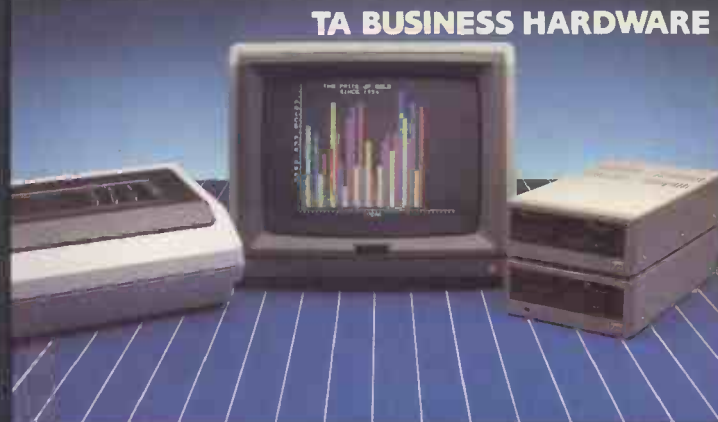

Alpatronic PC is from Triumph Adler, leading European manufacturers of business machines, who supply offices in 40 countries worldwide.

That means real commitment and continuity in design, engineering and software support. For instance, TA make sure you can get everything you'll need — ribbons, stationery, disks, upgrading peripherals — from just one source.

So you play and learn on the Alpatronic PC, and enjoy good value for money. Or you can really make it work for you. Then you'll really see what it's worth.

For you, your family and your business, get your hands on an Alpatronic PC now.

Please let me know where I can try the Alpatronic PC.

Name: _____

Address: _____

Telephone: _____

The logo for Triumph Adler, consisting of the letters 'TA' in a stylized, bold, red font.

TRIUMPH-ADLER

Triumph Adler (UK) Limited, 27 Goswell Road, London, EC1M 7AJ.
Telephone: 01-250 1717

● Circle No. 157

83

J5

WITH THE ADVENT of full 16-bit power, the emphasis in design is shifting increasingly on to making computers easier to use. The Lisa's mouse facility was one of the first manifestations of this trend. The physical movements of a mouse, mimicking those on screen, are supposed to provide a natural link between the human operator and machine operation.

But what interaction could be more natural than touch? It is this idea that lies at the heart of Hewlett-Packard's Series 100 HP 150 micro. You touch the screen to pick out one of the command options on offer, which is then initiated automatically.

Externally, the HP 150 bears more than a passing resemblance to the HP Series 200 Model 16, reviewed in last December's *PC*. Within the 12in. cube of the main unit is housed the 9in. CRT with its associated touch screen circuitry, the motherboard and the output ports.

The system for review included a swivel and-tilt base that allows the unit to sit neatly on the disc-drive box which houses two 3.5in. 265K microfloppies. The same configuration is used for the Model 16. The HP 150's detached keyboard has progressed beyond the rather dumpy functionalism of the earlier machine, and sports a dazzling array of facilities.

This entry system, which includes an 8088 running at 8MHz, 256K of RAM and 160K of ROM together with systems software and MS-DOS, costs £2,995 plus VAT. Winchester options start at £4,395 plus VAT for 5Mbyte. The HP 150 can also function as a standard HP terminal, with IBM terminal emulation promised for the future.

Double duty

The keyboard is detached, and connects via a standard coiled cord to a socket in the rear of the main unit. Apart from the usual QWERTY keys there are a multitude of special keys, many of which can be shifted to give further facilities. Keys on the numeric pad do double duty controlling the graphics cursor.

A hard reset or cold boot is initiated by Control, Shift and Break held down simultaneously. Pressing a key labelled Menu together with Shift and Control turns the touch screen on and off. Shifting the Cursor Home key, which is marked with a diagonal arrow, takes you to the bottom of the last page. There are also Previous and Next keys for paging back and forward through a text.

Above these are keys for inserting and deleting characters and lines. Insert Character toggles between character replacement and character insertion, which is signalled on one of the status lines at the bottom of the screen. A problem with this layout is that the Insert and Delete functions are close together. It is rather too easy to mistake one for the other, with dire results. In addition to the eight function keys above the main keyboard, which correspond to the touch screen labels, there

HEWLETT PACKARD MODEL 150

TOUCH-
SCREEN

Glyn Moody reports on HP's stab at the market for non-specialist office micros.

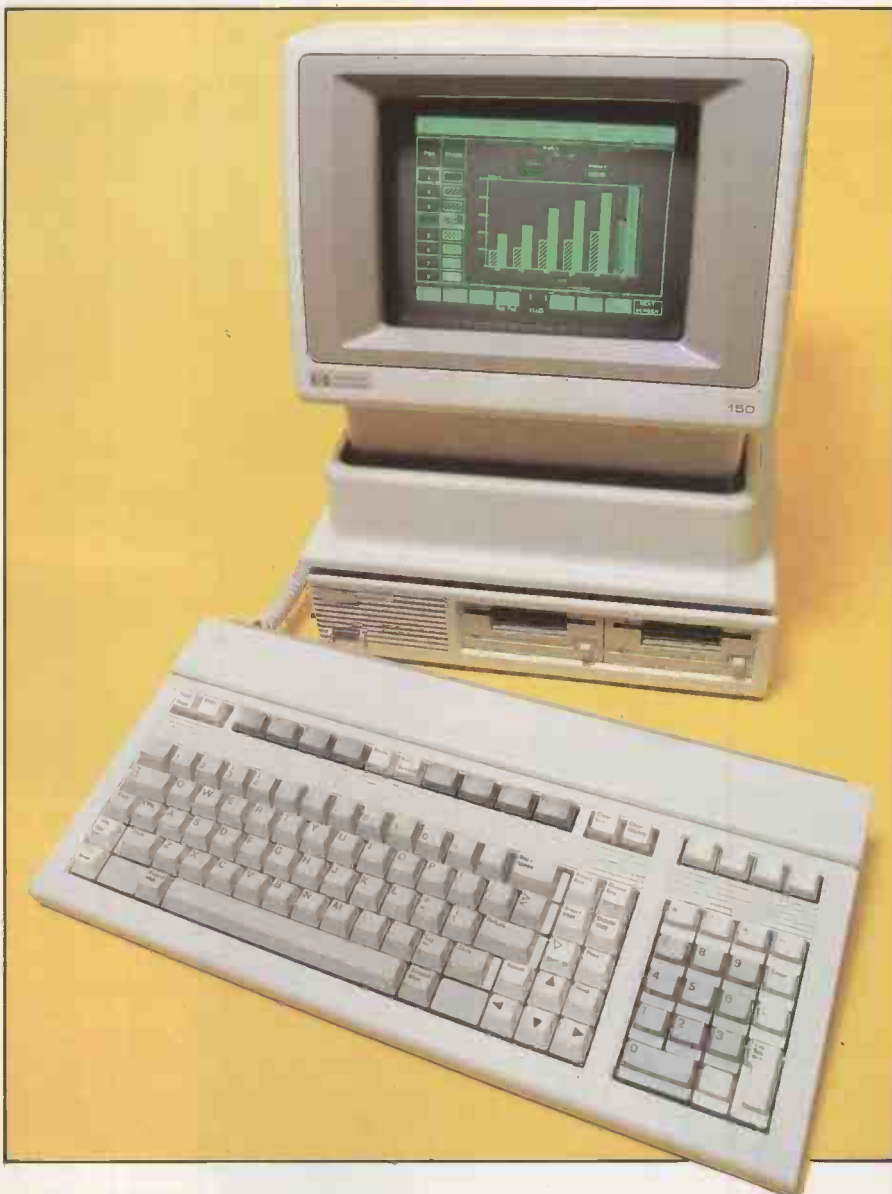

are a further four above the numeric pad.

The keyboard unit is solidly built and comes with the usual tilt-up stand at the back for angling the unit. The feel of the keys is slightly lighter than that of the IBM keyboard, but is entirely usable for fast touch-typing. Keystrokes and touches of the screen are signalled by a soft blip. A full U.K.-style keyboard was provided with the review machine, but the screen characters produced followed a basic IBM-type layout. Presumably final-release versions will have fully implemented U.K. characters.

Clear display

The 9in. green phosphor screen normally displays 80 characters per line. For its small size it displays text surprisingly clearly. The video circuitry has been engineered to allow the individual dots that make up each character to be shifted by up to half a dot and enlarged by up to one-third. Each character can therefore be made much more legible than conventional dot-matrix characters.

Compared with the excitements of the

touch screen and keyboard, the rest of the system is a model of restraint. As on the earlier Model 16, the motherboard is packed tidily away underneath the CRT and its associated video circuitry.

Beneath the main chips there is space for two plug-in expansion boards. Both these and the motherboard simply slot into large edge connectors at the back of their respective compartments. Plug-in accessories currently available include an expansion memory board taking RAM up to 640K. Hewlett-Packard intends the 150 to be an open system in terms of development, and is encouraging third-party add-ons.

On the back edge of the motherboard are two RS-232 ports and HP's own implementation of the standard IEEE bus known as the Hewlett-Packard Interface Bus. The HP-IB is used for printers and disc drives. Several units can be daisy-chained off the port by successive piggybacks. To avoid problems of poor connections that often bedevil such arrangements, HP has devised a hardy plug that is screwed into the port itself or into any other plugs already connected.

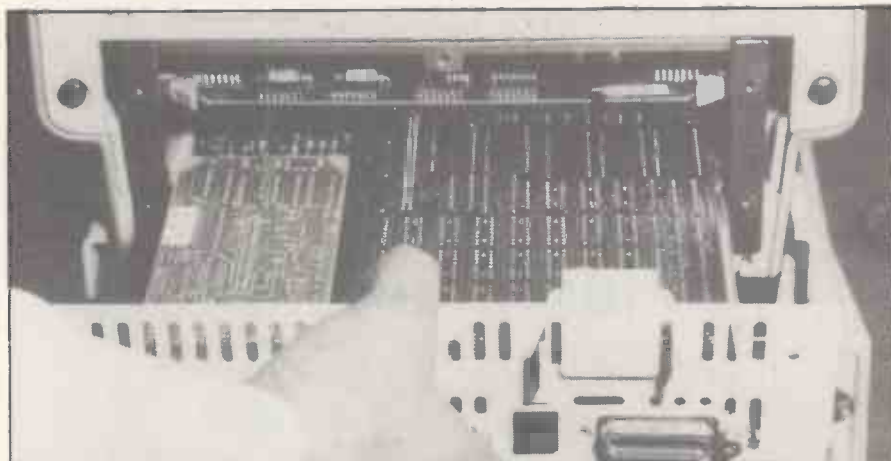

The motherboard slots neatly into the back of the machine to rest under the CRT.

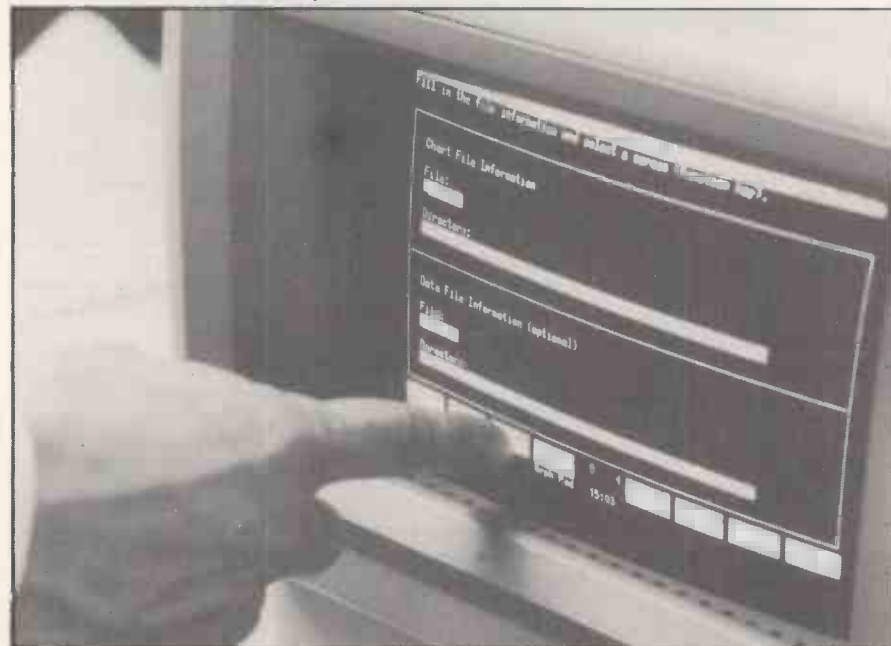

Touching the screen breaks the infrared beams emitted from its edges.

As an alternative to using the HP-IB and an external printer, it is possible to install a small thermal printer that perches in a cavity above the CRT of the main unit. In this way, even more is packed into what is already a very compact system. The price you pay for having processor, CRT and printer all in one box is loss of portability. Even without the printer the unit weighs 20lb.

The review system included a dual disc-drive unit using 3.5in. microfloppies, each with a formatted capacity of 265K. The rotation speed is 600rpm, rather than the more usual 300rpm. In addition to the short, stout HP-IB cable there is an interconnect power cable between the disc drive and the main unit, doing away with additional mains leads snaking over the floor. The disc unit provides a convenient base for the monitor mounted on its tilt-and-swivel base. Configured in this way, the whole system is only about 16in. high.

Applications software available on the HP 150 runs under MS-DOS. The touch screen would hardly represent a great leap forward if its net result were only to allow MS-DOS commands to be initiated from the screen by pointing, rather than from the keyboard via keystrokes. An outer shell is required to insulate non-technical users from the messy details of the operating system. HP's solution on the 150 has been dubbed Pam — Personal Applications Manager. It allows basic MS-DOS operations like formatting and copying to be initiated and provides a simple and uniform way of calling up applications software.

Before software can be used with Pam it must be copied on to a disc and linked into Pam. Security copies of program discs can be made only by means of the Install program. The standard Copy routine can be used for data discs.

Security copies

Programs must be installed on formatted discs. Using Pam and the Format program supplied on the operating system disc, formatting requires only three touch screen commands. When you boot up the system with the main Pam disc in one drive, and the disc to be formatted in the other, you are presented with the command options along the bottom of the screen. In the centre of the screen there are the various applications programs that have been installed and are thus available using Pam.

When you touch the block marked Format it is immediately highlighted, indicating that it is now the selected program. You touch the command block Start Applic to load and run it. The following screen is used to select the disc to be formatted, and also to give it a disc label. At this point it is also possible to copy MS-DOS and Pam on to the newly formatted disc. Both use a lot of space, and so with some applications there is just not enough room on a single disc.

(continued on next page)

(continued from previous page)

An applications package can now be installed on the formatted disc. First a further systems disc containing the program Install is placed in drive A. Pam is made aware of its existence by touching the command block Reread Discs. Install then appears on the main screen area as an installed program.

After selecting it by touch, the Start Applic command is invoked and the program run. A screen follows that asks for source and destination drives. Both are chosen by touching the appropriate letters. Finally the master disc is placed in drive A and Reread Discs pressed again. You have to do this whenever discs are changed in the course of a session, rather like using Control-C commands in CP/M.

A command Show Applics lists the available source programs in drive A. After selecting one of them, Start Install is used to begin the process of transfer and installation.

Complex sequence

Installing an application is probably the most complex sequence of operations required in using the HP 150, though it is something you are likely to have to do only once or twice. By and large Pam has successfully replaced strings of obscure MS-DOS commands by screen options, in English, activated by touch. The only drawback is that several operations, albeit simple ones, are required to do what MS-DOS does with a single command.

The microfloppy discs are convenient to use, but their storage capacity is smaller than 5.25in. floppies, which can be a

serious drawback at times. Both Pam and MS-DOS are hungry for space, and may not leave enough room for an applications program as well. The repeated disc swapping which is then required soon becomes tiresome. Perhaps the next generation of microfloppies will be roomy enough to make them viable — and there is always the Winchester option available, if you have the money.

Integration of an application package into Pam allows it to access an important facility called File Manager. At certain points in a program's command tree — for instance when a file is being saved or retrieved — File Manager may be displayed as one of the touch screen options. Selecting it calls up the directory for the current disc.

In many ways File Manager provides an extended Dir option, as found in MS-DOS, but without the opaqueness of that command. Files are selected, as usual, simply by touch. Directories and sub-directories may also be changed.

Applications software available on the HP 150 includes old faithfuls like VisiCalc and WordStar, plus some new programs written by HP. The implementation of VisiCalc is straightforward: the main command and editing options are displayed on screen as touch blocks at the bottom through which you reach further menus. A similar tree structure forms the basis for the integration of the touch screen into all the programs. Cells on the spreadsheet can be selected simply by pointing at them,

otherwise there is a certain amount of hopping between touch commands and straight keyboard input.

The same is true of the word-processing program supplied for review. Not content with supporting WordStar, HP has come up with its own home-grown version called Memomaker. HP claims that text files may be exchanged freely between the two packages.

As its name suggests, Memomaker is aimed at the executive jotting down a quick memo rather than a secretary who has to produce a polished final document. By sacrificing some of WordStar's very powerful but rather involved features, HP has come up with a word-processing program that is easy to use. The system is largely WYSIWYG — what you see is what you get — with bold text appearing in highlighted characters and underlined words in a rather dainty italic.

Move by pointing

The command labels at the bottom of the screen lead to further menus for filing, block commands, formatting and printing. The touch screen is used to select various options and to set up parameters within those commands. For example, blocks are defined by the position of the cursor, which can be moved at will simply by pointing. Right- and left-hand margins can similarly be set.

This ability to position the cursor just by pointing to the appropriate place on the

Specification

CPU: Intel 8088, running at 8MHz

RAM: 256K expandable to 640K

ROM: 64K

Size: 295mm. wide by 300mm. high by 315mm. deep

Display: monochrome 9in. allowing 80 columns by 25 lines; characters formed on a 14-by-9 matrix; dots can be shifted by up to half a dot and enlarged by up to a third

Keyboard: detachable; 12 function keys; numeric/graphical pad

Interfaces: two RS-232, one HPIB

Discs: one or two 3.5in. microfloppies; formatted capacity 265K; hard discs of 5 Mbyte and 15Mbyte available

Software in price: MS-DOS and systems software including Pam

Hardware options: expansion boards for RAM, internal printer

U.K. prices: standard system as reviewed with dual microfloppies, £2,995; single microfloppy with 5Mbyte Winchester, £4,395; 15Mbyte Winchester system £4,995; internal thermal printer, £380; all prices subject to VAT

U.K. distributor: Hewlett-Packard Ltd, Personal Technical Computers, Eskdale Road, Winnersh, Wokingham, Berkshire RG11 5DZ. Telephone: Crowthorne (0344) 773100

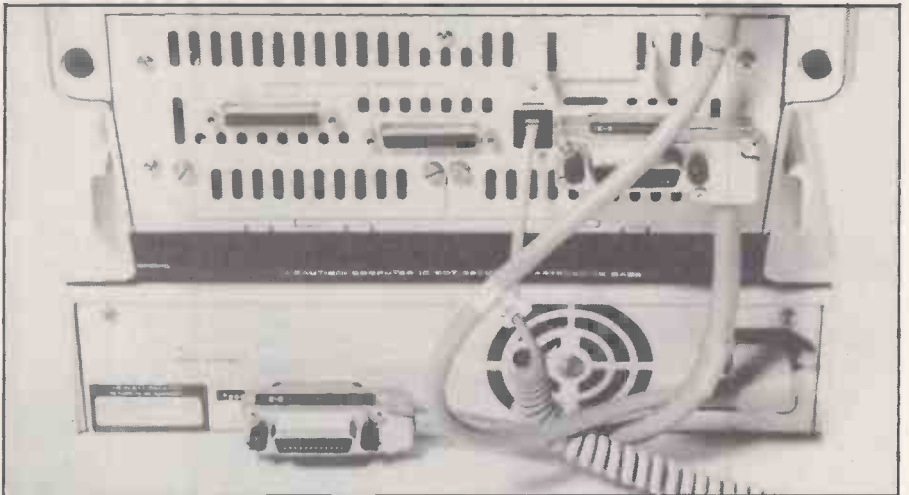

On the back edge of the motherboard are two RS-232 ports and the HPIB.

Benchmarks

The benchmarks were run using Microsoft Basic version 5.28. Although no use is made of the touch screen in standard Basic, it is possible to write routines implementing it in any Basic program. The figures obtained for the eight standard routines — details of which were given on page 103 of the January issue of *Practical Computing* — make the HP 150 the fastest 8088-based machine we have tested.

	BM1	BM2	BM3	BM4	BM5	BM6	BM7	BM8	Av.
HP 150—8088	1.1	4.0	8.7	8.8	9.9	18.5	28.0	27.0	13.3
HP Series 200	0.2	0.6	1.4	1.6	1.7	2.8	4.3	15.0	3.5
Model 16—68000									
IBM PC—8088	1.2	4.8	11.7	12.2	13.4	23.3	37.4	30.0	16.8

screen is most useful when correcting and altering text. Even with the most sophisticated word processor, the process of finding and changing text is usually one of the slowest operations. With the HP 150's touch facility, single letters can be located and replaced almost instantly.

Text does not automatically re-form after insertions or deletions; you have to use the block command to realign any modified paragraphs. Another idiosyncrasy of the program is a very slow output of characters from the keyboard buffer and it is possible to race on ahead of the displayed text, though no irreparable damage seems to be done. Apart from such quirks, all the main word-processing functions are there, and readily accessible to the non-expert via the touch screen.

Problems

Using the touch screen can be a problem when text fills the entire screen. When you are trying to position the cursor under bottom-row words it is all too easy to select one of the command at the foot of the screen options by mistake.

HP has chosen to implement the upward movement through the command trees by the right-most touch label. This is fine, except that the final Exit Memomaker command is also located here. One finger stab too many, and you are out in Pam. Though getting back is simple enough using the touch screen commands you have to go through each of Pam's various functions, and it all takes some time.

Other aspects of Pam's power are demonstrated in HP's suite of graphical programs. Partly because of their impressive range of features, these are big programs of over 200K. As a result there is no room for the operating system to be installed on the disc with the applications. The installation process itself takes over two minutes. I actually aborted several attempts, convinced that the manic clattering of the two discs indicated errors not eventual success. Perhaps the documentation should give an indication of the time required.

HP offers pie, line, bar and text charts in the series, all operating on similar lines. Data for time charts is entered on a spreadsheet-type screen with one column for each line graph. Each row corresponds to different points along the x-axis: you could enter different values for successive months, for example. HP claims that data can be transferred directly from VisiCalc and other similar packages.

When the data has been entered you touch the Preview command label at the bottom of the screen. A miniature version of the final graph is then produced, complete with reduced-size captions. Main titles, subtitles, axis labels and footnotes can all be added at this stage.

The title to be altered is selected by touching it — one of the neatest and most impressive uses of the whole touch screen concept. Not only does this select a screen position but the routines appropriate to that position are invoked without any further commands from the operator.

A more general Annotate feature can also be called from the touch screen. A fine cross-wire graphics cursor then appears, which you control from keys on the numeric pad. Annotations can be fixed at any point on the graph simply by positioning the cross wire and keying in the required text.

When the graph has been annotated and labelled, a final full-size print can be obtained. The Plot function allows you to choose the position of the chart on a page, paper size, the medium on which it is drawn and the orientation.

Similar design

The pie chart and bar chart programs are similar in design. The Text Charts program offers a wide range of founts and type sizes for enhanced memos or simple artwork designs. For each line of entered text you can set four parameters to specify whether text is justified, the fount used, the pen number in the plotter and the size of the type.

The applications packages are all complemented by exemplary manuals written in a style that is easy on the mind without being condescending. They contain numerous screen illustrations explaining the chain of touch screen commands. There are numerous reference sections, and even indexes.

Conclusions

- The HP 150 is an exciting and innovative product. The touch screen is a real advance in user-friendliness.

- Although Hewlett-Packard is claiming that this system is suitable for almost any application, the price of about £3,000 for a usable configuration means that only business or professional users will be able to afford it. The whole approach seems best suited to these groups anyway: executives could find finger-pointing on a micro a natural extension of their daily management activities.

- The microfloppies are very convenient physically but have a rather too limited storage capacity.

- The compact vertical format makes the HP 150 ideal for desk-top use. Its weight and modular design make it less suitable for moving around.

- The 9in. screen is outstandingly clear considering its size.

- The choice of MS-DOS should ensure that plenty of software is available. HP is also to be congratulated for having published details of the touch screen system routines for use by software houses and end-users.

- The lack of a Centronics port means that standard parallel printers cannot be used. Serial printers may still be run off the RS-232 port provided.

- The HP 150 promises to be the first in a series of truly personal computers built around the touch screen.

The HP touch screen

The touch screen facility is provided by a series of 21 light-emitting diodes ranged along one horizontal edge of the screen and 14 up one of the sides. There are corresponding rows of detectors facing them. Touching the screen therefore breaks two beams and allows the position to be determined rather like co-ordinates on a grid: so many units along, so many up. This position can then be compared with the map of the screen held in memory. A command displayed on the screen at this point can then be implemented. Normally the bottom lines of the display are reserved for eight user-definable command options.

The touch-sensitive sections of the display correspond directly to eight main function keys on the keyboard, so it is possible to replace screen touches by simple keystrokes. Hewlett-Packard seems to have made this a general principle in software using the touch screen. If you end up considering the touch screen more a fad than an ergonomic breakthrough you can still use the good old-fashioned keyboard.

It is not necessary to touch the screen as the beams are broken if a pointer comes within about half a centimetre. But it is probably more satisfying to make contact than to prod around in empty space. There is no auto-repeat, so once a command is activated a finger left on the screen too long will not cause a further chain of actions.

To be detected, pointers must be at least as thick as a pencil. If two adjacent beams are broken the position is taken as midway between the two. This effectively doubles the resolution to around 40 by 28. In practice you can achieve single-letter accuracy in normal word-processing applications. Simultaneously breaking separated beams activates only one of them.

The touch screen has its own Intel 8041 processor. This eight-bit device comes complete with 64 bytes of RAM and 1K ROM as well as a timer and an I/O system. The same chip also handles all the keyboard input.

Extra commands

Neville Maude looks at Computer Concepts' Graphics ROM for the BBC Micro.

THERE ARE many sideways ROMs available for the BBC Micro — so many that soon we will start reading complaints that even with an extension board only 16 ROMs can be fitted. Computer Concepts' graphics ROM differs from others in that it augments the Basic instead of replacing it on command. It adds about 30 extra commands covering three areas: general graphics including a mode 8, sprites and turtle.

Commands

There are several general graphics commands. For example

*Circle 100,100,50

will draw a circle at 100,000 with a radius of 50. This sort of syntax is typical. The command *Pattern enables multi-sized circles, spirographs or patterns to be drawn on the screen in a variety of colours. Once initiated the *Rotate command turns all subsequent plotting commands round any specific point.

The BBC Micro's Basic has a good fill for triangles, but the *Fill command works with any enclosed shape in graphic modes. The command *Scale allows a graphic display to be made smaller or larger, *Arc draws arcs, and with *Plot you can achieve three-dimensional perspective plotting.

The general command *GFX,n provides information about graphic routines. Unlike the *Data command it stores results in the resident integer variables A% to E% for use in Basic programs. The useful *Help Graphics command lists all the other available commands.

Mode 8 augments the BBC Micro's seven modes. It is a 16-colour text and graphics mode rather like mode 2, but it uses only 10K of memory instead of the 20K needed by mode 2. Horizontal resolution is 10 by 32 characters or 80 by 256 graphics, which is half that of mode 2.

Soft sprites

Some computers have built-in hardware for sprites, which provides faster movement with less flicker, but the software method is more flexible and offers more options. The BBC Micro does have a facility for user-defined monochrome characters on an eight by eight matrix but the Graphics ROM's sprites can contain any number of colours and be up to three

characters across. It also permits up to 32 sprites of any size to be defined at a time and displayed anywhere on the screen or stored in memory.

The command *Film allows up to 47 sprites to be run in sequence in order to achieve animation, either moving about on the screen or in the same place. You can allot numbers to the sprites or to the Film commands and then use the numbers to control them. For example,

*OUT 4

would remove sprite 4 or film 4, and

*IMAGE 7,100,100

would put a copy of sprite 7 at the required location.

Commands and syntax

Help Graphics
Data (ID)
Film (ID) (anm)
Reset (ID) (to ID)
Get (fsp)
Out (ID)
Turtle (OP) (Xs, Ys) (col)
Penup
Left (angle)
Forward (dist)
Scale (X, Y) (X, Y)
Pixel (X, Y) (Xs, Ys)
Circle (X, Y) (radius)
Arc (op) (X, Y) (Xs, Ys) (stt, end)
Plot (op), (X, Y, Z)
Reserve (adr) (end adr)
Design (ID) (Xs) (Ys)
Alter (ID) (to ID)
Put (fsp) (ID) (to ID)
In (ID) (X, Y) (frame)
Image (ID) (X, Y)
Pos (X, Y) (angle)
Pendown
Right (angle)
Backward (dist)
Rotate (angle) (X, Y)
Print (str) (X, Y) (Xs, Ys)
Pattern (op) (X, Y) (Xs, Ys) (step)
Fill (X, Y) (col)
GFX (fn) (arg) (arg)

All commands are preceded by *

This list does not differentiate between non-optional arguments and those with default values.

The Logo language is a great favourite in schools, mainly for controlling turtles by very simple commands. Since many BBC Micros are used for educational purposes, the Logo turtle provided by Computer Concepts' ROM will be most welcome.

It does take a little time to learn to use all the new facilities to the full but in practice I only found one small problem. The Graphics ROM uses &C00 to &CFF as a workspace. Normally this space is reserved for definable characters, but some programs use it illegally. Loading then becomes impossible, or screen characters assume strange shapes. This is easily cured by the command

*FX 240,128

which cuts out the ROM. The command

*FX 240

will restore the ROM, as will a cold start. Alternatively,

*GFX 5

moves Page to allow room for user-definable characters while still permitting the use of the graphics commands.

Modification

After a period of use the only improvement I could think of was that it would be better for the ROM to be enabled on command instead of having to be disabled when not required. On ringing Computer Concepts to discuss this, the people I spoke to agreed with me and said they had already changed the design accordingly. On the latest models coming on the market you type

*FX162

to enable the ROM and

*FX 162, 128

to disable it.

Conclusions

• The Computer Concepts graphics extension ROM contains commands which should have been built into the computer in the beginning, plus others no one could have thought of at the time. It can be heartily recommended.

• It comes with a commendably clear and helpful instruction booklet.

• The ROM is supplied by Computer Concepts, 16 Wayside, Chipperfield, Hertfordshire WD4 9JJ. It costs £28 plus VAT and £1 p&p.



Mode 8 offers 16 colours and occupies only 10K.



The *Pattern command can be used for circular designs.



For programs using memory in the area &C00 to &CFF the graphics ROM must be switched out.

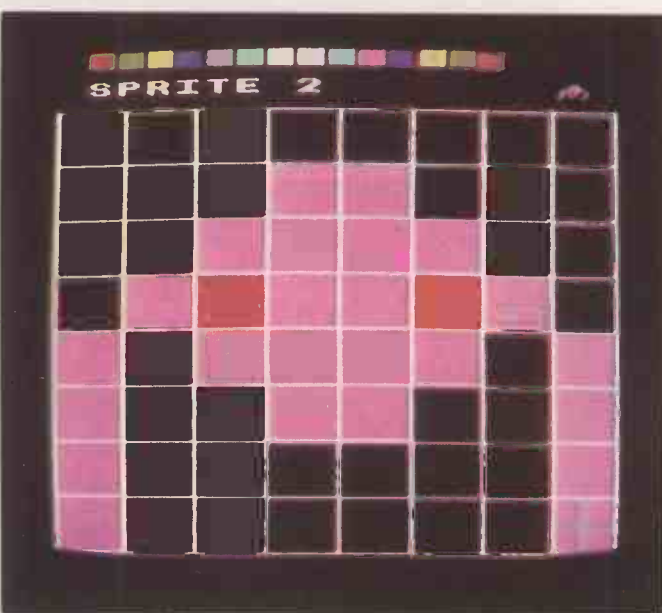
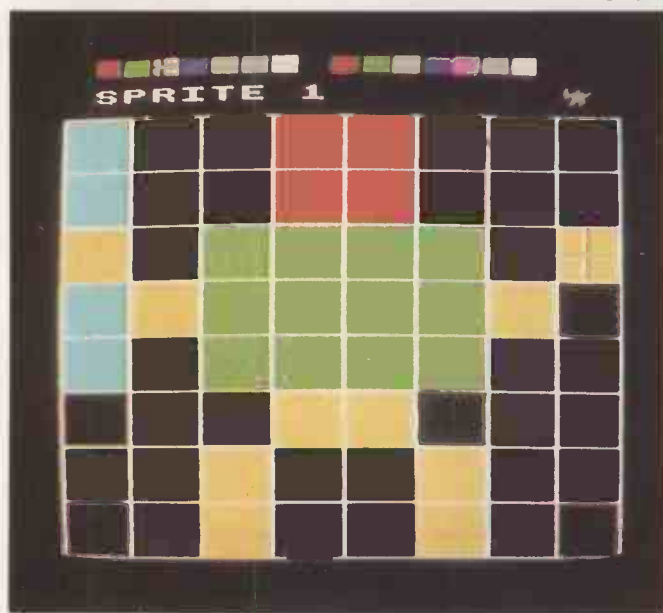

Multi-coloured sprites are constructed on an eight by eight matrix; up to 32 sprites can be stored.

AT £5,195 for an object weighing 10lb. the Grid Compass is an expensive device. But in its first year on the American market this mains-powered transportable has sold well. The system has even had various adventures; Grid Compasses have gone up in NASA's Shuttle, and gone into Grenada with the U.S. military. It is now officially available in the U.K.

However, Grid Systems Corporation is offering more than snob appeal. To justify the price, the Grid offers technology more sophisticated than that of the competition, leading to a more compact and convenient system for the user. The Grid has a flat electroluminescent display which folds down over the keyboard for transport, and it uses bubble memory instead of built-in disc drives.

The high price tag is also not too surprising when you examine the Grid closely. It is a striking machine. Packed up for travelling it appears to be a very flat black metal box about the size of a foolscap document wallet packed full. The measurements are 15in. by 12.5in. by 2in. The casing material is a hard magnesium alloy and the machine seems very well made. When you pick it up it is heavier than it looks, but at 10lb. it is neither too heavy nor too bulky to fit in a large briefcase.

The lid pulls up to reveal itself as a screen. Another flap pulls down at the back of the Grid to tilt the keyboard to a comfortable typing angle. At the back of

GRID COMPASS

Ian Stobie tests the transportable bubble-memory micro that was sent up into space.

the machine is the mains power socket and a full set of interfaces for printer, communications, system expansion and modem.

As soon as you turn the system on the orange display panel lights up showing the Grid logo and a flickering icon which indicates that the operating system is being

loaded from bubble memory. Transferring at 12.5K per second the Grid operating system takes a few seconds to load, giving you ample time to examine the flat-panel display screen and keyboard.

Bubble memory retains its contents when the power is turned off, so it can be used like a floppy disc for storing data and programs. Having no mechanical moving parts it is more robust than a conventional disc drive and is lighter. But it is expensive, and no faster than a floppy disc.

The Grid electroluminescent display looks very different to the familiar black on



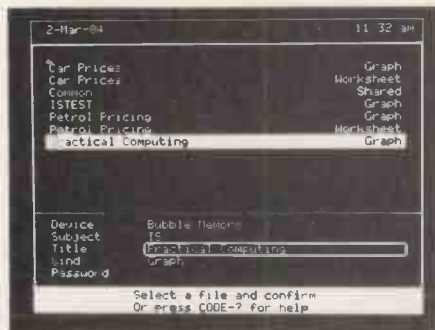

Grid software uses menus and fill-in forms to interact with the user.

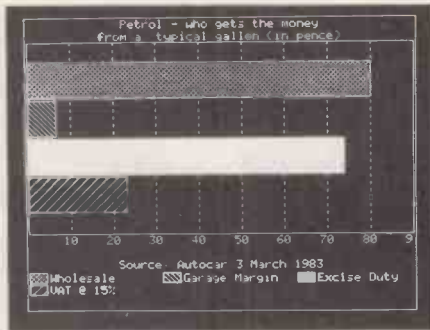

The Grid display is very stable and can show graphics as well as text.

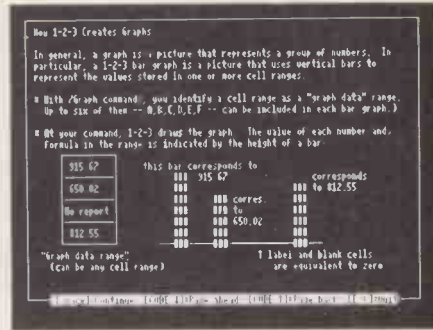

Lotus 1-2-3 running on the Grid, displaying 80-column text across the 6in. screen.

white calculator-style liquid-crystal display because it glows with its own light. But unlike a TV-style cathode-ray tube each dot is fixed in place, so the image is very stable. The Grid screen is covered with a matrix of 320 by 240 dots. The screen surface is warm to the touch and when close to it you can hear a quiet hum, but neither effect is disturbing.

The screen is bright, and the brightness cannot be adjusted, but I found it perfectly relaxing to use. Both text and graphics are fully supported. Up to 24 text lines of 80 characters can be shown on the screen but unless you override it the system usually uses a larger 53-character-per-line font which is more readable.

The Grid keyboard is full size and feels very solid. With each key depression it sounds two clicks, as does the IBM PC keyboard. It has no function keys but in addition to Shift and Control there is an extra Code shift. The two Code keys, located either side of the space bar, are used with different letters to initiate different actions. Initially I found it easy to confuse the Code and Shift keys.

Once the operating system has booted, the screen displays a form. You select the option you want by moving a gold bar to it with the cursor-control keys, and then confirm your selection by holding down the Code and Return keys.

The review system also included the optional 5.25in. floppy-disc drive since we wanted to test out MS-DOS and see how IBM compatible the system is in practice. Obviously several Grid users at a particular site could share a disc drive, connecting up only to download software into bubble memory. The company offers a full-scale local area network called Grid Server. This allows up to 44 Grids to share up to 15 different peripheral devices at a time. The price of a typical Grid Server system with 40Mbyte hard disc is £22,000.

Grid Central provides a similar service more cheaply. It can be thought of as a kind of extended area network, connecting Grids up to a central resource centre via the telephone network. Our review system contained a U.S. Bell system compatible auto-dial modem, which is not approved for U.K. use. The U.K. version will add £800 to the cost of the Grid and is currently undergoing the BT approval process. The modem you need to use Grid Central can

(continued on next page)

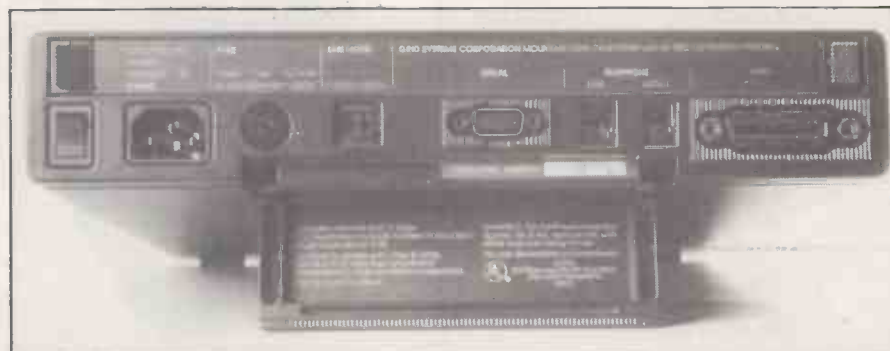

RS-232C, RS-422 and GPIB interfaces are provided; the modem is awaiting BT approval.

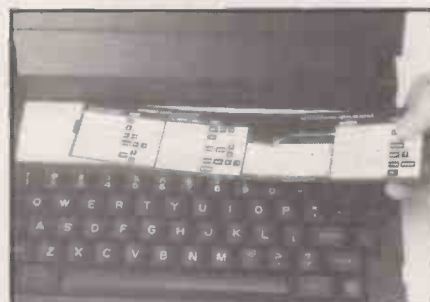

Control-key assignments are explained on cards which slot in above the keyboard.

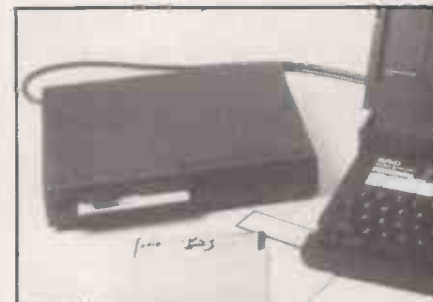

Floppies are available to supplement the 384K built-in bubble memory.

Specification

CPU: 16-bit Intel 8086 processor with 8087 arithmetic co-processor fitted as standard
Memory: 256K RAM expandable to 512K; 16K ROM with 384K of bubble memory
Display: 6in. diagonal, flat, amber display panel, uses electroluminescent display technology; shows 320- by 240-dot graphics and 24-line by 80-column text; type size is user-defined, with selectable 64-column and 53-column text widths
Keyboard: full-size QWERTY layout keyboard with 57 keys
Discs: built-in 384K of bubble memory, used like disc drive for data and program storage; additional 360K 5.25in. floppy-disc drive costs £2,050; hard-disc options also available
Modem: auto-dial direct-connect modem, price £800, is intended as built-in Grid feature but not yet BT approved for U.K. use; once approved will enable the Grid to use Grid Central service
Interfaces: RS-232C and RS-422 high-speed serial printer and communications ports; IEEE-488 general-purpose interface bus, GPIB

Portability: weighs 4.5kg. (10lb.) mains-powered; screen folds down over keyboard forming a flat 380mm. (15in.) by 320mm. (12.5in.) package, 50mm. (2in.) high; magnesium alloy case claimed to withstand knocks of 135G; comes with fabric carrying case; optional rechargeable battery unit will sustain one hour of continuous use but increases weight to 6.4kg. (14lb.)
U.K. price: £5,195 without modem
Software: Grid OS and management tools, which include Gridwrite, Gridplot, Gridfile and Gridplan integrated word processing, graphics, record keeping and spreadsheet packages, costs £785; Microsoft MS-DOS costs £135 supplied on disc; Grid-supported packages offered under MS-DOS include Lotus 1-2-3, Multiplan, WordStar, dBase II and TK!Solver; TTY, DEC and IBM terminal-emulation software and Pascal, Fortran and Basic languages are available under Grid OS
Manufacturer: Grid Systems Corporation; made in U.S.
U.K. distributor: Thame Systems Ltd, Thame Park Road, Thame, Oxfordshire OX9 3XD. Telephone: (084421) 5471

GRID COMPASS

(continued from previous page)

also be used for other purposes such as dialling up commercial databases and accessing electronic mail systems.

According to Grid Systems, in the U.S. for roughly \$100 per year you can store up to 500K on monster disc drives kept at Grid Central's Mountain View location in California. This means you can keep both data and copies of programs you are not currently using on disc and then transfer them via the phone system into the bubble memory of your own Grid machine when needed.

Buying software from Grid Systems involves moving a copy across to your Grid Central disc file. Transferring data down a phone line at the built-in modem's top speed of 1,200 baud means programs load at approximately the speed of a home-computer cassette. The process is not very convenient but does free you from having to take a disc drive around with you.

Phone charges

Grid Systems says that the likely U.K. price for the Grid Central Service is £100 per 500K, to which must be added the telephone call charges, which will be to a London number. Grid Systems expects to launch the service towards the end of this year. For the time being the £1,050 disc drive is essential if you want to buy commercial software.

The Grid disc drive connects into the IEEE-488 at the back of the machine, which can be used piggyback fashion so that several devices can be plugged in. To boot the MS-DOS 2.0 disc you turn off the Grid — there is no Reset button — and turn it back on with the F button held down. MS-DOS appeared to work satisfactorily on the review system. The Lotus 1-2-3 tutorial disc Grid Systems supplied us with also worked well.

From our collection of IBM PC discs we tried out a range of different products. We had no trouble getting simple text files in or out. Anything more complex, Multiplan for example, has to be correctly installed for the Grid. IBM programs such as Microsoft Flight Simulator, which go below MS-DOS to the IBM's ROM routines, loaded but then blew up.

So the Grid machine is file compatible with the IBM PC and can read MS-DOS files off IBM-format 5.25in. floppies, but it is not operationally or functionally equivalent to the IBM PC. Consequently most business data generated by MS-DOS programs running on the IBM will be available to the Grid user. On the other hand, programs will generally have to be



With the screen folded down the Grid packs neatly into its carrying case.

bought specifically for the Grid from the range available from the Grid Systems.

Among the things we tried to load from our IBM discs were various Basic interpreters, but they did not run. Grid Systems had not supplied us with a Basic for the review machine so we could not establish Benchmark timings. The Grid comes fitted as standard with the Intel 8087 arithmetic co-processor which can speed up program execution times very significantly.

The Grid Basic which runs under Grid OS fully supports the graphics and other hardware features of the Grid, but it is not quick. It is a compiled Basic, which is not ideal for the non-technical business user, so Grid Systems tends to recommend Microsoft's Basic interpreter running under MS-DOS to most users. But according to Grid Systems, Grid Fortran and Pascal make full use of the 8087 co-processor and are fast.

Grid Systems software covers the now standard set of general office tasks. The set of integrated management tools including word processor, spreadsheet, business graphics and database cost £785 and are bundled together with Grid OS. All the packages work in the same way and are discussed further in the feature on integrated software on page 132 of this issue.

The Grid applications are simple to use. You have overlay cards to help you remember the commands, menus and forms displayed on the screen, and a Help screen is usually available if you push Code-?. I found it was not necessary to look in the manuals, which given their large size and hefty weight is just as well with a system that aspires to be transportable.

The manuals are of a high standard, very

comprehensive and full of screen dumps showing you what should be happening on your system. A tutorial program comes with the system in bubble memory, and links to a self-teach tutorial manual which introduces the system in simple terms to the user.

Professionals who perform analysis of some kind or make presentations on a regular basis at a client's office, auditors, accountants, insurance agents, salesmen and the like, are probably the sort of people who can best make use of the Grid. Field personnel who collect data or go through diagnostic checklists, in maintenance or surveying roles, for instance, may also be interested.

Battery pack

Though the Grid is basically a mains-powered machine an optional battery pack is available for £350. It adds about 4lb. to the weight of the Grid and provides about an hour of continuous use, but it can be recharged from a 12V car supply. Bubble memory retains its contents even when the battery is flat.

Computers are unusual compared to other commodities in that this year's expensive Rolls-Royce machine may be very close to what the ordinary user will have in a year or two. For some potential users the cost of the Grid Compass justifies buying it now. For the rest of us it is interesting to ponder what will happen as the technology it employs gets cheaper. It is probably the shape of things to come for every office user.

Conclusions

- Compact, stylish, robust and expensive, the Grid Compass will appeal to those who regularly need to work away from their own office with a computer to hand.

- The flat-panel display, with its unusual electroluminescent technology, is clear and stable and shows a full-size 80 by 24 text display and good graphics.

- Although the bubble memory works well, until BT approve the Grid built-in modem most users will also need to buy a steeply priced Grid floppy-disc drive.

- The Grid Central concept of renting disc storage which is then accessed via the phone system has advantages to anyone interested in portable computing. The proposed charges seem very reasonable but the availability of the service depends on BT as well as Grid Systems.

- Grid Systems' range of fully integrated software performs all the common office tasks well, is easy to use and genuinely data and command integrated. A full range of good-quality MS-DOS software is available for the system too.

- The Grid is best described as IBM PC file compatible rather than fully compatible, which means most data should transfer on disc, but not all existing PC application software.

KGB

THE PRICEBREAKERS!

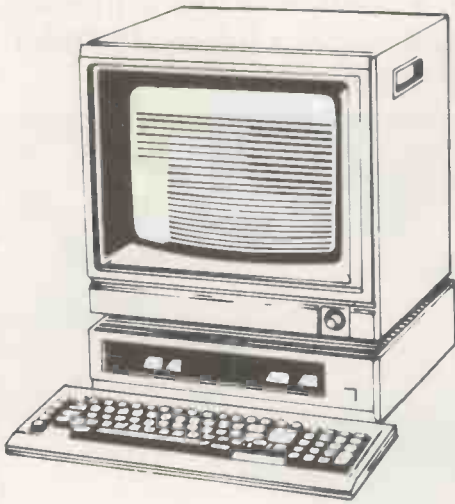

NEW **SANYO**
MBC 550
 16 Bit 128K RAM 1 x 160K Floppy, Screen, **£825.00**
 MS DOS, Wordstar, Calcstar, Basic (EX-VAT)

NEW **MBC 555**
 16 Bit 128K RAM 2 x 160K Floppies,
 Screen, MS DOS, Wordstar, Calcstar, **£1025.00**
 Infostar, Basic, Spellstar (EX-VAT)

SIRIUS
Sirius 1
 16 Bit 128K RAM 2 x 600K
 Floppies, MS DOS, Graphics,
 Screen, Basic **£2195.00**
 (EX-VAT)

SX
 as Sirius 1 but with superb
 10MB Winchester and
 1 x 1.2MB Floppy **£3995.00**
 (EX-VAT)

**CALL FOR KGB'S SPECIAL
 SUMMER OFFERS!**

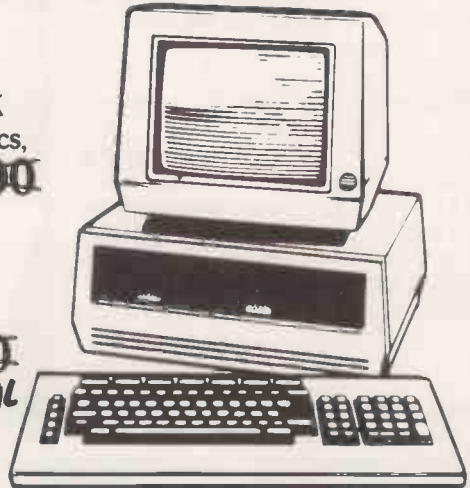

APRICOT **CALL FOR KGB'S SPECIAL
 SUMMER OFFERS!**
Standard
 Full 16 Bit 8086 based Micro with 256K RAM, Mono
 Screen, 2 x 315K Floppies, MS DOS, **£1890.00**
 Supercalc, Basic, Superplanner (EX-VAT)

NEW Xi as standard Apricot but with 5MB **£2695.00**
 Winchester in place of one Floppy Drive (EX-VAT)
 with 10MB Winchester **£2995.00**
 (EX-VAT)

Join the **KGB Computer Club** free! Receive advance details of all new products and special offers plus informative KGB Newsletter.

KGB 106 St Leonards Road, Windsor,
 Berkshire, SL4 3DD
 MICROS LIMITED Tel: Windsor (07535) 50111 Telex: 848521

Authorised  dealer Authorised **IBM** dealer
 Specialists in Computer Aided Design

KGB COMPUTER CLUB
 To: KGB Micros Ltd., 106 St. Leonards Road, Windsor, Berkshire SL4 3DD.
 Please send me full details of the benefits I can enjoy
 by joining the KGB Computer Club

Name _____
 Position _____
 Address _____

 Tel: _____

DESIRABLE though crossbreeds are in theory, the balance is not easy to strike. My impression after several weeks of using the PC-5000 is that Sharp has not got it right.

The machine is no bigger than a small portable typewriter, from which it seems to draw its design inspiration. First-time users may find the PC-5000 initially more friendly for this reason. Computer buffs, on the other hand, will be intrigued by its use of bubble memory to provide backing store.

Bubble technology is a non-volatile way of storing of data in a compact form with no physical moving parts. Rather as tape passes under a recording head, a chain of tiny magnetic domains is driven around a loop in a thin film of magnetic material by powerful electromagnetic coils. Under a microscope these domains appear as travelling moving bubbles, although no material is physically transported.

Like the CMOS RAM used in the lap portables as backing store, bubble memory is capable of retaining files while the machine is switched off. But CMOS RAM always needs a small current draining through it and is therefore not truly permanent. Bubble memory is as authentically non-volatile as floppy discs, and can be up to four times as fast.

The re-emergence of bubble memory in a consumer package as the PC-5000's drives A and B — actually a single physical drive with a split personality — may herald the start of a revival of interest. But bubble memory is still not cheap: its resemblance to discs ends when you check out the price list. A spare bubble will cost you nearly £170, or over 100 times as much per byte as

The Sharp PC-5000 and its optional built-in printer can be taken where the work is.

SHARP PC-5000

Chris Bidmead reports on a spell with this intriguing cross between a lap portable and a full-scale 16-bit desk-top machine.



conventional double-sided double-density floppies.

The basic variant of the PC-5000 comes with an empty space to the rear of the casing. But the printer unit intended for that slot belongs so much to the whole concept that it is almost a nonsense to consider the PC-5000 without it.

In the closed position the keyboard is concealed beneath a hinged lid that lifts to reveal an LCD screen on its underside.

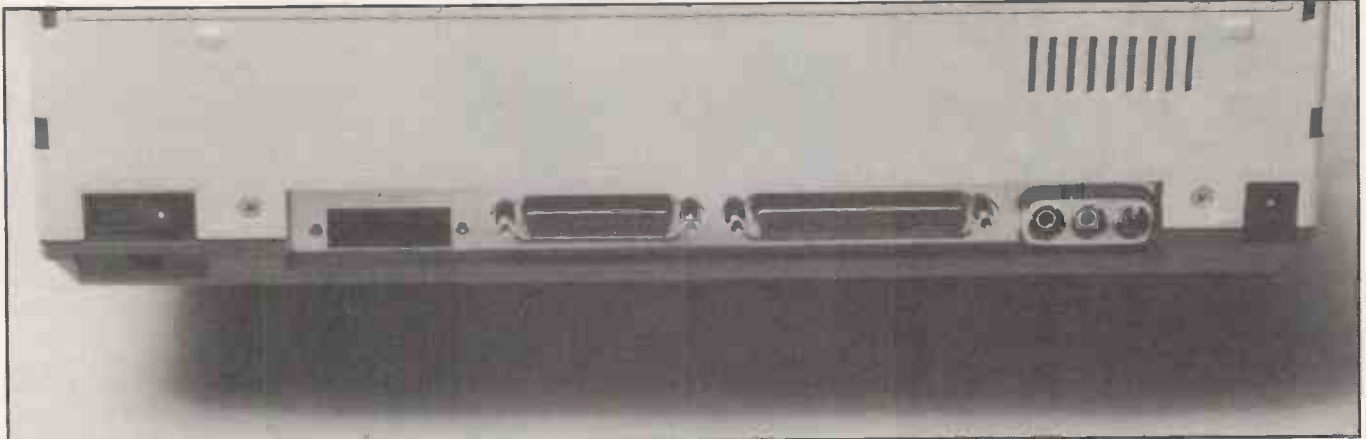

Above: Both cassette and RS-232 ports are provided at the back of the machine.

Below: The PC-5000 uses bubble memory for compact, lightweight mass storage.



Cassette data is monitored audibly.

Once opened, the eight-line 80-column screen sits astride the printer like a letter box on hinged stilts. It can be adjusted physically by tilting it relative to the keyboard, and electronically by a thumb wheel that alters the viewing angle of the screen's liquid crystals for maximum visual contrast.

The 57-key keyboard, supplemented by a top row of 15 function and cursor keys, is a joy to look at and to use. Command and function keys are dark grey, while light grey is used for the characters. A pair of orange keys in the top left of the keyboard turn the machine on and off and issue the Break signal.

Dull click

Slightly heavy typing pressure is needed, giving acoustic feedback as a dull click. My only two criticisms of the keyboard are that the Carriage Return is positioned two keys away from the home key of the little finger, and that the printed-circuit board supporting the keyboard flexes disconcertingly when you push down on it.

Compared to the legibility of the LCD screens in lap portables like the Tandy Model 100 and the NEC PC-8201, the Sharp PC-5000's display is a

Specification

CPU: Intel 8088 pseudo 16-bit plus CMOS eight-bit support chip

Memory: 128K RAM as standard, expandable to 256K, without the Basic ROM

Dimensions: 300mm. (12in.) x 310mm. (12.5in.) x 90mm. (3.5in.)

Display: LCD; 80 characters by eight lines, 640 by 80 pixels

Keyboard: standard QWERTY with 15 function keys

Interfaces: programmable RS-232, cassette port with motor switch, disc drive port

Discs: optional bubble disc pack, optional dual 5.25in. IBM-compatible floppy drives

Bundled software: only the ROM Basic is included in the first-level price

Additional software: MS-DOS 2, Superwriter, Supercalc 2, Supercomm, Superplanner are offered ready configured for the machine, either individually or as an integrated suite

Manufacturer: Sharp Corporation, Osaka, Japan
U.K. distributor: Sharp U.K. Ltd, Thorpe Road, Newton Heath, Manchester M10 9BE

disappointment. The characters are about half the size of those on the lap portables, but the MS-DOS Mode 40 instruction to double their size still does not go very far towards improving legibility.

There is a trade-off in all LCD screens between contrast and the unavoidable tendency of the glass-like covering of the screen to act as a mirror. The rather oblique angle of view on to a lap portable appears to be the best way of confronting a liquid-crystal display. On the PC-5000 it is not possible to tilt the screen more than a few degrees past the vertical, so in normal lighting you have to squint through the reflections in the covering to find the pale grey characters underneath.

Screen redirection

One antidote to the screen problem is suggested by a routine built into MS-DOS. CTTY enables you to redirect console output and input to the RS-232 port, to which you can attach a full-sized console. This provided some relief from eyestrain when I hooked up my favourite Cifer terminal. But while CTTY redirection works fine at the level of the operating system, the moment you enter Basic the

(continued on next page)

SHARP PC-5000

(continued from previous page)

console I/O reverts to the inscrutable letter box, and I could find no commands to override this.

Superwriter goes some way to coping with the inadequacies of the screen by putting up its text display in bold letters and reserving normal characters for the bottom line of the screen, which shows the menu options. Even so I found the letter box very hard to use for more than the odd jotted note.

Contrary to the fashion set for portables by Osborne, no software is bundled in with the PC-5000 hardware. Sharp does recommend Sorcim's Super family of integrated software — see article on page 126 of this issue — and can supply it on bubbles or on disc in special configurations for the machine.

Superwriter, for example, is sold as a disc alone, or in a package that includes a bubble and a disc. The bubble holds a cut-down version known as Executive Superwriter. The version on the disc is called De-Luxe Superwriter, and contains all the features of ordinary Superwriter on other MS-DOS machines. Only the De Luxe version was supplied for review, which was a pity as it meant anchoring the machine down to twin-floppy drives.

Superwriter configured for the Sharp letter box display is available on disc for £98, as is the Supercom communications package for £89, and Superplanner for £98. Of these only Superwriter was supplied for review, but the machine did arrive with Supercalc 2 on a bubble, in which form it costs £320.

Cramped window

Excellent though this Visiclone is on a full-sized screen, I found it a poor choice for the PC-5000, which really needs something specially written for it. Supercalc's message and co-ordinate areas take up half the screen, leaving only a cramped four-line window on the spreadsheet. I am told that other software available on bubbles includes dBase II, Scratchpad and Staredit, as well as the Desk Manager series from Kuma.

You can buy four quite adequate cassette recorders for the price of a single blank bubble cartridge, and have plenty of change left over for cassettes. So where speed is not essential, the cassette port that comes as part of the basic machine seems a tempting alternative. Even as a hardened disc user I have found that cassettes can make very reasonable backing store as long as the recorder has a tape counter, a motor switch controllable from the computer, and some means of listening to the data while



A rechargeable battery pack fits into a slot as the back of the casing.

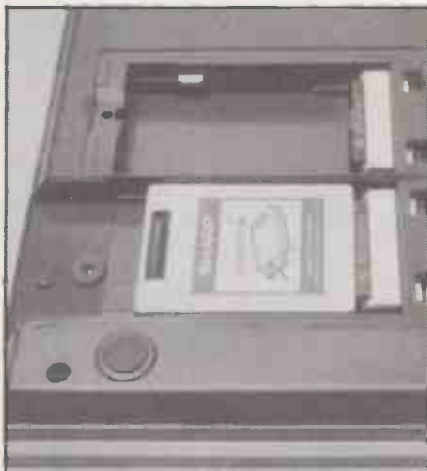

The ROM-based Basic operating system slots into the bottom of the machine.

transferring, winding and rewinding. For recorders that do not have all these features the cassette port of the PC-5000 tracks data transfer by echoing it over the internal speaker.

Two versions of Basic were supplied with the computer. Neither is equipped with a CSave statement but both allow saving to tape by redirecting the standard Save command to a device called Cas, which is a far better way of doing it. Curiously, cassette recorders have been completely overlooked at operating-system level. The MS-DOS command

`COPY DATA.TXT CAS:`

which you might expect to pipe the text file out through the cassette port, simply creates a new copy of the file called Cas. Writing device drivers under MS-DOS is supposed to be easy; somebody at Sharp should try it.

The built-in thermal printer is small, silent and slow. It takes over five minutes to print a single-spaced A4 page. The best character definition is obtained by using special thermal paper, though even then the quality does approach that of a daisywheel. An alternative is to use thermal transfer paper in conjunction with a thermal ribbon.

The transfer technique needs a specially smooth surface to give an image quality only slightly worse than direct thermal

paper. A dozen or so sheets are supplied with the machine, but Sharp U.K. does not appear to be interested in supplying any more. Instead you are advised to use a good-quality photocopy paper; a compromise that degrades the image even further. For direct thermal paper you are referred to W H Smith where it is available as stationery for Brother thermal typewriters.

The PC-5000 can be bought in a number of different configurations and upgraded simply, although the various steps on the way to the fully enhanced machine do not compare very favourably with the competition. For example, the cheapest PC-5000, with no printer or bubble, costs £1,195. The NEC PC-8201 and the Tandy Model 100 are not just better value, but better absolutely, at less than half the price.

Adding the printer for a further £275 begins to bring out the unique character of the machine, but doesn't make much sense unless you can run a word processor, which means adding bubble-based Superwriter for another £350 or so.

The printer brings the weight up to 6kg., or about four times as much as the NEC PC-8201, and obviously disqualifies it as a lap portable. You now have a desk-based single-drive 16-bit transportable — you could carry it comfortably to the car if it had a handle — with a slow printer built-in.

With one spare blank bubble for storing text — because you can't get to the cassette from Superwriter — it has cost you nearly £2,000, plus VAT. At that price it is hardly likely to send sales of Macintoshes and Apricots plummeting. To take full advantage of MS-DOS software from other sources, and to read IBM data discs, you will need to pay the extra £674 for the dual-disc drive.

Conclusions

- Some excellent design — though not enough — has gone into the PC-5000, and the keyboard is exemplary. The machine is also a beautiful piece of production engineering.
- The use of bubble memory is a bold design idea, but costly.
- Lack of support for the cassette port at MS-DOS level is a serious deficiency in a machine that is supposed to be portable.
- The letter box screen display is an ergonomic disaster. Bold characters, as used by Superwriter, help visibility a little, and you can achieve the same effect within Basic, but I scoured the manuals in vain for the command to do this from the operating system.
- The standard MS-DOS screen driver Ansi.Sys is not supplied with the operating system so there is no way for the mere user to configure software from suppliers other than Sharp.
- At a stage when most computers are trying to be the same, the Sharp PC-5000 is definitely different. Sometimes different is better, but not this time.



ORYX SYSTEMS (U.K.) LIMITED

MICROCOMPUTER HARDWARE, SOFTWARE AND ACCESSORIES WITH FULL AFTER SALES SUPPORT

SPECIAL INTRODUCTORY PRICES FREE DELIVERY IN THE UK FOR ORDERS OVER £200

CP/M SOFTWARE

ASHTON TATE	
D Base II*	£335
Financial Planner*	£375
Friday*	£170
BYROM	
BSTAM*	£115
BSTMS	£115
CAXTON	
Cardbox*	£145
DIGITAL RESEARCH	
Access Manager	£182
Access Manager - 86*	£242
Display Manager	£242
Display Manager - 86*	£304
C Basic	£90
C Basic - 86	£195
C Basic Compiler	£300
C Basic Compiler - 86*	£360
Pascal MT +	£210
Pascal MT + 86	£395
PL/1	£330
PL/1 - 86*	£450
FOX & GELLER	
d Graph*	£170
d Util*	£60
Quickcode*	£170
MICROPRO	
Calcstar*	£95
Infostar*	£255
Mailmerge*	£120
Wordstar*	£225
Word/Mail/Spell*	£450
Datastar*	£150
MICROSOFT	
Basic Compiler*	£250
Basic Interpreter*	£220
Fortran Compiler	£310
Cobol Compiler*	£475
Multipan*	£168
PEACHTREE	
Basic Accounting System	
per module	£300
Business Management Systems	
per module	£550
Peachcalc*	£80
Peachtext*	£155
Peachpack*	£300
SORCIM	
Supercalc*	£105
Supercalc 2*	£165
Superwriter*	£255
SAGE	
Accounting*	£350

Most popular machine formats are available.

SOFTWARE FOR IBM/PC

Please see CP/M listing. All products with an * will also run on MS-DOS and PC-DOS and are priced the same.

DIGITAL RESEARCH	
C Basic	£120
CP/M-86 + GSX	£40
Pascal MT +	£265
IUS	
Easy Filer	£235
Easy Speller II	£120
Easy Writer II	£185
EasyWrit/Spell/Mail	£385
MICROSOFT	
Fortran Compiler	£235
Flight Simulator	£39
Multi-tool Word	£248
LOTUS	
Lotus 123	£330
SOFTWARE SYSTEMS	
Multimate	£309
SORCIM	
Supercalc 3	£265

BOARDS FOR IBM/PC

AST RESEARCH	
Mega Plus 64K	£260
Six Pack Plus	£260
MICROSOFT	
64K RAM Card	£237
256K RAM Card	£600
Mouse	£130
System Card 64K	£290
QUADRAM	
Quadboard II 64K RAM	£280
Quadlink	£495

HOW TO ORDER

Simply write to Oryx (stating machine format and disk size), or telephone 01-636 0476 to place an order or make an appointment to discuss your requirements. Or ring 01-631 4341 without obligation to reach our technical advice hotline.

Orders will be acknowledged by return of post and goods will normally be despatched within 10 days. All products are supplied new and are sealed complete with manufacturers documentation and factory warranties.

All prices exclude VAT and are subject to change without notice.

Oryx Systems (U.K.) Limited, Mappin House, 4 Winsley Street, London W1N 7AR.

HERCULES	
Graphic Card	£330

MONITORS

(One year warranty)

KAGA	
Kaga RGB Vision-II 12"	£257
Kaga RGB Vision-III 12"	£369
SANYO	
Sanyo 12" Hi-Res Green	£98

PRINTERS

(One year warranty)

EPSON	
Epson RX-80 FT	£262
Epson FX-80	£349
JUKI	
Juki 6100	£399
MANNSMAN-TALLY	
MT 80	£225
MT 160	£449
STAR	
Delta-10	£359
Gemini 10X	£229
Gemini 15X	£329

All products subject to availability. CP/M is a registered trademark of Digital Research, IBM is the registered trademark of International Business Machines.

We cannot list all the products we carry - please call for further details.

ORYX - U.S. LEADERS IN TECHNOLOGY - NOW IN THE U.K.



● Circle No. 159

1984 On Course For Record Computer Sales

Sponsored by:

**Practical
Computing**
&
**YOUR
COMPUTER**

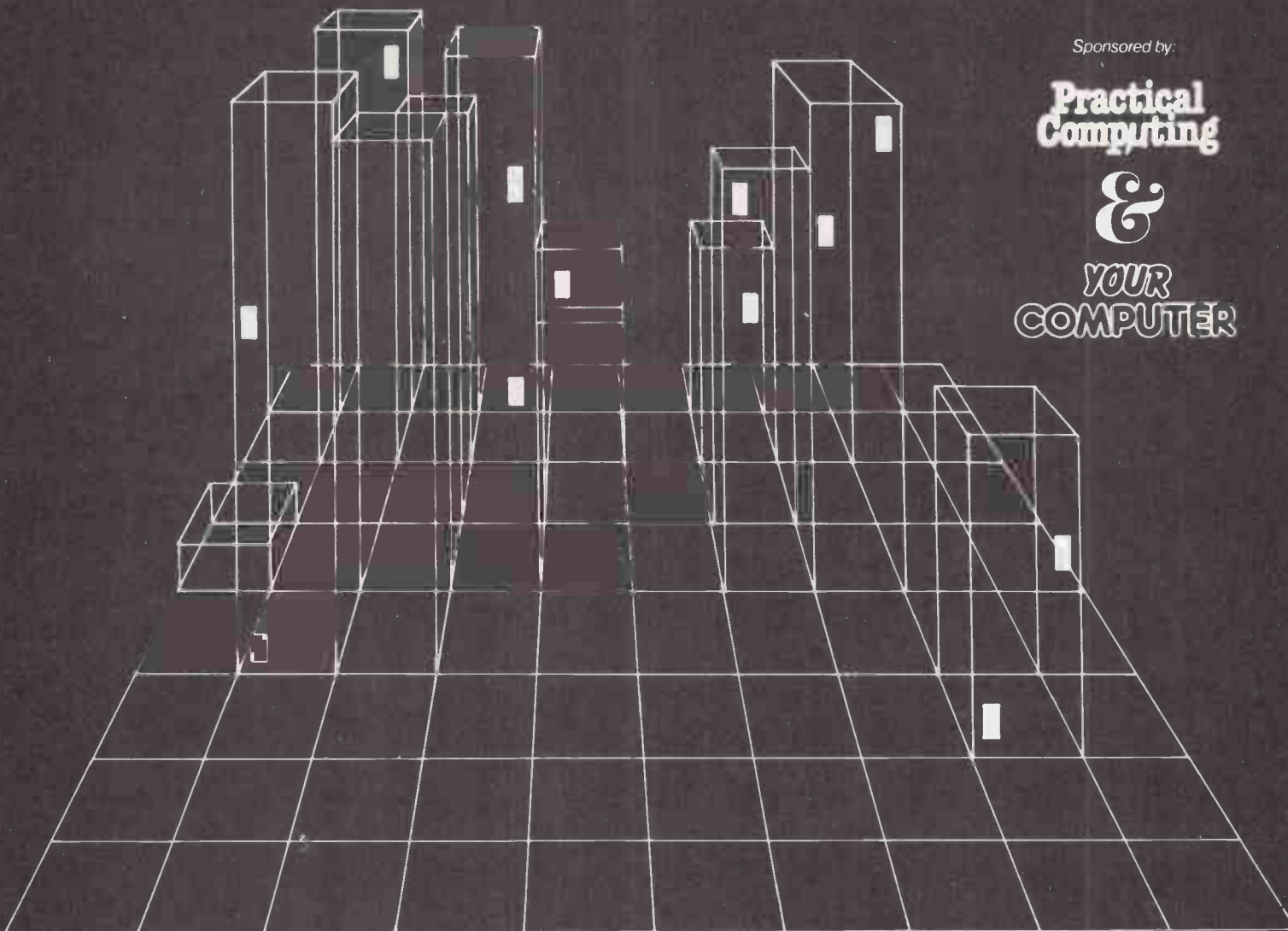

There can be few – if any – comparable exhibitions capable of generating such intense public interest as The Computer Fair series.

As expected, the 1983 Computer Fair, held at Earls Court, has consolidated its position as the major showcase for home and small business computers, to the extent that it became necessary for the original exhibition area to be doubled to a record 2,300 square metres. And all the signs are emerging to support our belief that 1984 will see further growth in an exhibition which provides an unrivalled opportunity for promoting personal computer systems of all kinds.

Sponsored by 'Practical Computing' and 'Your Computer' and organised by Reed Exhibitions, the 1984 London Computer Fair will again be backed by a massive publicity campaign using radio, television and press media. Advance stand reservations are understandably already well up on 1983. If you want to ensure that you do not miss out on a preferential site, you really must fill in the coupon below NOW, and return to the

Exhibitions Manager, The Computer Fair,
Reed Exhibitions, Surrey House, Throwley Way,
Sutton, Surrey. SM1 4QQ

THE
**Computer
Fair** *Personal computers
Home computing
Small business systems*
98 Earls Court, London. June 14-17 1984

I am interested in exhibiting at The Computer Fair, Earls Court,
London. June 14-17 1984.

Please send full information to

Name _____

Position in Company _____

Company _____

Address _____

Telephone No. _____

Telex _____

Four kinds of

LOGO is well worth learning, so I can recommend all the versions of the language reviewed here. Only in one case, the RML version of Logo, do I feel that the language is not as well served by its implementation as might be hoped. But Logo is so powerful that even in its worst version it is preferable to the Basics available on the computers in question.

Logo was invented by Seymour Papert and others with the aim of putting the user in charge of the computer. This is in contrast to notions of computer-assisted learning, or CAL, in which the computer is considered to be in charge of the user. At first the user was principally thought of as a child. Based mainly at MIT, Papert and his associates had a vision of a child programming the computer, rather than the computer programming a child as seemed to happen so frequently in CAL.

The child is of central importance in the development of Logo, because it was invented to enable creative learning in schools and, with the advent of microcomputers, in the home. However, the strong emphasis placed on the child has led some to erroneously believe that Logo is not a proper language in the way that, say, Pascal is.

Misunderstanding

This misunderstanding of the importance of Logo is compounded by the many versions of Logo which now abound, but are actually no more than versions of graphics systems. The name Logo is not copyright or a trademark, and so it can be used to describe any language or system without any legal restriction.

One of the most arresting facets of Logo for those new to the language is the way in which graphics are used, via the famous turtle graphics system. The development of turtle graphics arose out of working with Logo in schools. The original version of Logo had no turtle graphics, for at that time Logo was essentially a text-only language designed to assist with the manipulation of symbols.

Logo began as a list-processing language taking many ideas from Lisp, and turtle graphics were introduced later as a part of the Logo philosophy of continual development. Turtle graphics are an exceedingly powerful method of using graphics, and have appeared for many other languages. But to have a turtle graphics system is not necessarily to have a Logo system.

In the opinion of most Logophiles, a language cannot call itself Logo unless it has fairly complete list-processing facilities. A catalogue could be produced of software

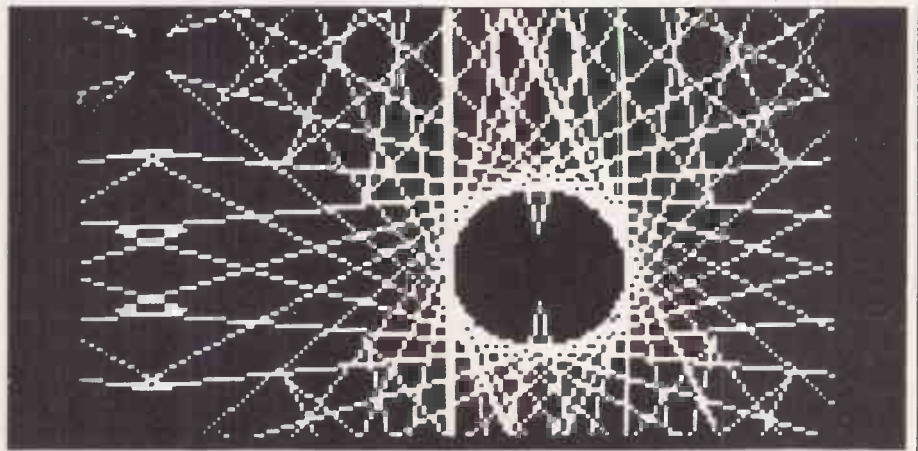

Turtle graphics help to make Logo accessible to all.

offerings which call themselves Logo, and which are no more than turtle graphics systems. But such systems are easily distinguished.

The earliest versions of Logo on microcomputers appeared for the Apple II and the TI 99/4. There was one TI version, which did not affect the development of other Logos to any great extent, and there were two Apple versions, which spawned versions for three out of the four computers being reviewed.

One version, known as Apple Logo, is a style of Logo now firmly associated with Logo Computer Systems Inc. which produces Atari Logo and Sinclair Logo for the Spectrum. The other version, known as Terrapin Logo, was produced by Terrapin Inc., an offshoot of MIT which produces the Commodore 64 version. The fourth version of Logo to be reviewed is the British Logo which comes from the Department of Artificial Intelligence at the University of Edinburgh. This version is only implemented on Research Machines 380Z and 480Z machines.

The Edinburgh style of Logo is by far the worst version, perhaps reflecting the Edinburgh philosophy, which is less child orientated than other Logo philosophies. Edinburgh Logo is designed to be used in conventional teaching regimes with conventional curricula, whereas the other Logos aim to break down conventional methods.

As turtle graphics arose from Seymour Papert's desire to help children follow their own course of learning, turtle graphics meshes well with MIT Logos. Turtle graphics does not fit in so well with Edinburgh Logo.

The Lisp parentage of Logo is clearest in the Edinburgh version, and its main drawback can be illustrated by a simple addition problem. If you want to add together three values and assign the value to

a variable named Newvar, in Terrapin Logo on the Commodore 64 you write

```
MAKE "NEWVAR 2+3+4
```

In LCSi Logo for the Atari and the

```
MAKE "NEWVAR 2+3+4
```

```
MAKE "NEWVAR (SUM 2 3 4)
```

whereas for Edinburgh Logo you write

```
MAKE 'NEWVAR ADD 4 ADD 2 3
```

The last version is not designed to be simple to understand. Edinburgh Logo may be logical in a Lisp-like way but it does not encourage ease of use.

Terrapin Logo uses the traditional and familiar form of addition by use of infix operators. LCSi Logo allows both the traditional infix form and a prefix form which is more flexible than the Edinburgh Logo prefix form. If one form has to be chosen, it would seem sensible to choose the infix version, though with the LCSi style of Logo you can have either.

Comparisons

Another very important difference between the Logos comes from the way in which the graphics screen is organised. In Terrapin Logo, if the turtle leaves the boundary of the screen in its travels then the track wraps round: this is the default arrangement. If the command Nowrap is issued there is no wrap-round and the turtle cannot leave the screen. If a journey would take the turtle out of bounds, then it cannot start.

Edinburgh Logo uses a different default, for the turtle cannot leave the screen unless freed by the command Noedges. The turtle's track does not, however, wrap-around: the screen is part of a much wider canvas for the turtle with co-ordinates ranging from -32757 to 32757.

In the LCSi versions the turtle starts in the same mode as the Terrapin versions, and if the command Fence is given the

Logo

Boris Allan assesses some developments of Seymour Papert's child-orientated language.

turtle cannot leave the screen. If a further command Window is given, then the turtle is freed. The screen is seen as a window on a much larger area. On balance, I prefer no wrap-around to wrap-around if I have to have one or the other, but overall I prefer to be able to choose.

On average I think the LCSi version wins, though there is a mysterious disappearance of a command from the LCSi versions, compared to Apple Logo. The disappearance is, unfortunately, rather important. Suppose you wish to write a procedure which for some reason needs variables that are local to the procedure. In Terrapin Logo you write

```
LOCAL "NEWVAR
```

and in Edinburgh Logo you write

```
NEW 'NEWVAR
```

but in the two LCSi versions you use a dummy parameter for a procedure.

Backup

The quality of the backup which comes with each version varies. The worst comes with RML Logo, even though there are two manuals — a reference guide and the beginners' guide. The text of both is remarkably uninformative and rather disorganised.

The manual to accompany Commodore 64 Logo is very complete, but very difficult to read or use if you are not already a Logo expert. The organisation of the page numbering itself is unhelpful. The first section is concerned with graphics, and is numbered G-1; the next section is concerned with computation, and starts with C-1; the next section comes words and lists, and starts W&L-1, and thus it continues.

If you are using the index and look at "Assembler/Logo interfacing", the page is given as A-126. But A-126 is not the Assembler section, it is the appendix. To find A-126 means going through the manual until you encounter pages with the prefix A. Each section in the manual is supposed to be independent of any other so each section tends to repeat certain strictures on pressing Return for example. It is not an easy manual from which to learn and the diagrams are not sufficiently clear, but it is a very complete reference manual.

The best manuals are those which come with Atari Logo. There are three documents: an introduction for beginners, a reference manual, and a quick reference guide. These are excellent, and easily followed by the novice. The Spectrum Logo version I examined was a pre-production version, and there were no manuals, but I understand that since Spectrum Logo is from LCSi the manuals

will follow the same format as the excellent Atari manuals.

The implementations of the arithmetical procedures on both the Atari and the Spectrum seem to use routines from within Basic. For the Atari version this does not matter, because there are no real flaws in the Basic arithmetical routines. On the Spectrum, however, this means that one of the irredeemable defects of the Spectrum Basic arithmetic is repeated. A simple way of showing the Spectrum error is to use the recursive procedure defined by

```
TO HALF :NUMBER
```

```
PRINT :NUMBER
```

```
HALF :NUMBER/2
```

```
END
```

and then enter

```
HALF - 1
```

to which a series of numbers is output; each half as large as the previous value. The series continues until the number $-2.9387359E-39$ repeats and repeats. This error is also present in Spectrum Basic. As Spectrum Logo obviously uses routines from Basic, this means that it is more difficult to produce Logo on a switchable ROM.

Both Atari Logo and Spectrum Logo use the standard Basic form for expressing numbers with negative exponents, such as $1E-39$. Whereas Commodore 64 Logo uses the more traditional Logo form, that is, $1E-39$ is written $1N39$. There are errors in the Basic 2 routines used for arithmetic on the Commodore 64, but there are no such errors in Logo, which suggests that the routines are completely new. If you want to use the Commodore 64 for arithmetic, then Logo seems to be more accurate.

Where turtle graphics are concerned the Atari is excellent because of the way in which multiple turtles may be used simultaneously, at different speeds, with potentially complex collisions and crossings being monitored by the When demon. It is an amazingly sophisticated system, but one for which the resolution is lower than any of the others, strange as it may seem. Turtle graphics on the Atari are the chunkiest of any of the four versions. There are rather severe restrictions on the sizes of numbers you can use as inputs to turns and forwards, which can be annoying in some recursive procedures. The Atari version of Logo must be accounted as excellent on any criteria.

With the Logo disc on the Commodore 64 there is also a utilities disc with arresting demonstrations of the use of sprites. Thus in Commodore 64 Logo there comes a set of sprite routines which should have been present in the original Basic. The Logo system allows the user to do all the things you wanted to do in Basic, but were so tedious: a result of the Logo philosophy of

making computers easy to use. One of the other useful features of Commodore 64 Logo is that it has a built-in assembler.

The Spectrum turtle graphics are good, but in no way as extensive as the previous versions, perhaps because the Spectrum itself is less powerful. The graphics are nice and easy to use, but lack the flexibility of the Atari and the Commodore 64. The Spectrum graphics also lack the multiple turtle and sprite capabilities of the first two versions. It is still a nice version though.

The turtle graphics on the RML are on a par with those of the Spectrum, but given the difference in price of the hardware it should have been closer to the facilities of the Atari and Commodore 64. One facility that the RML has over the Spectrum is that the turtle can run at two speeds. It does not have as many colours of lines or colours of backgrounds as the Spectrum.

All the versions have good list-processing facilities, and on the Commodore 64 there is even an adventure game written in Logo. However, there is little to choose between the versions. The RML version soon runs out of memory, the Atari and Spectrum versions are intermediate, and the Commodore 64 scores heavily in this context.

Conclusions

- The two best versions are Commodore 64 Logo and Atari Logo.

- If you have an Atari it is worth getting the Atari version, which is on cartridge for £59. Schools can purchase an Atari 600XL with Logo for £175, which is a bargain.

- Commodore 64 Logo comes as a package with two discs and an indigestible manual for £34.95. Given the power of the system any Commodore 64 owner with a disc drive is well served by this version.

Not only are sprites and high-resolution graphics easily accessible, but the arithmetic, list-processing, and machine-code capabilities are worth the price. Schools can get a special offer of a Commodore 64, Vic 1541 disc drive, Logo, and Simon's Basic for £295. As it is disc-based, perhaps it is not for primary schools.

- Spectrum Logo is a good version with full list processing and will cost about £40. Schools who already have a Spectrum are being given preference. When Spectrum Logo becomes generally available — perhaps at a lower price — it will be a good buy.

- RML is the version for which I have least enthusiasm. This Logo will do everything you want it to, especially on the list-processing side. A school with an RML machine should buy Logo.

THE BBC'S telesoftware service uses its standard teletext transmissions to convey software. Unlike the Basicode system described in last month's *Practical Computing*, teletext can broadcast software simultaneously with normal programmes. It is therefore possible to transmit software throughout the day, and even to update it, if necessary.

Broadcast UHF television signals in Britain make provision for 625 lines of picture information, though fewer than 600 of them are actually displayed on the screen. Some carry signals which keep the receiver synchronised with the transmitter and a few are used by the broadcasting authorities to transmit technical information for internal use.

Four of the remaining spacelines are now used to transmit teletext information in the form of ASCII codes. The teletext decoder built into some domestic TV sets converts these signals into static screens of information.

Information trees

Both BBC1 and BBC2 have a basic set of 100 pages, each of which can have up to 99 sub-pages. Pages and sub-pages may be linked together, allowing various kinds of structured trees of information to be set up. There are currently over 6,000 frames on Ceefax; a sweep through those on offer typically takes about 12 seconds.

The latest development extends BBC1's Ceefax teletext transmissions to include about 10 further pages and their associated sub-pages. They not only contain text files, as in conventional Ceefax, but also machine-readable files that can be downloaded and run.

At the moment only the BBC Micro can be adapted to act as a combined teletext and telesoftware terminal. With suitable hardware other machines could also be used, and the BBC is not against this in principle. The teletext adapter is supplied by Acorn and costs £196 plus VAT.

The adaptor is housed in an add-on box which is the same depth as the BBC Micro and half the width. It has its own power supply, and connects to the micro via the 1MHz bus. Unfortunately the plug fits into the socket in two ways; only experimentation reveals which is correct. A ROM chip supplied with the teletext unit must be plugged into one of the spare slots inside the micro, next to the MOS and the Basic ROM.

For teletext reception — and in particular for error-free telesoftware — you need a good, strong UHF signal. It is fed into the back of the teletext adaptor, and video output is then taken from the BBC Micro in the normal way. Four tuning knobs next to the aerial input are available to tune into the four TV channels offering teletext. A horizontal bar on a special tuning screen indicates signal strength, and the screen also indicates which channel is being received. Tuning is a rather tedious process, partly because a large number of turns of

Programs on TV

Glyn Moody continues his series on broadcast software with an assessment of the BBC's Ceefax-based service and the Acorn/BBC Teletext System.

the tuning wheel are needed to cover the broadcast spectrum.

The BBC Micro's function keys control the operation of the system. You select a channel by pressing F4 followed by the channel number. Pressing -F4 Shift calls up the fine-tuning screen. A specific page is called by F0.

You are likely to be greeted by the message

waiting for page

since Ceefax is unlikely to be broadcasting the page you want at the very moment you

call it up. The current page number is displayed at the top of the screen, continuously changing at about 10 pages per second. As soon as the required page is reached it is displayed on the screen. Sub-pages are stored at the same time — as long as there is room for them — and may be called up instantaneously by typing a link number.

Other function keys allow the last explicit page — that is one that was called for by number, rather than via links — to be selected. This can be used to return you to

Copyright

Telesoftware is broadcast free. Apart from the adaptor, all you need to receive the programs is a standard TV licence. This applies even if the adaptor is being used with a monitor rather than a domestic TV set. Domestic users of a program broadcast on Ceefax may make two copies for private purposes and adapt or modify it for similarly private purposes, but not for sale. Educational establishments may record, use, adapt and even distribute a program, but only for their own educational and training purposes, and not for sale.

Specification

Waveband: Access to teletext and telesoftware services broadcast on UHF channels E21 to E69
Data rate: Maximum data capture approximately 128Kbaud
Size: 70mm. high by 210mm. wide by 350mm. deep
Manufacturer: Acorn Computers Ltd
UK distributor: Vector Marketing, Denington Estate, Wellnborough, Northamptonshire NN8 2RL.
Telephone: (0933) 228953
Price: £196 plus VAT



The BBC Micro and teletext adaptor, with the main Ceefax page on the screen.

the top of a tree structure, which is usually the index page. It is also possible to store single pages to cassette or disc, or load them from file.

The telesoftware pages, stored on Ceefax pages 700 to 710, are accessed in exactly the same way. There is, however, a slight difference in the way in which the pages are linked together to form the complete programs. A Ceefax page typically holds about 750 bytes so most programs will run to several pages. The pages are sent out in turn with each sweep through Ceefax.

If the file contains a Basic program whose lines are numbered the pages can be stored as they come — you do not have to wait for page 1 to come up before loading the rest. They are then rearranged using the line numbers when all pages have been received. Such files are called disordered, since they can be sent in this unstructured way. Ordered files, on the other hand, must be sent sequentially, starting with page 1, since lines are not numbered in the program. Once downloaded, programs are run in the normal way using the Run command.

With the system in Teletext mode the only programs you can run are those which have been downloaded from Ceefax. In the alternative Telesoft mode you can run this

telesoftware and your own programs as well. The function-key calls for downloading software are not available in Telesoft mode, and you have to key the appropriate commands explicitly.

The main problem of using the teletext software system is the delay in receiving pages. There is scope for some improvement when two extra lines are allocated to Ceefax, although they may be used to allow more pages to be transmitted in the same time.

One advantage of Ceefax telesoftware over Basicode is that each page is error checked. A page can only be downloaded if it is error free, so any program that gets as far as your micro's memory should run satisfactorily.

Four of the Ceefax telesoftware pages can be read from the screen while the rest are only machine readable. Page 700 gives an overall index, 701 a directory of programs currently on offer and 702 a series of sub-frames that give short descriptions of the software. Page 703 carries background information and software reviews. Each subsequent page and its associated sub-pages then contain programs of varying length. They are sent in an extended eight-bit ASCII code.

At the moment software is being changed

every two weeks, though there is a possibility that it may soon go weekly. It is broadcast for the full duration of the other television services.

The programs are from a number of sources. Some of BBC Radio 4's *Chip Shop* Basicode software is offered, as well as programs sent in by members of the public. A major proportion is provided by Telesoft, a group based at Brighton Polytechnic. Like much of telesoftware, this is educational, and sometimes ties in directly with schools radio broadcasts.

The telesoftware service is geared very much to providing such learning aids and home programming utilities. Future sources may include professional software houses.

Daily updates

Other possibilities under consideration include linking software to other volatile information stored elsewhere on Ceefax pages. For example, a program dealing with stocks and shares or commodities could link to prices and financial indexes. Already a simple program designed to teach the basics of nutrition and dietetics allows a menu of foods to be linked to current shop prices, which are updated daily by Ceefax. A program dealing with taxation could be provided, for example, and revised each year after the Budget simply by downloading the latest version.

Telesoftware is intended to form part of a new kind of integrated package — not so much with other software as with other media like radio and television. In addition to the schools broadcasts, there are plans to make programs from the new BBC TV series *Computers in Control* available on the system.

Although telesoftware was first launched last September, it is only now that the BBC and Acorn are gearing up their advertising campaigns. There are currently about 6,000 users, and this is increasing at the rate of about 300 a month. Having led the world, BBC's telesoftware system looks set to become the standard. Australia, Italy and Sweden are all considering starting similar services.

The initial research began about four years ago as a joint project between the BBC, IBA, Brighton Polytechnic and Mullard, which hand-built the first telesoftware receivers. Full-scale implementation had to wait for the introduction of a suitable host computer. With its many buses, the BBC machine is well suited to such applications, though its limited memory size is becoming a little restrictive as other machines climb into the hundreds of K.

The related medium of cable promises some excitement. Software can be supplied using technology which exactly parallels that of broadcast telesoftware. Once multi-channel media become widely available, the patterns of TV use — not to mention software publishing — will never be quite the same again.



Four tuning knobs lie next to the aerial input.

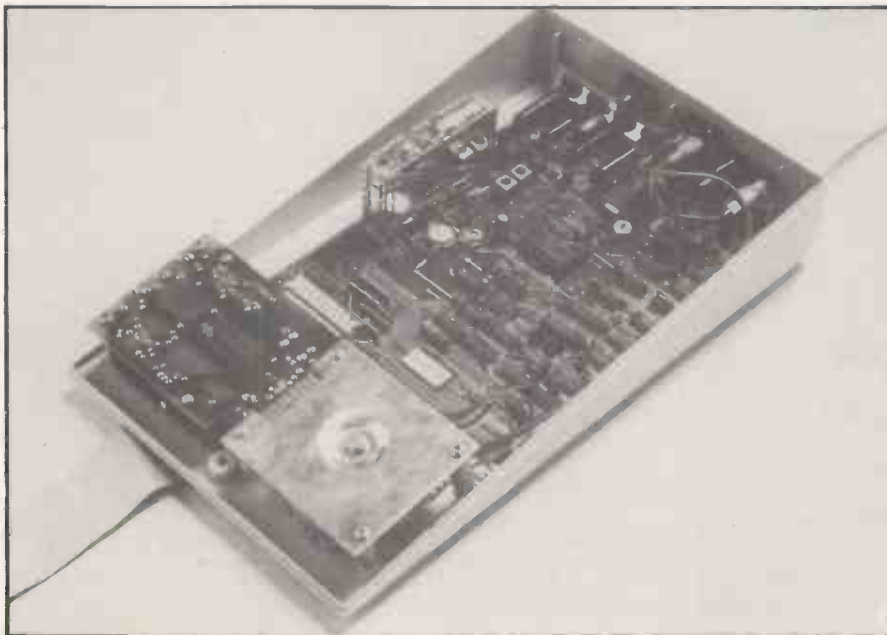

Inside the teletext adaptor add-on box.

SUPPOSE YOU have a small machine shop with three machines. You make two products: widgets and gizmos. Widgets give you a profit of £50 per unit, while from gizmos you only clear £30. At first sight there is no problem: make as many widgets as you can sell, and leave the gizmos to take up the slack.

But life may not be that simple. Both the gizmos and the widgets are cast on the casting machine, ground on the grinding machine and polished on the polishing machine. The trouble is that the profitable widgets take longer on the grinder than on any of the other machines. If you only make widgets, the casting machine and the polishing machine lie idle for part of the time.

Maximum profit

The gizmos, on the other hand, do not need as long on the grinder as they do on the polisher, so you could even things out a little by making a few of them. But then you have to find time on the grinder, so you cannot make as many of those lucrative widgets. How many of each should you make to maximise your profits?

It is this kind of problem that can be solved by the technique known as linear programming. You start with a set of mathematical inequalities to represent the constraints on the system — in this case the

Filling in the gaps

Adrian Hill presents a program for the Simplex algorithm, which can be used to plan the most effective use of scarce resources.

time available on each of the machines.

Suppose the casting machine and the grinding machine are available for 10 hours each day, and the polishing machine is available for 12 hours a day. Using the data in table 1 you can write the following inequalities:

$$\begin{aligned} 4x + 5y &\leq 10 \\ 5x + 2y &\leq 10 \\ 3x + 8y &\leq 12 \end{aligned}$$

where x is the number of widgets you make each day, and y is the number of gizmos.

The profit you make on each day's work

is represented by the equation

$$P = 30y + 50x$$

To maximise your profit you have to maximise the equation. It can be rearranged to

$$P - 50x - 30y = 0$$

	Caster	Grinder	Polisher
Widget	4	5	3
Gizmo	5	2	8

Table 1. Hours on each machine to make one widget or one gizmo.

```

5 REM *****
10 REM
15 REM LINEAR PROGRAMMING PACKAGE
20 REM
25 REM A P HILL, OCT. '83
30 REM
35 REM *****
40 REM
45 REM
50 REM variables etc. used...
55 REM
60 REM AN$ - users response
65 REM NUM - no. of equations used
70 REM VAR - no. of variables in each
75 REM NAM$(X,Y) - variable names
80 REM MAT(X,Y,Z) - original and new matrix
85 REM EN, SL - flags for end of processing
90 REM PX, PY - X and Y co-ord. of pivot
95 REM TEMP - used to find most -ve value
100 REM TST - used to find smallest ratio
105 REM PV - value of pivot
110 REM TNAM$ - temp store for swapping var. names
115 REM CP,BP,CP - used to work out value in point 7)
165 REM
170 REM
175 REM
180 REM *****
185 REM
190 CLS
200 PRINT " LINEAR PROGRAMMING "
210 PRINT " ----- "
220 PRINT:PRINT
230 PRINT " Your equations should be ready."
240 PRINT " Enter them as prompted."
250 PRINT:PRINT
260 PRINT "press any key to continue.":GET AN$
270 CLS
275 PRINT:PRINT
280 INPUT " How many equations have you?":NUM
290 PRINT
300 INPUT " How many variables in each?":VAR
310 CLS
315 PRINT:PRINT
320 PRINT " You have ";NUM;" equations of ";VAR;"
variables."
330 PRINT:PRINT
340 INPUT " Is this correct? (y/n)":AN$
350 IF (AN$="Y") OR (AN$="y") THEN 370 ELSE 270
360 GOTO 310
370 CLS
375 PRINT:PRINT:PRINT
380 PRINT " Enter names for your ";VAR;" variables."
390 PRINT:PRINT:PRINT
400 FOR TC= 1 TO VAR
410 PRINT " variable no. ";TC;" name is ";
420 INPUT NAM$(TC,0)
430 NEXT TC
440 CLS
445 PRINT:PRINT:PRINT
450 PRINT " Your variable names are:"
460 PRINT:PRINT:PRINT
470 FOR TC = 1 TO VAR
480 PRINT NAM$(TC,0)
490 NEXT TC
500 PRINT:PRINT
510 INPUT " is this correct? (y/n)":AN$
520 IF (AN$="Y") OR (AN$="y") THEN 540 ELSE 370
530 GOTO 440
540 CLS:PRINT:PRINT:PRINT:PRINT " Enter the values
for each equation."
550 FOR CN = 1 TO NUM
560 PRINT " equation number ";CN
570 FOR CV = 1 TO VAR
580 PRINT " value of ";NAM$(CV,0);" is ";
590 INPUT MAT(CN,CV,0)
600 NEXT CV
610 INPUT " value of limit is ";MAT(CN,0,0)
615 CLS:PRINT:PRINT:PRINT
620 FOR CV = 1 TO VAR
630 PRINT " value of ";NAM$(CV,0);" is ";MAT(CN,CV,0)
640 NEXT CV
650 PRINT " value of limit is ";MAT(CN,0,0)
660 PRINT:PRINT:PRINT
670 INPUT " are these correct? (y/n)":AN$
680 IF (AN$="Y") OR (AN$="y") THEN 700 ELSE 560
690 GOTO 620
700 NEXT CN
710 CLS
720 PRINT " now enter profit function"
730 PRINT " don't forget 0 -A -B notation."
740 FOR CV = 1 TO VAR

```

Linear programming

The problem can be solved manually by what is known as the Simplex method. You first arrange the equations into tabular form, setting up a matrix as shown in matrix 1. Compare this matrix with the set of equations to see how it is set up. A, B, and C are dummy variable names which are added for convenience.

To solve this matrix you repeatedly perform the following procedure until there are no negative values on the bottom or target row of the matrix. The procedure is applied using the values in the first matrix to form a new matrix. This second one is used to form a third, and so on.

1. Select the most negative entry in the bottom or target line. In the first matrix this is in the X column.
2. Consider the ratios 10/4, 10/5, and 12/3. Select the smallest ratio. In the first matrix this is in the B row.
3. The point of intersection of the row and column selected in 1 and 2 is called the pivot. In the new matrix exchange the

names of the row and column containing the pivot.

4. To form the next matrix:
 - i) Replace the pivot by its reciprocal.
 - ii) Considering the other matrix positions, if the value b is in the row containing the pivot, but is not the pivot itself, replace b by b/pivot in the new matrix.
 - iii) If the value c is in the column containing the pivot, but is not the pivot itself, replace c by -c/pivot in the new matrix.
 - iv) If the value z is not dealt with in ii or iii then replace z by

$$z - bc/\text{pivot}$$

in the new matrix.

Using these rules you get to the new matrix 2. There is still one negative value on the bottom line, so it is not the required solution. Repeating the process, starting with matrix 2, gives matrix 3. There are no negative values on the bottom row, so this is the solution.

From matrix 3 you can read off the final values. Maximum profit of 1,800/17 is

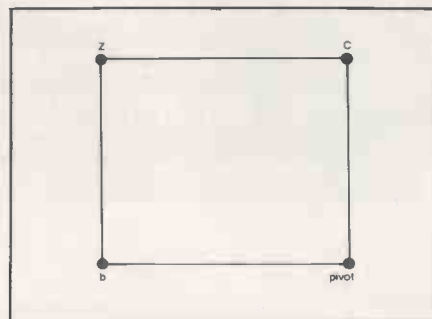

Row, column and pivot positions for transforming the matrix.

obtained when 30/17 units of X and 10/17 units of Y are produced per day.

The listing gives a Basic program which will solve sets of inequalities by repeatedly applying the Simplex method. It also interprets the results by identifying the relevant entries in the matrix. The program was written in Microsoft Basic on an Oric 1 and so should require little alteration for most machines.

		X	Y
A	10	4	5
B	10	5	2
C	12	3	8
P	0	-50	-30

Matrix 1.

		B	Y
A	2	-4/5	17/5
X	2	1/5	2/5
C	6	-3/5	34/5
P	100	10	-1

Matrix 2.

		B	A
Y	10/17	-4/17	5/17
X	30/17	5/17	-2/17
C	2	1	-2
P	1,800/17	166/17	5/17

Matrix 3.

```

750 PRINT " value of ";NAM$(CV,0);
760 INPUT MAT(0,CV,0)
770 NEXT CV
780 CLS
790 FOR CV = 1 TO VAR
800 PRINT " value of ";NAM$(CV,0); " is ";MAT(0,CV,0)
810 NEXT CV
820 PRINT:PRINT:PRINT
830 INPUT " are these correct? (Y/N)";AN$
840 IF (AN$="Y") OR (AN$="y") THEN 860 ELSE 710
850 GOTO 780
860 CLS
870 PRINT " Processing data now..."
880 NL=0
890 GOSUB 1100
900 GOSUB 1200
910 GOSUB 1300
920 GOSUB 1400
930 GOSUB 1700
932 CLS:PRINT " LOOP NO. ";NL+1
934 FORX=0TONUM:FORY=0TOVAR:PRINTMAT(X,Y,0):NEXTY:
PRINT:NEXTX
940 NL=NL+1
950 IF (NL=10) THEN 970
960 IF (EN=0) THEN 890 ELSE 1000
970 PRINT:PRINT:PRINT
980 PRINT " No solution after ten loops ! "
990 GOTO 1010
1000 GOSUB 1900
1010 STOP
1100 REM pick most -ve on profit line
1110 PX=0 : TEMP=0
1120 FOR PF = 1 TO VAR
1130 IF (MAT(0,PF,0)>=0) THEN 1170
1140 IF (MAT(0,PF,0)>=TEMP) THEN 1170
1150 TEMP = MAT(0,PF,0)
1160 PX=PF
1170 NEXT PF
1180 RETURN
1210 TST=100
1220 FOR PF = 1 TO NUM
1230 TEMP = (MAT(PF,0,0)/MAT(PF,PX,0))
1240 IF (TEMP<TST) THEN TST=TEMP : PY=PF
1250 NEXT PF
1260 RETURN
1300 REM swap names and modify pivot

```

```

1310 PV = MAT(PY,PX,0)
1320 TNAM$ = NAM$(PX,0)
1330 NAM$(PX,0)=NAM$(PY,1)
1340 NAM$(PY,1)=TNAM$
1350 MAT(PY,PX,1)=1/MAT(PY,PX,0)
1360 RETURN
1400 REM other processing
1410 FOR CL= 0 TO VAR
1420 FOR RW= 0 TO NUM
1430 IF (CL=PX) THEN 1500
1440 IF (RW=PY) THEN 1500
1450 CP= MAT(RW,PX,0)
1460 BP= MAT(PY,CL,0)
1470 SB= CP*BP/PV
1480 MAT(RW,CL,1)= MAT(RW,CL,0)-SB
1490 GOTO 1620
1500 MAT(RW,CL,1)= MAT(RW,CL,0)/PV
1510 GOTO 1620
1600 IF (RW=PY) THEN 1620
1610 MAT(RW,CL,1)= 0 - MAT(RW,CL,0)/PV
1620 NEXT RW
1630 NEXT CL
1640 RETURN
1700 REM test for a solution
1710 SL=0 : EN=0
1720 FOR PF= 1 TO VAR
1730 IF (MAT(0,PF,1)<0) THEN SL=SL+1
1740 NEXT PF
1750 IF (SL=0) THEN EN=1 : GOTO 1810
1760 FOR CL= 0 TO VAR
1770 FOR RW= 0 TO NUM
1780 MAT(CL,RW,0)= MAT(CL,RW,1)
1790 NEXT RW
1800 NEXT CL
1810 RETURN
1900 REM now print solution
1905 PRINT:PRINT:PRINT " *** solution found ***":
PRINT:PRINT
1910 FOR NM= 1 TO NUM
1920 IF (NAM$(NM,1)="") THEN 1950
1930 PRINT NAM$(NM,1); " = ";MAT(NM,0,1)
1950 NEXT NM
1955 PRINT:PRINT " max. value is : ";MAT(0,0,1)
1960 RETURN

```

If you want it tomorrow . . .
call us today
01-455 9823

COMPUTER/CALCULATORS/PLOTTERS

HEWLETT PACKARD		HP 16C (Hex Con)	£84.00
HP 4 1C (Card Reader)	£129.95	HP 15C (Adv Sci)	£84.00
HP 4 1CV (SCI Comp Cal)	£176.00	HP 75C (Portable)	£650.00
HP 4 1CX (Computer)	£220.00	HP 75C portable cassette drive	£290.00
Printer 82143A	£230.00	HP Plotter 7470A RS232 or HP1B	£799.00
Printer 82162A	£300.00		
SHARP		New HP 150 personal office computer terminal unit or upgradable with disc drives to 14.7M bytes	£2300.00
PC 1500 Pocket Computer	£130.00	Epson QX-10 (desk top comp)	£1700.00
CE 148 RS232 and Cent I/F	£130.00	EPSON HX20 Briefcase computer. 16K expandable. 64k Rom, 32K Ram. Full size ascii keyboard. Runs on own power for 50 hours. Serial and RS232 interface.	£375. Accessories & Software for Epson HX20 available from stock.
CE 158 printer/cassette I/F	£130.00		
CE 159 BK Add on mem with BATE	£79.00		
CE 152 Cassette	£36.00		
MZ-711 Computer	£199.00		
MZ-711 Printer Plotter	£110.00		
MZ-8080AEU Exp Unit	£86.00		
PC 1251 (Computer)	£69.00		

WORD PROCESSING PRINTERS/MONITORS

NEC 2000 (RS232 or Centronics)	£650.00	BROTHER* "Highly Recommended"	
7710 RS232/7730 Centronics	£1650.00	HR1	£598.00
Tractors, Sheet Feeders and Paper Guides for NEC, Ex-Stock		Serial or Centronics --	
UCH IDA 305 (18CPS)		HR15 (3K Buffer 18 CPS)	£399.00
Low cost daisywheel	£375.00	HR25 (3K Buffer 25 CPS)	£715.00
QUME		DIABLO 630*	
9/45 RO-FFP	£1650.00	620(RO)	£650.00
9/55 RO-FFP	£1999.00	630(ECS)	£1850.00
11/40 RO (Also IBM-PC)	£1225.00	630(API) (IBM COM)	£1400.00
		630(KSR)	£136.00
		Tractor (Epson)	
		FUJITSU	
		HEEL	
		Sheet Feeder	
		(Bi-Di)	
		Mechanical Sheet Feeder	
		OLYMPIA*	
		ESW 103	£899.00
		TOSHIBA	
		The all in one word processor	
		Processing/Draft/Data Processing printer using a - 24 wire printhead to give exceptionally high letter quality output	
		COLOUR MONITOR from	£220
		TEC STARWRITER*	
		F10-55 CPS (serial/parallel)	£139.00
		Tractor (Bi-Di)	
		Sheet Feeder	
		Mechanical Sheet Feeder	
		OLYMPIA*	
		ESW 103	£899.00
		TOSHIBA	
		The all in one word processor	
		Processing/Draft/Data Processing printer using a - 24 wire printhead to give exceptionally high letter quality output	
		COLOUR MONITOR from	£220
		RUTISHAUSER	
		Sheet Feeders and Tractors for: Qume, Diablo, NEC, Ricoh, TEC Starwriter, Olivetti, etc.	From £99.00
		RICOH*	
		Model RP 1300 (S) (4K Buffer)	£990.00
		Flowriter (8K) PR 1600	£1450.00
		IBM-PC Version	£1500.00
		Mechanical Sheet Feeder	£475.00
		Tractor Feed	£175.00

DOT MATRIX PRINTERS

OKI*		SEIKOSHA GP700A Colour	£378.00
M82A (120 CPS)	£295.00	GP-100A	£210
M92P (160 CPS)	£425.00	(RS232 Option)	£63
Tractor	£50.00	GP-100 (VIC 20)	£175.00
M83A	£499.00	GP-250X	£220.00
(120cps Friction, removable Tractor and RS232 and Centre/Par standard)			
M84A	£695		
ANADEx*		EPSON	
DP-9000 B/(180 CPS)	£850.00	Epson RX80 (100cps)	£245.00
DP-9500 B/(180 CPS)	£893.00	Epson FX80 (160cps)	£350.00
DP-9625 B/(240 CPS)	£1155.00	Epson RXBOFT	£260.00
		Epson MX100 Type III	£399.00
		Keyboard	£210.00
		Epson FX100FT (160cps)	£487.00
		Epson I/F and accessories from	£29.50
		BROTHER	
		EP22 Portable (Ideal for Atari/Commodore 64/Vic Nec PC8201/sharp. PC1500 Etc. Printer/Typewriter/Calculator	£165.00

STOP PRESS NOW IN STOCK IBM/PC
IBM/PC SUPPLIED ON VERY COMPETITIVE TERMS. ALSO AVAILABLE EXTENSIVE RANGE OF SUPPORT HARDWARE/SOFTWARE

DIGITEK ACCESSORIES FOR APPLE COMPUTERS		Z80 Expander card	£89.00
64K RAM CARD	£149.00	RS232 High Speed Ser I/F card	£85.00
128K RAM CARD	£299.00	Screen master 80	£129.00
PAL Colour Encoder	£79.00	I/F Cards for Epson/Nec/Tec Microline	£98.00

SOFTWARE

Word Processing APPLE		Word Processing IBM	
Applewriter 1.1	£85.00	Wordstar	£285.00
Applewriter 2	£85.00	Easywriter II	£230.00
Wordstar	£245.00	Volkwriter	£149.00
Applewriter IIe	£106.00	Mallmerge	£140.00
Word Processing SIRIUS		Easyspeller	£115.00
Supr Calc	£140.00	Superwriter	£230.00
Multiplan	£149.00	Epson HX20	£149.00
Wordstar	£289.00	Word Processing	£85.00
Select	£285.00	M list (cassette)	£30.00
Mall Merge	£85.00	Epson QX10	£175.00
		Peach Text	£95.00
		Spell Cheker	£95.00
		Mailing List Manager	£175.00

GOODS FULLY GUARANTEED
PRICES EXCLUDING VAT AND P+P.
Company and Government orders accepted by phone.
Barclaycard Access Visa accepted by phone.
Tel.: 01-455 9823

MOUNTAINDENE
22 Cowper Street London EC2

● Circle No. 161



Ring us on 01-607 9938 for quotations on computer presentation packs and sleeves printed in one to four colours.

● Circle No. 162



REGISTERED REFERRAL CENTRE FOR THE BBC PROJECT
BEEBUG FOR THE BBC MICRO
INDEPENDENT NATIONAL USER GROUP FOR THE BBC MICRO

MEMBERSHIP NOW EXCEEDS 20,000
20,000 MEMBERS CAN'T BE WRONG — BEEBUG PROVIDES THE BEST SUPPORT FOR THE BBC MICRO BEEBUG MAGAZINE — NOW 62 PAGES INCLUDING NEW PRODUCT GUIDE SUPPLEMENT — DEVOTED EXCLUSIVELY TO THE BBC MICRO.
Programs — Hints & Tips — Major Articles — News — Reviews — Commentary. PLUS members discount scheme with National Retailers. PLUS members Software Library — a growing range of software from around £3.50 per cassette. 10 Magazines a year. First issue April 1982. Reprints of all issues available to members.

March Issue: program features: Krazy Football game, the Manhole game, requiring quick thought and fast reaction, Extending ASTAAD, our popular Computer Aided Design Program, The Stonemason, Multiple Disc Catalogues, a program version of Bach's Cantata No.147, a program for Printing Your Own Function Key Labels. Plus articles on Acorn's Latest Developments, Testing Out Your Micro (Sideways ROMs), Machine Code Graphics (part 2), Compact Function Key Definitions. Plus Reviews of FORTH for the BBC micro, Memory Expansion Board Review, Software Reviews, Hints and Tips.

Magazine programs now available on cassette to members at £3.50 inc: VAT & p+p — see April/May issue for details

April Issue: Program Features: Elevasion a fast action game, Dartboard game, with joystick or keyboard control, Domestic Accounts — Annual Budgets, for the home user, Colourful 3D Bar Charts, Indexing Programs on Cassette, a useful utility, Moving Text Display and our own April Fool program. Plus articles on Testing Out Your Micro (this month the Video ULA). Machine Code Graphics (part 3). Plus Reviews of Acorn's Teletext Adaptor, Books on Disc Systems, and the Latest Computer Games. Plus News of new products, Postbag, Hints and Tips.

Send £1.00 & SAE for Sample.
Membership UK £5.40 for six months
£9.90 for one year.
Overseas one year only.
Europe £16.00 Middle East £19.00
Americas & Africa £21.00
Other Countries £21.00

Make cheques to BEEBUG and send to:
BEEBUG Dept 5, PO Box 109
Baker Street, High Wycombe,
Bucks HP11 2TD.
Send Editorial material to:
The Editor Beebug
PO Box 50 Str. Albans, Herts.

● Circle No. 163

Making tracks

In the third article of his series on the Commodore 64 Boris Allan shows how to simulate turtle graphics.

TURTLE GRAPHICS are probably the most powerful way yet devised of using graphics on computers. Normal graphical methods use co-ordinate geometry and complex mathematical transformations to draw shapes. The mathematical techniques you need to understand even the simplest of routines can be far from trivial.

The mathematics needed to use turtle methods is simple. Pre-school children can use turtle graphics, particularly in a friendly computing environment such as is provided by Logo. All they need to know is how to turn and how to go forward.

The "turtle" of turtle graphics is either a pictorial representation of a turtle on the computer's display screen, or a device which crawls along the floor. Suppose the turtle moves on a large sheet of drawing paper, dragging a pen to draw a line. Under the control of the child the turtle moves and draws. It can also lift up the pen so that it moves but does not draw.

The turtle is really a very parochial beastie. It can only move from where it is now, and only turn at its present position. The turtle is like a car whose driver is asking for directions.

To the driver you do not say "Go to map reference X,Y"; rather you say "Go forward X miles and turn left, go forward Y miles and turn right, and then go forward another Z miles." Both sets of directions are accurate, but only the second set can be used by the driver without a map.

A child gets the turtle to draw a square by instructing the turtle to go forward a distance, then turn right through 90 degrees, and repeating that pair of instruction a total of four times. This sequence is easily understood and makes use of the internal/intrinsic geometry of a square. There are no problems with transformations to calculate co-ordinates as there are no co-ordinates.

If the child wishes to turn the square through a certain angle, then the turtle is instructed to turn to that new angle. The square is drawn by using exactly the same instructions as before. Co-ordinates are always available to be used in turtle

graphics if needed, though in fact they seldom are.

The turtle graphics system to be implemented in this article uses the multi-colour high-resolution graphics routines for the Commodore 64 given last month. There is no turtle crawling across the floor, nor even one on the screen. But the key commands are the same: Move and Turn.

In high resolution on the Commodore 64 there are three foreground colours, and one background colour. This gives the possibility of up to three imaginary turtles creeping across the screen.

Moves and turns

Each turtle has a position on the screen and it faces in a particular direction. It moves from its last position to its new position, and a way has to be provided to keep track of each turtle's moves and turns.

Arrays XL and YL contain the co-ordinates of the last place each turtle visited. Arrays XN and YN are used to find the co-ordinates of the place where the turtle has to go. Each turtle's orientation angle is stored in array AN, and the condition of each pen is stored in array PE. The arrays have three elements and the elements correspond to turtles 0, 1 and 2.

The turtle number does not appear in the initialisation routine starting at line 2000, but is known as TN. By default

Commodore Basic sets TN to 0 when the program is run.

Last and New co-ordinates for the X-axis are set to 160, and those for Y are set to 100. Each pen condition is made 1, otherwise the default value 0 would occur. The system is ready for use when the high-resolution initialisation routine for multi-colour graphics is activated.

The present turtle number is TN, the present X co-ordinate is XL(TN), and the present Y co-ordinate is YL(TN). In routine 21000 a line is drawn from these co-ordinates. The line is DI units long, and is at an inclination of AN(TN) degrees from the vertical, measured anti-clockwise.

The co-ordinates at the other end of the line are XN(TN) and YN(TN), calculated in lines 21000 and 21010: the symbol PI indicates the special Commodore 64 symbol for π , obtained by using Shift and the Up arrow. If PE(TN) is set to zero in line 21020 there is to be a move without drawing, so a jump is made over the plotting routine.

The start and end co-ordinates for the line are transferred to the correct start and end variables for the line-drawing routine. The colour code is set to one greater than the turtle number. A call is then made to the routine at line 12000.

To draw a square, initialise with
1000 GOSUB 20000

(continued on next page)

```

10 REM
20 REM GRAPHIC ART ON THE C64
30 REM
40 REM MULTICOLOUR TURTLE GRAPHICS
50 REM INITIALIZE
60 REM
70 REM
20000 DIM XL(2),YL(2),XN(2),YN(2),AN(2),
PE(2): REM COORDS, ANGLES, AND PENS
20010 FOR I=0 TO 2
20020 XL(I) = 160 : YL(I) = 100
20030 XN(I) = 160 : YN(I) = 100
20040 PE(I) = 1
20050 NEXT I
20060 GOSUB 10000 : REM INITIALIZE
GRAPHICS
20070 RETURN
10 REM
20 REM GRAPHIC ART ON THE C64
30 REM
40 REM MULTICOLOUR TURTLE GRAPHICS
50 REM DRAW LINE
60 REM
70 REM
21000 XN(TN) = XL(TN)-DI*SIN([PI]*AN(TN)/
180): REM NEW X COORDS
21010 YN(TN) = YL(TN)-DI*COS([PI]*AN(TN)/
180): REM NEW Y COORDS
21020 IF PE(TN) = 0 THEN 21070
21030 NY = YN(TN) : NX = XN(TN) : REM
SAVE COORDS FOR LINE
21040 LY = YL(TN) : LX = XL(TN)
21050 CR = TN+1 : REM COLOUR CODE IS ONE
MORE THAN THAT OF TURTLE NUMBER
21060 GOSUB 12000 : REM DRAW LINE
21070 XL(TN) = XN(TN) : YL(TN) = YN(TN) :
REM SAVE LAST COORDS
21080 RETURN

```

(continued from previous page)

choose a length of side

1010 DI = 50

and draw a line

1020 GOSUB 21000

followed by a turn of 90 degrees

1030 AN(TN) = AN(TN) + 90

So far only one side has been drawn. To draw the three other sides continue with

1040 GOSUB 21000 : AN(TN) + 90

1050 GOSUB 21000 : AN(TN) + 90

1060 GOSUB 21000 : AN(TN) + 90

If this sequence is followed it helps to understand the next, rather more ambitious, program which draws three squares, where each square is at an angle of 120 degrees to each of the other squares. The screen goes blank, then becomes yellow, and then a square is drawn. When the first square is finished, another one is started, in a different colour, orientated at 120 degrees clockwise to the first. A third square then slowly appears, at 120 degrees to both of the other squares, and in a third colour.

At program line 60, the standard turtle number TN is used as loop counter. The loop starts at 0 and steps through to 2, so that each turtle will be addressed. Each turtle is given an initial orientation of 120 degrees from each of its fellows.

The square at lines 80 and 90 is given as four separate moves. This is hardly good programming practice, and certainly not in the spirit of structured programming, but is

Three squares program.

40 GOSUB 20000 : REM INITIALIZE

50 DI = 50 : REM THE DISTANCE TO BE MOVED

60 FOR TN=0 TO 2 : REM FOR EACH TURTLE

70 AN(TN) = 120*TN : REM EACH TURTLE HAS DIFFERENT STARTING ANGLE

80 GOSUB 21000 : AN(TN) = AN(TN) + 90 : GOSUB 21000 : AN(TN) = AN(TN)

+ 90 : REM HALF A SQUARE

90 GOSUB 21000 : AN(TN) = AN(TN) + 90 : GOSUB 21000 : AN(TN) = AN(TN)

+ 90 : REM THE OTHER HALF

100 NEXT TN

110 END

unavoidable when using Commodore Basic 2. When a loop was used, such as FOR II = 1 TO 4 : GOSUB 21000 : AN(TN) = AN(TN) + 90 : NEXT II the program would not work. The error was finally tracked down to there being too many nested For loops and Gosubs for the Basic to cope.

As soon as I stopped trying to use a loop

to draw the square, and either had four separate commands or an If-Then check with a counter, the program worked — but looked far messier. Commodore 64 Basic conspires against careful programmers. The moral of the story is watch your For loops, conserve your Gosubs, and beware of such dangerous combinations, for they spell trouble.



PRINTER EXTRAVAGANZA

We challenge you to find a better deal!

Full 1 year Guarantee
NO QUIBBLE

- SHINWA CP80 (DOT MATRIX) £194 + VAT = £223.10
- EPSON RX80 (DOT MATRIX) £218 + VAT = £250.70
- EPSON RX80FT (DOT MATRIX) £247 + VAT = £284.05
- EPSON FX80 (DOT MATRIX) £324 + VAT = £372.60
- EPSON FX100 (DAT MATRIX) £437 + VAT = £502.55
- DAISY STEP 2000 or UCHIDA DWX 305
(new low cost - high quality Daisywheel) £279 + VAT = £320.85
- JUKI 6100..... £379 + VAT = £435.85
- CCP 40 (New amazing portable 4 colour printer/plotter)
..... £109 + VAT = £125.35
- DYNEER (Daisywheel DW16 Parallel)..... £299 + VAT = £343.85
- BROTHER HR15 £389 + VAT = £447.85

NEW LOW PRICES

- MT 80 (DOT MATRIX) £194 + VAT = £223.10
- OKI MICROLINES..... NEW LOWER PRICES — CALL
- FIDELITY 14" COLOUR MONITOR & COMPOSITE VIDEO
..... £189 + VAT = £217.35

MANY MORE PRINTERS AVAILABLE - OVER 200 SCI(UK) BARGAINS

SEND NOW FOR OUR FAMOUS CATALOGUE

THE FABULOUS

STAR PRINTERS



- STAR GEMINI 10x £198 + VAT = £227.70
- STAR DELTA 10 £325 + VAT = £373.75
- STAR GEMINI 15x £325 + VAT = £373.75
- STAR RADIX 10..... £499 + VAT = £573.85
- STAR RADIX 15..... £599 + VAT = £688.85

We have interfaces for all types of computers, including CBM 64, VIC 20, APPLE, TRS 80, IBM, BBC, SPECTRUM, QL, etc.

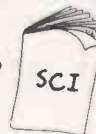

24 HOUR SECURICOR DELIVERY £9.50 plus VAT • BANKERS ORDERS, BUILDING SOCIETY CHEQUES, POSTAL ORDERS - SAME DAY
ALL ORDERS COVERED BY THE MAIL ORDER PROTECTION SCHEME • NATIONWIDE MAINTENANCE CONTRACTS ARRANGED

WE WILL MATCH ANY GENUINE PRICE. SCI(UK) IS NEVER BEATEN ON PRICE

DEALER ENQUIRIES
WELCOME
WRITE FOR DETAILS

SCI(UK)

SCI (UK) FREEPOST (No Stamp needed)
PETERSFIELD HANTS GU32 2BR

0730 63741

EXPERT ENQUIRIES
NO TAX
DELIVERY AT COST

For the lowest Prices of Printers in the UK consult this Advertisement

Now the Commodore 64 means business

The Game's over. Wouldn't you like to increase the applications potential of your Commodore 64? Transform it from a fun family computer into a truly professional tool? Now — thanks to Handic, the world's largest creator of Commodore software — you can give a powerful new dimension to your 64's performance. We have pioneered a new program called **CALC RESULT** that dramatically expands the financial planning potential of your Commodore.

Doctors, Dentists, Lawyers, Bankers, Brokers and other money managers exploit it to keep track of complex client accounts. Builders, Garage Owners, Retailers of all sizes, and

descriptions now use the spread sheet formula for instant feedback and analysis of trading results. In a world where ease of access and speed of assessment are essential, **CALC RESULT** gives everyone the power to harness the untapped potential of their Commodore.

CALC RESULT is versatile... use it to calculate loan and mortgage payments, forecast budgets, balance cash flow, monitor stocks and shares, plan personal and corporate taxation, check expenses, log and analyse all kinds of bills.

CALC RESULT instantly translates figures into multi-coloured bar charts. It has a built-in 'HELP' function and is absolutely accident proof.

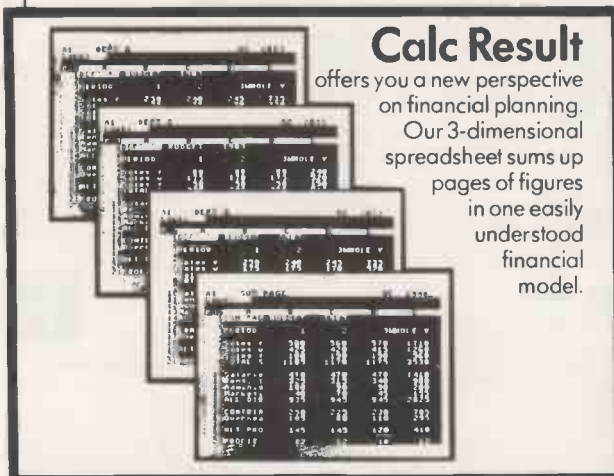

Calc Result

offers you a new perspective on financial planning. Our 3-dimensional spreadsheet sums up pages of figures in one easily understood financial model.

£99-00 (inc.VAT)



Calc Result Advanced

All functions in **Calc Result Easy** plus 32 pages (Three-dimensional viewing). Page add, window, split-screen (up to four pages on the screen at the same time), and help functions.

Delivered on plug-in cartridge plus disk. Requires disk drive.

£49-95 (inc.VAT)

Calc Result Easy

Single page spreadsheet (64 columns x 254 rows). Built-in graphics. Formula protection, flexible print-out, colour conditional functions and mathematical functions. Delivered on plug-in cartridge. Data storage on cassette or disk.



For more information contact our Advisory Centre on 0344-778800 or simply contact your local Commodore or Lightning dealer, or clip the coupon.

I would like you to send by return post further information on the PC2 Handic 64 range.

Name Title

Company

Address

Tel.

5 Albert Road, Crowthorne
Berkshire, RG11 7LT
Tel: 0344 778800 Telex: 849426

handic
software Ltd

Thinking ahead

● Circle No. 165

Deal with the experts
on Portable Computers

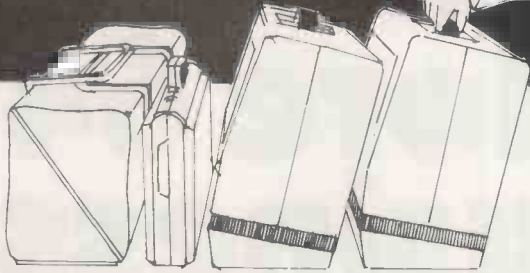

Apricot from **£1495**

256k RAM ● 315k drives

Epson HX20 **£411**

Epson QX10 Normally ~~£2594~~

Includes printer and Peachtree software
Now **£1999**

Osborne from **£945**

200k-400k per drive

FREE bundled software with every disc based system

MAY SPECIAL OFFER

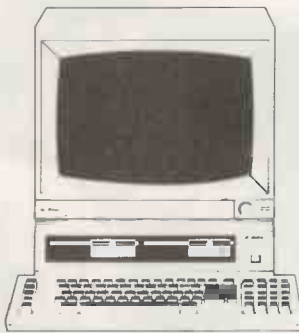

SANYO MBC 555
MS-DOS ● 128k RAM ● 160k drives
£699
MBC 550 **£899**
MBC 555 **£105**
Monitor

FREE WordStar, MailMerge, SpellStar, InfoStar and CalcStar.

Offer available while stocks last

On site training, servicing and support.

Fraser Associates Ltd.
1 Bristle Hill, Buckingham. Bucks
MK18 1EZ (0280) 816087

(0280) 816087
Call for a portable price

● Circle No. 166

Computer Enterprises

PLEASE NOTE: We believe our prices are very competitive. If you show us we will beat competitor's prices.

apricot



Apricot Twin Disks, Software, Monitor £1890
Apricot XI 5MB Hard Disk, Free Software £2695
Apricot XI 10MB Hard Disk, Free Software £2995

ACT SIRIUS 1

Sirius 1.2Floppy, 128k RAM, Software ECALL
Sirius 2.4Floppy, 256k RAM, Software ECALL
Sirius 1.2Floppy 10MB HD, Software £2950



PRINTERS

Dot Matrix
Kaoa Taxan New £279
Epson RX80 £239
Epson FX80 £329
Epson MX100FT £395
Epson FX100FT £415
EPSON DX100 ring for Best Price
Shinwa CT1 £179
Microprism £379
Prism 80S £1054
Prism 123S Colour £1195
Mannessmann Tally MT80 £259
Mannessmann Tally MT160 £489
MT Pky Plotter £485
Seikosha GP700A £379
Seikosha GP250X £199
TEC 1550 £495
Microline 92 £495
Microline 83 £445
Microline 84 £659
Microline 93 New £499
Toshiba £1395
Hermes 612B £1590
Anadex DP9725 £1255
Anadex WP6000 £1950
Anadex DP6500 New £2250
Siemens Ink Jet £545

DAISYWHEEL PRINTERS

Brother EP22 £149
Brother EP44 KSR NEW £189
Brother HR1 £995
Brother HR15 Good Value £399
Brother HR25 £675
Juki 6100 Best Seller £379
QUME 945 £1595
QUME 955 £1970
QUME 11/40 £1295
QUME 11/55 £1450
Fujitsu SP830 Fastest £1695
NEC 7700 £1675
NEC 3500 £1390
NEC 2000 £750
DIABLO 620 £795
DIABLO 630 £1760
Ricoh 1600 £1360
Ricoh 1300 £990
Ricoh 2300RP Remote £1400
Ricoh 2600RP NEW £1750
TEC F10-40 Reliable £895
TEC F10-50 £1250
Uchida DWX £355
Smith Corona TP £189
Olympia ESW103 £899
Tractor Feeds from £150
Auto Sheet Feeds from £395

IBM

IBM PC Twin disk system £1990
IBM XT 10MB HD, Software, Colour £3995
IBM DEAL: Twin disk system with printer only for £2195

Hyperion

HYPERION: Twin disks system, Software only for £2195
Hyperion Deal: WP, Data Base, Spread Sheet, Printer only for £2995

SANYO MBC550 Free software (Worth £500) ... £699
SANYO MBC555 Free software (Worth £1200) ... £899
EPSON HX20 only for limited period £359
EPSON QX10 twin disk, software £1599
EPSON QX10 with £1500 worth software £1995
HEWLETT-PACKARD 150 £2895
KAYPRO II Free software worth £1500 £1150
NEC PC Colour Display £2195
HITACHI PC Colour, 2 years guarantee £2395
PLEASE RING FOR THE DETAILS OF IBM, SIRIUS NETWORKING AND ALTOS TELEVIDEO, SAGE MULTIUSER SYSTEMS



Monitor & VDU

MONOCHROME
Sanyo SM12N (Green) £75
Philips 12" (Green) £85
Kaga 12G (Green) £98
Kaga 12A (Amber) £110
COLOUR
Kaga K12R1 £198
Kaga K12R1X RGB/PAL £239
Novex 14" RGB £229
Luxor 14" Super Res £495
Sanyo SCM14N £189
Sanyo SCM14H £399
Fidelity Best Value £180
Qume Terminals from £495
Televideo Terminals from £550
Kokusai KDS7362 £449

Software
WE HAVE 100s of Software in our list. Please call for bargain PRICES & DEMO
MAY OFFERS
Lotus 1,2,3 Powerful £259
Open Access Amazing! ECALL
Friday Easy £150
Everyman £375
Sage Plus Int. accountancy £495

EVERYTHING FOR COMPUTING

DYAN/WABASH/NASHUA/FJUI/BASF (Please ring for bargains)
Listing Papers £4 for 1000
Cables for above from £15
Dust Covers from £10
Ribbons any printer CALL
Memory Cards/Interfaces CALL
System Furniture/Printer Stands CALL
Acoustic Covers RING
Modems/Acoustics couplers RING
Photocopiers RING

HOT LINES FOR INFORMATION & ORDERS

01-542 4850 01-543 6866 TLX: 8813271

SHOWROOM

85-85A QUICKS ROAD WIMBLEDON LONDON SW19 1EX

INTERNATIONAL, EDUCATIONAL, DEALER, GOVERNMENTAL, CONSULTANT LEASE, RENT ENQUIRIES WELCOME. All items new and carry manufacturers guarantee. All goods subject to availability and price changes. Prices are exclusive VAT and Delivery.



● Circle No. 167

IN THE BEGINNING was the computer. After that came mainframes and, eventually, micros. Though dismissed as mere toys by the computer fraternity, the early micros were really all-purpose machines. Apples, Pets and Tandy TRS-80s were soon in use as home micros, and business micros, and for everything from education to automation.

Since then micros have become more specialised as more and more manufacturers have tried to find a niche for their products. We now have home micros, desk-top micros, multi-user micros, transportables, portables and even pocketables. Other machines are aimed at specific applications — games, education, graphic design, and so on.

Nevertheless, most of the world's best selling micros are still all-purpose machines. Examples are the Commodore 64, Acorn BBC Model B, Atari 800, Apple II and, at least in America, the IBM Personal Computer.

Among the micros set to join them are the Sinclair QL and the IBM PCjr. Other contenders are the Memotech MTX-500 and the long-delayed Elan Enterprise, the Advance, Triumph Adler's new Alphatronic PC, the 128K Lynx Laureate, and the 64K versions of the Dragon and Tandy Color Computer. Even the new Oric Atmos, with its real keyboard and promised disc drives, has leanings in this direction, though the metamorphosis of the Colecovision games machine into the Adam business micro is perhaps the most astonishing transformation of all.

High volume

The key point about the home/general-purpose micro is that it is designed to sell in large volumes, and this brings down the price. But it comes without a number of things that are now almost essential for serious computing — disc drives, a proper keyboard and a monitor, for example. They all form part of the true business machine.

Further, small micros are sold by department stores and national chains where the overheads are relatively low. The user often gets little more than a sealed box. By contrast, the dealer in business machines is expected to analyse a customer's business, advise on software, demonstrate everything, install the system, hold the user's hand for the first six months, and be permanently on call for repairs. All this takes the time of skilled and experienced people, and such time is very expensive. It has to be built into the selling price of the machine.

The small micro can therefore be an economical buy in some circumstances, especially for people who do not need advice and support. The intended application might not need either discs or a monitor — for example, writing prescriptions in a pharmacy can easily be done on a Newbrain, and a large number are used for this purpose. It can make more

Let's get serious

The micro is a versatile machine, so why use it just for games when it could be at the core of a practical home-office system?

sense to dedicate a cheap machine to a simple task rather than buy a multi-function business machine.

The small micro can also provide a valuable learning experience. For the newcomer, it can be useful to buy a cheap machine simply to learn about computing, rather than risk £5,000 to £50,000 on what could turn out to be an unsuitable system. After a few months with, say, a Commodore 64 or BBC Model B, the tyro will at least understand the basic concepts like size of RAM, speed of disc access and the supremacy of software. The small micro can then be sold at a relatively small loss, or used at home, even if it cannot handle the final application.

Finally, with a small micro you do not have to buy everything at once, as you do with a desk-top machine. You can start with the console, an ordinary television and a cassette recorder, adding disc drives, a printer and a proper monitor as and when funds become available.

However, truth be told, the expanded small system is likely to prove more expensive in the long run, and is unlikely to be as good as, say, a portable with bundled software or the cheaper desk-top machines. You can spend £1,000 to £1,500 and still end up with disc drives or a disc filing system that will not run the software you

want to buy, a fatiguing screen display and a keyboard that disintegrates after a few months of heavy use. Even worse, you may be trapped in a ghetto without access to the wide world of CP/M or MS-DOS software. Spend the same amount of cash on a Wren, Zorba or Philips transportable and you get more functionality.

Irresistible

Nevertheless the sheer flexibility and accessibility of a small machine can make it irresistible. You can buy a Spectrum and connect it to Prestel/Micronet for less than the cost of an RS-232C port for some business machines. You can buy two entire Commodore 64 systems — one for home and one for the office — for the price of most 16-bit desk-top micros. You can hook a BBC Model B to a DEC mini for less than the cost of a much dumber terminal. And so on.

In the following three pages, we look at the leading small micros that offer something for everyone — in the home, in education and in business. We also show how they might be expanded. The listings are not intended to be comprehensive, but they will give you an idea of what you are letting yourself in for when you buy a cheap machine. □

CP/M add-ons

The CP/M operating system, which requires a Z-80 or 8085 and 64K of RAM, still offers the best route to the widest range of serious software but not all home machines provide easy access to it.

Sinclair Spectrum. Unlikely.

Commodore 64. Now available as a cartridge plus disc. Unfortunately it is slow, offers only a 40-column screen, and does not provide easy access to standard software. However, it is very cheap at £50.

Atari 800. Standard 80-column CP/M now available with the ATR-8000; full software availability. Atari's own CP/M add-on is not yet available, but will probably tie users to Atari disc drives.

Alphatronic PC. Easy access to CP/M and existing Triumph-Adler business software.

BBC Model B. Still no sign of the Acorn Z-80 expansion, but others are available including the Torch disc pack... at a price; moderate software availability.

Apple II. Ready access to CP/M via various plug-in cards; lots of Apple-format software available.

Sinclair Spectrum

THE SPECTRUM has the largest installed base in this country and an unrivalled range of software. However the strain really begins to show in serious applications. The main problem is lack of proper keyboard, rendering it almost unusable for word processing. Even hooking up a printer and disc requires external motherboards and plug-in units. The Spectrum is a brilliant games machine, but the cost of expanding the system to a usable level is uneconomic, and the result tends to be a mess.

Possible setup

As illustrated. To run both the printer and disc drive simultaneously requires a general motherboard and two plug-in units from Velleman (U.K.) Ltd. The motherboard costs £26, the Centronics interface £31, and the output board kit £19; phone (0424) 753 246. Software: Vu-Calc and Vu-File, £9 each from Psion on 01-723 6919; The Database, The Spreadsheet and The Word Processor, £10 each from Microl. Good games: Snowman, Fighter Pilot, Manic Miner, Jet Set Willy, Atic Atac, Lunar Jetman.

Options

Prism UTAX-5000 modem, £100 from



Sinclair Spectrum 48K, £130; Viscount disc drive £199 from Spectrum U.K. on (07073) 34761; Walters printer with parallel interface, £230; Centronics printer interface and cable, £36 from Euroelectronics on (0242) 582009; and colour TV.

Spectrum on (07073) 347619, allows access to Prestel and Micronet 800. A keyboard of sorts is available from DK'tronics, £45 on (0799) 26350, but it lacks a space bar.

Software: Vu-3D, £10 from Psion, for image manipulation; Flexigraf business graphics, £10 from Saxon Computing on (0401) 50697; Figaro II database and statistics program, £15 from Saxon Computing; Comp-u-Tax income-tax package, £10 from Micromega on 01-223 7672; Comp-u-Share stocks and shares package, £10 from Micromega.

Alternative setup

Juki daisywheel printer and cable, £440 from Micro Peripherals. Otherwise there are virtually no hardware alternatives except Sinclair's Microdrive system, £50.

Software: Tasword the Word Processor, £8 from Tasman Software on (0532) 438301. Spectext WP, £10 from McGraw-Hill on (0628) 23432. Flexicalc, £10 from Saxon Software. Database, £20 from Gemini Marketing on (0395) 265165. Datagenie, £10 from Audiogenic on (0734) 586334.

Commodore 64

THE COMMODORE 64 is amazing value at discount prices as low as £190. Though not a friendly machine for programming in Basic, it provides access to a wide range of good word processors and other home and serious business software, most of which is very reasonably priced. Semi-compatibility with the old Pet series is its strong point. Its main weakness, apart from its Basic, is a lack of good original games such as are obtainable for the Spectrum and Atari micros, but for the serious minded this is not such a severe drawback.

Possible setup

Commodore 64, £230, with 1541 disc drive, £230 and Vic 801 printer, £230; all available with Easy Script, £60, as a package deal for £600. Optional Commodore cassette recorder, £45; colour display to a TV. Software: Simon's Basic, £50 from Commodore, or similar advisable if programming using sound or graphics. Easy File database, £50, and optional Easy Spell, £50; Calcsresult spreadsheet from Kobra Marketing or Handic Software on (0344) 778800.

Good games: Commodore International Football, £10, Forbidden Forest, £12.95 from Audiogenic, Caesar the Cat, £9 from Mirrorsoft.



Commodore 64 with 170K 1541 disc drive, £230; MPS 801 dot-matrix printer, £230 1701 14in. colour monitor, £230; dedicated cassette recorder, £45; Programmer's Reference Guide, £10; Easy Script word processor, £75. Plug-in CP/M cartridge also shown, £50.

Options

The normal escape route for 6502-type micros is into CP/M. However, the £50 Commodore CP/M cartridge plus disc offers only a 40-column screen and leaves you with Commodore discs. Commodore promises only "over 100 programs" of the many thousands possible. Centronics printer interfaces: £50 from Ram Electronics (Fleet) on (02514) 25252; Grappler CD, £120 from Pete & Pam on (0706) 212321.

Alternative setup

Commodore printer or Epson or similar, around £300, recommended in place of Vic 801.

Software: Magpie database, £100 from Audiogenic on (0734) 586334, and Multiplan 64, £100 from Kobra on 01-997 6666. Vizastar 64, £100, promises to combine spreadsheet, database and graphics with current Vizawrite word processor, £70; both from Viza on (0634) 813780.

Atari 800

ALL THE ATARI micros offer outstanding value for the initial purchase price. The games software is better than that for any other micro, and in range second only to the Spectrum. However, most games are American in origin and expensive, so the final cost may be very high. Beyond games there is enough software to get by, but the range is poor compared to rivals. The ATR-8000 provides a good way into mainstream computing for Atari owners who need it, but is not a cheap option for those not committed already.

Possible setup

Atari 800, £200, or 800XL, £250, with 810 disc drive, £230 and portable colour TV, plus optional cassette recorder, £50, Epson dot-matrix printer run via an 850 Interface, £135, hidden behind the disc drive. The 850 provides four RS-232C ports and a Centronics parallel port. Printer cable £25 extra.

Software: includes Atari writer ROM cartridge word processor, £60, Home Filing Manager, £40, and VisiCalc, £170.

Great games: Star Raiders, Eastern Front, Defender and Pole Position, £30 each.

Options

Joystick port to Centronics printer cables



Atari 800 setup with Epson dot-matrix printer; ATR-8000 64K Z-80 expansion running 80-column CP/M 2.2, £399 from Tollgate; connected to a standard 5.25in. drive, £200 to £250.

include the PSP-1000, £60 from Polarsoft on (0462) 54812; MK1 and MK2, £39 and £70 from Micro Research on (0506) 31603; and one from Blackthorn Electronics, £70. New Atari printers do not require an interface: 1025 dot matrix, £350; 1020 colour plotter, £200; 1027 letter-quality, £300.

Software: Letter Perfect, £110; Data Perfect, £85; File Manager 800+, £70; all from HEC on 021-643 9100. Chipsoft Business packages and Malling List, £150 each from Silicon Chip on (0753) 70639, also require Microsoft Basic, £60 from Atari.

Alternative setup

As illustrated. The disc drive reads both Atari discs and many popular CP/M formats including Osborne, Kaypro, Xerox and others. The ATR-8000's parallel printer port makes the 850 interface redundant. The Co-Power 88 card, £389/£489 for 128K/256K from Tollgate on (0582) 32752, offers a further upgrade to MS-DOS, CP/M-86 and semi-compatibility with the IBM PC. Atari has its own 40/80-column CP/M box; shown last year in prototype, on the way.

Alphatronic PC

VERY NEW to the U.K. market, the Z-80 based German-built Alphatronic PC is aimed at both the low-cost business user and the home user. There is not much doubt that the machine can deliver in the serious area, as it runs standard CP/M software and many packages originally developed for larger Adler office systems. Pricing on the serious software does not look cheap. Apart from material developed in Europe it is early days yet for games software. Triumph-Adler U.K. says it is talking to games software houses.

Possible setup

As illustrated. Available from Triumph Adler on 01-250 1717. Displays to a domestic colour TV or to a monochrome or colour monitor. Mannesman-Tally MT-80 dot-matrix printer, £260 from Data Disc U.K. on (0787) 210091.

Software: WordStar, £340. Multiplan, £224. Friday, £224. French, German or Spanish Abroad self-teach packages cost £16 on disc; Typing Tutor is £35.

Games: Dungeon Master and Rescue available at about £8 each.

Options

Second Adler disc drive £311. JVC 14in. colour monitor, £187 from Opus on 01-701



Alphatronic PC micro with 64K standard RAM, £339; disc drive with CP/M operating system, £380.

8668. Juki 6100 daisywheel printer, £314 from Data Disc U.K. on (0787) 210091. Triumph Adler says that interface boxes will be available to most of the Adler electronic typewriters, costing £50 to £100.

Software: Supercalc 2 spreadsheet program, £225. Millionaire business-simulation game, £52. ATI teach-yourself WordStar, £40. Teach-yourself Multiplan, £58. Touch'N'Go typing tutor, £29. Perfect Writer, £403, Perfect Calc, £173; Triumph-Adler may offer bundled set of Perfect packages at lower prices.

Alternative setup

Micromite adaptor, at under £100, links Alphatronic PC into Micromite local area network. You could take the system to work for use with office hard discs and printers.

(continued on next page)

BBC Micro

IN MANY WAYS the BBC Micro represents the perfect serious home micro. It is very fast, has a wide range of expansion possibilities and a very large base of serious software. However, it is expensive, limited in memory and beginning to show its age. Also officially it lacks the important Z-80 second processor. Some of these problems are likely to be alleviated when all the promised add-ons appear. The BBC machine is still a good buy — if you have the money — and is likely to be around for some time. However, its primacy will be strongly challenged by the QL — when that eventually materialises.

Possible setup

As illustrated, interfaced to domestic colour TV.

Software: View word processor, £60; Viewsheet calc, £60; Database £12; Forecast financial trends package, £12; all from Acornsoft on (0223) 316039. Good games: Planetoids, Snapper and Rocket Raid; £10 each from Acornsoft.

Options

6502 second processor for advanced applications, £199 from Acorn. The promised Z-80 unit from Acorn has still not materialised, but GCC (Cambridge) produces one for £431; phone (0223) 835330.



BBC Model B with DOS, £469; 100K Acorn disc, £265; Walters printer with parallel interface, £230, and BBC cable, £29; from Walters Microsystems International on (0494) 32751.

Grafpad graphics pad, £144, and CAD program, £21, from British Micro (0923) 48222; video digitiser and CCTV, £569 from Digithurst on (0223) 208926. Teletext adaptor for use with Ceefax and Oracle, £225 from Acorn.

Software: Statistics 1, £10 from Bridge Software on 061-427 6107. Music Processor, £15 from Quicksilva on (0703) 20169. Linkword language tutors in French, German, Spanish and Italian, £15 each from Acornsoft.

Alternative setup

With 100K discs, £245 from Cumana on (0483) 503121, or £225 from AMS on (0925) 62907; 500K discs, £230 from Opus on 01-701 8668. Juki daisywheel printer plus cable, £440 from Micro Peripherals Ltd on (0256) 3232.

Software: Wordpro, £11 from IJK Software on (0253) 55282. Spreadsheet Analysis, £20 from Gemini on (0395) 265165. Beebfile, £7 from Simon Software on (0527) 892370.

Apple IIe

THE APPLE IIe is the updated version of the five-year-old Apple II. Although the basic design is a little long in the tooth, the Apple has a vast range of hardware add-ons available for it and a huge number of Apple DOS and CP/M packages. Disadvantages are the price, which is high if you only occasionally want to use the system for serious or eccentric purposes. Although good games are available they tend to be American and disc-based, so the price is again high compared with many of the alternative systems on the market.

Possible setup

Apple Professional Home Computer pack, £873 from ATA on 01-833 0044, comprises Apple IIe, one disc drive and controller, TV modulator and various other accessories and discount vouchers. Displays to domestic colour TV or to monitor, such as Phoenix monochrome 12 in. amber monitor, £121 from ATA. Epson RX-80FT dot-matrix printer, £305, requires printer interface card, £99.

Software: The Incredible Jack, a multi-function word processing package with integrated calc and filing, £149 from Pete & Pam on (0706) 227011.

Games: Choplifter, £25, Sublogic Flight Simulator, £24.



Apple IIe with Apple single disc drive and Epson RX-80 printer, driver a domestic TV display.

Options

Alps disc drive, £159 from C/WP on 01-828 9000; Silver Reed EXP-500 daisywheel printer, £299 from C/WP, is slow but gives high-quality output; JVC 14in. colour monitor, £172 from Opus on 01-701 8668. ICE 5Mbyte hard disc, £1,450 plus VAT from Rapid Terminals on (0494) 26271. Micronet 800 package including BT-approved modem, lets you use Prestel, £148 from Telemap on 01-278 3143.

Software: Microsoft Z-80 softcard, £275 from Pete & Pam, lets you run CP/M 2.2

software such as WordStar, £339; this Microsoft card is easier to get running with non-Apple discs than some of its rivals. Multiplan, our favourite spreadsheet program, is available in both CP/M and standard Apple DOS versions for £184. Software: Terrapin Logo, £114, widely reckoned better than Apple's own Logo. Microsoft typing Tutor II, £19; Robocom Bitstik 500 graphic joystick and drawing-office software, £339; Syntauri Alpha Plus music synthesiser and keyboard, from £1,340 to £2,162; all from Pete & Pam.

NEW

For home or business the IBM compatible Advance 86^a

16 Bit Micro-Computer

Under £350*



For the home user start with Model A with its massive 144K RAM, 64K ROM and outstanding typewriter style keyboard that fits within the base unit for portability and storage.

Note the large return key and position of the numeric keyboard. Fast retrieval from storage and fast action on games is achieved by the use of the Intel 8086 16 bit micro-processor running at 4.77 MHz. The Advance 86A runs IBM PC software.

Specification

CPU Type	16-bit 8086 running at 4.77 MHz.
RAM	128K or 256K with parity plus 16K video
ROM	64K.
ROM Contents	Diagnostics, Basic, Cassette O/S
Languages Included	Basic
Type of Keyboard	Full 84 keys tactile
Keyboard Facilities	10 programmable keys
Character Set	256 in ROM
Method of Display	TV, RGB, Comp/Sync colour or monochrome monitor
Display Facilities	Full screen handling, 4 screen paged
Text	80 x 25 or 40 x 25
Graphics Resolution	320 x 200 or 640 x 200
Colours Available	16
Graphics Facilities	Scroll, reverse image
Cassette Recorder	Audio
Interfaces Included	Cassette port, light pen, joystick, Centronics
Sound	Built-in speaker
Operating System	Built-in ROM
Printers	Any using Centronics parallel interface
Comments	Hardware and software compatible with IBM PC User-upgradeable to Model B Provision for 8087 Arithmetic Processor



The business user can upgrade to Model B by adding the Advance Expansion box containing 2 x 5.25" disc drives providing 720K storage at £902.18.

The Advance 86 Model B offers the business micro-computer buyer an IBM compatible disk-based system with twin drives, with Perfect writer, Calc, Filer and Speller software (MS/DOS) for only £1250 plus VAT & Delivery.

Advance 86 Models A & B are designed and marketed by Advance Technology UK Ltd.

128K expansion £125 + VAT

Delivery within 30 days from receipt of payment.

*Ex VAT.

**Advance Technology UK Ltd.
8A Hornsey Street, London N7 8HB**

01-609 0061

To Advance Technology UK Ltd., 8A Hornsey Street, London N7 8HB

PC 2

- Please send Model 86A, Micro-Computer & Keyboard I enclose £404.99 including VAT & Delivery.
- Please send Model 86B which includes Model 86A plus Expansion Box & Software. I enclose £1250 plus £187.50 VAT plus £10 Delivery
- 128K expansion £125 + VAT

Cheque/Barclaycard/Access No. _____

Name _____ Company _____

Address _____ Address _____

● Circle No. 168

ON THE FACE of it you might think that it is a miracle that computers work at all. Faced with an incoming power supply of 240V a.c. at 50Hz they have to have a very stable d.c. supply of 0V, 5V, and probably a few other voltages as well to make them work. Due to the speed of operation of the micro the d.c. supply cannot be allowed to falter for as much as 1/1,000,000th of a second without causing problems.

One problem which can affect the power supply is radio-frequency interference, RFI. It is high-frequency interference on the mains lines and can be caused by a wide variety of things such as electric motors, and switches arcing.

Your computer will almost certainly have an RFI filter on it so depending on how bad the RFI problem is, you do not necessarily need another. Filters provide some attenuation of certain parts of the frequency band. They reduce the unwanted signal but never remove it entirely. But where RFI is bad the computer's power-supply unit may have insufficient attenuation to cope with it. In this case you might well want some more. This can be achieved in a number of ways.

Buy a box

The most usual method is to buy a box with an RFI filter in it, such as those manufactured by QED, Scilabub, Roxburgh or Valtech. The box plugs into the mains socket and the computer plugs into the box. Another approach is to replace your ordinary plug by one with an RFI suppressor built in such as The Plug from Power International Ltd.

Voltage spikes are another problem which can affect the power supply. They are fast, transient spikes of voltage which can be caused by anything from lightning to the action of a nearby switch. They can shorten the life of a computer since the capacitors and resistors — not to mention the chips — do not like having 10,000V blasted through them day in, day out.

A voltage dependent resistor or VDR can be used to combat the effect of voltage spikes. A VDR is a small device with a very high resistance within its working voltage but a very low resistance outside this voltage. A typical VDR might have a very high resistance up to, say, 640V but its resistance might drop to practically zero as soon as that voltage is exceeded. Consequently, fitting a VDR between the live and neutral terminals on the mains will get rid of spikes between live and neutral as soon as, say, 640V is exceeded by the spike.

It may not, however, mean that the computer keeps on working. One of the big problems with very fast spikes is not their amplitude, which a VDR will fix, but their very fast rise time. Most chips do their switching on the basis of a rising pulse — the leading edge of an incoming square wave. So, chopped at the top or not, once a fast-moving spike gets into the machine it can cause problems if its leading edge is mistaken by the chips as a valid signal from

Live and booting

Chris Naylor looks at the problems of keeping a micro supplied with power.

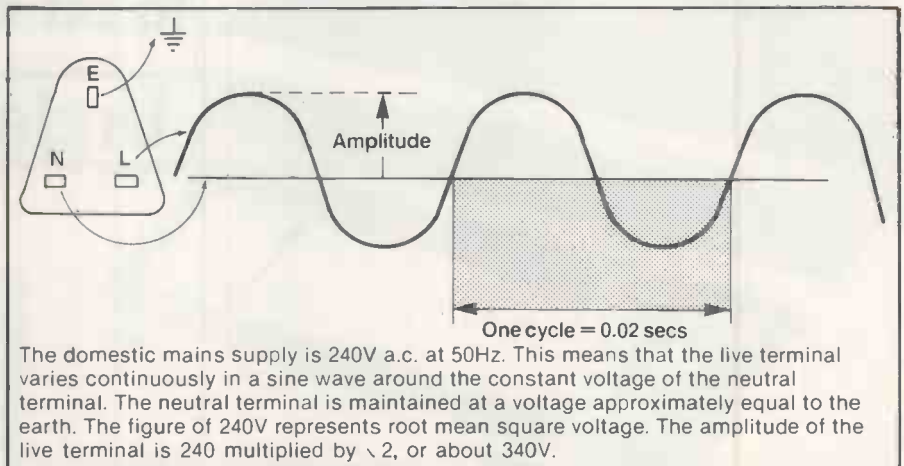

The mains is low-frequency, medium-voltage a.c. supply.

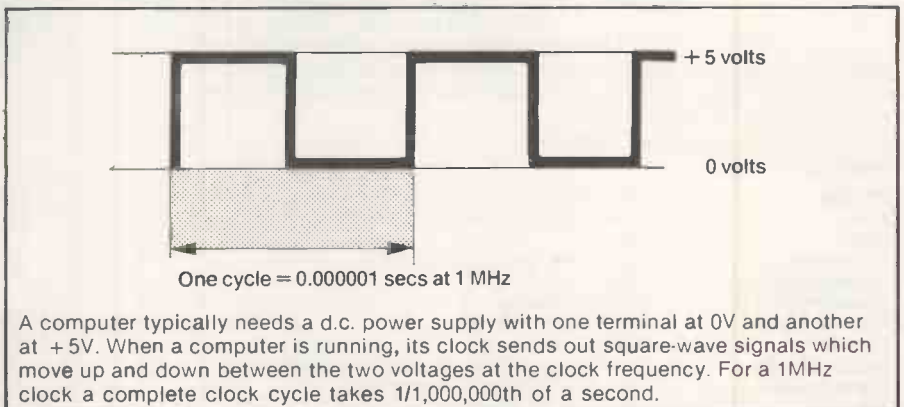

High-frequency, low-voltage clock signal.

the logic. The answer is to blur this fast edge, which you can do with an RFI.

Voltage drops or brownouts get a lot of mention in some quarters as causes of computer failure, but it would be a poorly designed power supply that could not deal with at least a moderate voltage drop. After the mains has been transformed, rectified and filtered it is passed through some kind of voltage regulator. Almost always this regulator acts by reducing the voltage coming into it until it meets the required voltage to go to the computer. So the voltage served to the regulator is normally well above what is required, which gives a fair amount of room for that incoming voltage to drop before it falls below what the regulator really needs.

A computer has no protection against

Attenuation

The decibel, dB, is the unit used to describe the attenuation of an unwanted part of the incoming signal. It is a dimensionless measure and expresses the ratio of two items. For example, if two items V_1 and V_2 differ by n decibels then

$$n = 10 \log_{10} (V_1/V_2)$$

or

$$V_1/V_2 = 10^{n/10}$$

Suppose that an RFI filter gives a 20dB attenuation of transverse-mode noise $V_1/V_2 = 10^{20/10} = 10^2 = 100$ So if V_1 is the incoming voltage before filtering, V_2 the final voltage in the frequency range being filtered is 1/100th of V_1 . A 40dB attenuation gives attenuation to 1/10,000th of the original, and so on.

voltage breaks. At the level of the motherboard, a voltage break of one clock cycle will cause the machine to fail. This does not mean that a microsecond break on the mains line will cause problems. The power-supply unit itself stores energy during each half cycle and dissipates it slowly into the system. Breaks in the mains

supply will only be certain to show up as trouble on the computer if they last about half a mains cycle, which is around 10 milliseconds.

There are two types of solution to breaks in the power supply. One is to provide cover against microbreaks and the other is to provide cover against longer failures of

power. Microbreaks can be covered fairly easily by designing a unit which has a moderately large capacitance in it to tide the machine over during breaks of a few 10ths of a second. Longer breaks require battery back-up or uninterruptible power supplies. The larger firms that operate in the fields of UPS can advise you on the right kit to keep you running under

(continued on page 119)



RFI appears as a very high-frequency component in the supply, often in the megahertz region. It can be caused by a number of things such as motors, switches and fluorescent lighting.

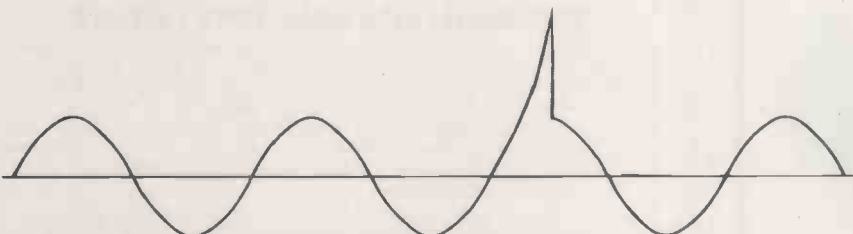

On this waveform there is a spike. This is a single pulse often lasting only a few 10s of nanoseconds but with an amplitude sometimes of 10,000V or more. The commonest cause of a spike is lightning, but it can also occur as a result of the action of a nearby switch.

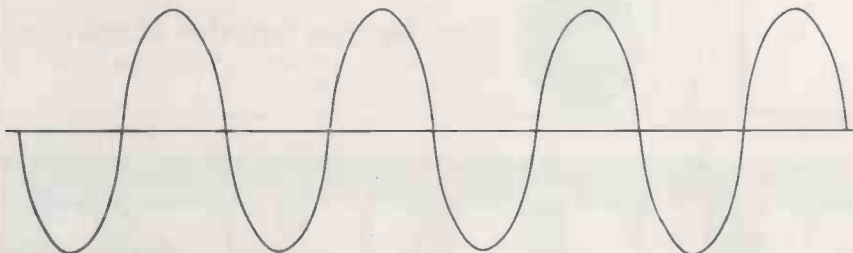

This waveform is likely to produce a voltage surge caused by an increase in the amplitude of the mains.

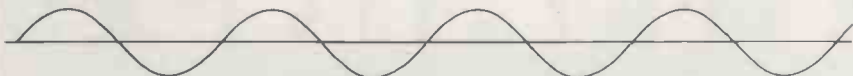

The decrease in amplitude on this waveform indicates a voltage drop or brownout.

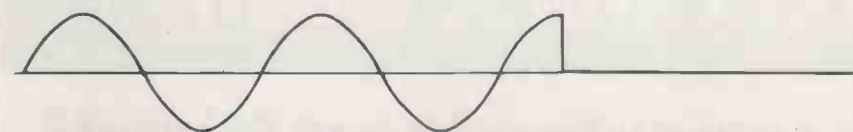

This waveform shows that the voltage has disappeared altogether. The break may last for only a very short time — a microbreak — or it may last for hours.

Five faults in the mains supply which can cause trouble for micros.

Power requirements

You can calculate the power of a d.c. device by using the equation

$$W = VI$$

where W is the power supplied in watts and I is the current.

So if a micro needs a 5V supply of 1A you need 5W to drive it. However, the power of an a.c. load is calculated according to the equation.

$$P = VI \cos \phi$$

where $\cos \phi$ is the power factor. The power factor depends on the nature of the load which is driven. Devices with electric motors in them — printers, for

example — tend to reduce the power factor. In general the power factor is between 0.75 and 0.9. If you ignore the power factor and just consider the product VI you arrive at a measure known as the apparent power of the system, abbreviated VA.

A typical micro with twin floppies, screen and printer might need up to 200W to drive it. If you have hard discs and a heavy-duty printer then these figures have to be doubled. The processing unit alone should be happy with around 100W.

Protection tree

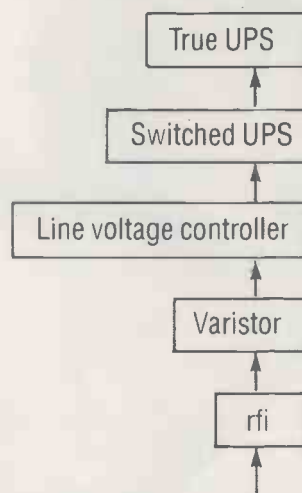

The protection tree shows the order in which you might consider mains problems. Start with RFI and fit an RFI suppressor. Progress to spike suppression using a VDR. The next stage is the line-voltage controller. It may be either a constant-voltage transformer, CVT, or an electronic line conditioner, which takes a very poor a.c. signal and provides an ultra-clean a.c. output. A good power-supply unit will not really benefit much from a line conditioner unless your mains supply is extremely bad. Uninterruptible power supplies are the final stage in the protection process and are useful if you want to keep your machine up and running when the power goes off completely. Most contain all the other protection features already mentioned.

The protection tree offers increasing degrees of insurance for your computer operations. If having your memory wiped out is no more than a minor irritation, then stay at the bottom of the tree. If it might mean that you would stand to lose 3,000 words of word-processed text which would have to be re-created from scratch and your livelihood depended on it, then you might be prepared to up the tree as far as a UPS.

Possibly the worst thing that can happen is having your main memory wiped out while disc I/O is taking place. This can corrupt the disc's directory and leave you with a worthless disc. Apart from making regular disc back-ups only sure protection against this type of problem is a UPS which gives a few minutes protection while the disc access is completed and you can store current memory on to disc in an orderly fashion. To do this the UPS does not have to serve the printer, so a small unit of, say, 120VA would do.

MAILING FLOPPY DISKS?

The Swan Disc Pack combines great strength with simplicity of use. Made from rigid white corrugated, it is a self assembly package providing high postal security at economical rates.

Free sample ring us on
01-607 9938



NOW AVAILABLE: 5 1/4" Floppy Disc Holders to fit A5 Ring Binders.

sizes:
6 x 6;
8.75 x 8.75

● Circle No. 169



WARNING: YOU HAVE DIRTY MAINS

The surges, spikes, noise and transients on the mains are a form of pollution which degrades the performance of HiFi systems and causes computers to malfunction. Protect your computer and restore the full performance of your HiFi System by fitting a Clamp 1 to the mains lead instead of an ordinary mains plug.

- Clamp 1** — Computer Grade is fitted to your computer and each peripheral, in place of the conventional 13A plug. **£4.99 each**
- Clamp 1** — Audio Grade is fitted to each component of your HiFi System, in place of the conventional 13A plug. **£7.50 each**
- Clamp 2** — Lightning strike protector. This is not fitted to any equipment, but is plugged into the mains at a vacant socket somewhere on the same ring. Protects your HiFi system, television, home computer etc. from lightning strike. **£10.50 each**

From your dealer or direct (including VAT and P&P) from:-



Russ Andrews Turntable Accessories

Edge Bank House, Skelsmergh, Kendal, Cumbria LA8 9AS
Tel: Selside (053 983) 247

● Circle No. 170

DIRTY MAINS!

a computers' worst enemy

REGUVOLT—a computers' best friend!

A 'dirty' mains supply can often jeopardise the performance of your computer, causing data loss, system crashes and sometimes, damage to both hardware and software.

Raw power, direct from the mains, is prone to transients or voltage 'spikes', which are usually caused by the variation and switching of electrical loads in the vicinity of your computer (e.g. photocopiers, lifts, domestic appliances etc.).

These 'spikes' play havoc with the mains, and then your computer suffers!

A Reguvolt Mains Conditioner will solve the problem, by providing

complete electrical isolation between the mains and your computer system. Transients are suppressed, and a 'clean' and stable voltage supply is maintained.

Where *total* mains security is concerned, a Reguvolt really is your computers' *best* friend!

Please send for further details today.

Single and 3-phase models available, from 120VA to 60kVA.



Cetronic Components Ltd.

Hoddesdon Road, Stanstead Abbots,
Ware, Herts SG12 8EJ, England.

Tel: Ware (0920) 871077 Telex: 817293

● Circle No. 171

Transverse mode.

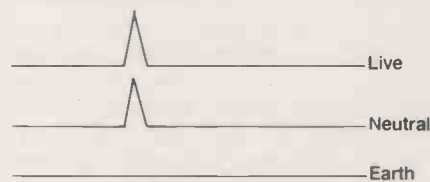

Common mode.

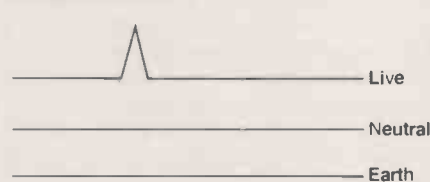

A common-mode signal occurs simultaneously on both live and neutral lines. Common-mode noise causes fewer problems than transverse-mode noise because most transformers hardly notice the signal, largely relying for their performance on the difference between the signals on live and neutral.

A transverse-mode signal is much more likely to get into the system past a transformer because the mains a.c. is also in transverse mode. You can reduce transverse-mode noise by means of RFI filters, VDRs or specially designed transformers.

Common-mode and transverse-mode interference causes different problems.



A true UPS has the battery permanently in series with the normal regulated mains supply so that the output never knows whether it is receiving battery power or mains-derived power. This avoids any possible problems associated with switching the battery in and out. Many UPS units have a CVT as their final output phase to give an ultra-clean signal.

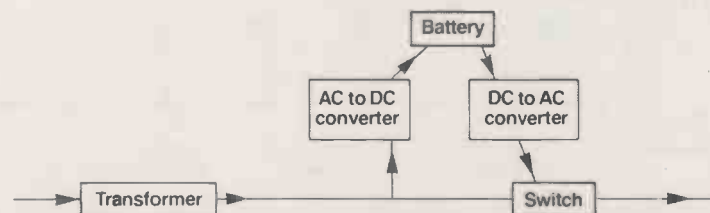

A switched UPS does not have the battery permanently with the rest of the system but only switches it in when needed. This may work as long as the switching causes no interference to the supply. The danger is that the delay in switching will be excessive, or that the act of switching will put a spike and/or RFI on the line, thereby knocking out the system.

Uninterruptible power supplies.

RFI AND SPIKE SUPPRESSORS

Alan Kiddle MF10A, MF25A, MF30A RFI filters and VDR spike suppressors. MF10A rated at 10A and comes in standard plug-in box; £79. MF25A rated at 25A is wall-mounted; £128. MF30A rated at 30A and has an earth-leakage circuit breaker; £198. Alan Kiddle Associates Ltd, Fairlight House, 729 London Road, Hounslow, Middlesex TW3 1SE. Telephone: 01-543 0179.

Cetronic Ltd NPT Noise-protection transformers rated from 250VA; £150. Cetronic Ltd, Hoddesdon Road, Stansted Abbots, Ware, Hertfordshire SG12 8EJ. Telephone: (0920) 871077.

Instelec INS 011, INS051, INS101, INS201 RFI filters rated from 1A to 20A packaged with flying lead connections; they need to be wired in. Instelec Ltd, 715 Hockley Centre, Vyse Street, Hockley, Birmingham B18 6ND. Telephone: 021-236 1103.

MPL Power Systems Clean power plug Modified 13A plug with RFI suppressor and VDR built-in, rated at 6A; £29.50. MPL Power Systems plc, Bilton Way, Hayes, Middlesex UB3 3ND. Telephone: 01-848 9871

Power International The Plug Modified 13A plug with RFI suppressor and VDR built-in; rated at 4A; £15.50. Power International Ltd, 2A Isambard Brunel Road, Portsmouth, Hampshire PO1 2DU. Telephone: (0705) 756715.

QED Audio mains interference suppressor Plug-in box with RFI suppressor rated at 750W, £15.99; and 1,500W, £20.75. QED Audio Products Ltd, Ashford Industrial Estate, Shield Road, Ashford, Middlesex. Telephone: (07842) 46236.

Roxburgh Suppressors LF13, LF134 RFI suppressor and VDR spike suppressors in a plug-in box, rated at 13A. The LF13 has one outlet, the LF134 four outlets; £33.95. Roxburgh Suppressors Ltd, Eagle Road, Rye, East Sussex. Telephone: (0797) 223725.

Russ Andrews Clamp 1 A 13A plug with VDR spike suppressor fitted; £4.99. Russ Andrews Turntable Accessories, Edge Bank House, Skelmergh, Kendal, Cumbria LA8 9AS. Telephone: (053983) 247.

Scilabub Scilabar 1, Scilabar 3 Scilabar 1 is a VDR spike suppressor for insertion into any socket on a circuit; £18.50. Scilabar 3 is an RFI suppressor and VDR spike suppressor in a plug-in

(continued from page 117)

almost any circumstances imaginable.

However, to get a better supply to your computer you must consider the whole environment as regards the electricity supply within which the machine works. For example, when installing a UPS you could have one for the computer, one for the printer and one for the screen, but it would make better sense to save money and have one unit which covered the whole lot. The one thing you have to think about is the circuit from which all of these items are driven. If the power supply on that circuit is good then the power supply to each item on that circuit is good.

Consider a typical ring main running around in a loop from the junction box and back again. If you fit an RFI suppressor at the exit from the junction box on the ring-main then all of the items following the suppressor on that circuit will be protected. Similarly, a VDR, constant-voltage transformer or uninterruptible power supply fitted at this point will provide protection throughout the whole of the circuit. So by attacking the problem at source you can fix all of the problems with a single device.

The disadvantages of doing this are that the devices will need to have a greater power-handling capability. On that single circuit you might well have a couple of electric fires as well, so you might need devices with a power-handling capability in the 3kVA range, which proves very expensive.

A secondary disadvantage is that if there is some interference present it may not originate before the junction box. For example, a poorly suppressed piece of electrical equipment such as a hair dryer

(continued on next page)

box; £47. Both feature test buttons and when the VDRs fail still provide power and sound and alarm. Scilabub Ltd, Unit 1, Workspace 17, Highfield Street, Coalville, Leicestershire LE6 2BR. Telephone: (0530) 812385.

Valtech Plastics mains filter RFI suppressor built into four-way distribution unit, rated at 3A; £47. Valtech Plastics Ltd, Castlegarth Works, Thirsk, North Yorkshire. Telephone: (0845) 22184.

LINE VOLTAGE CONTROLLERS

Advance Electronics GT104, GT204, GT304, Mainstay Constant-voltage transformers with a high specification. GT104 rated at 100VA; £99. FT204 rated at 200VA; £128. GT304 rated at 300VA; £159. The Mainstay is rated at 150VA; £79. Advance Electronics, PO Box 230, Wrexham, Clwyd LL14 3JR. Telephone: (0978) 821000.

Avel-Lindberg MP3, MP4 Line conditioners designed to provide clean 240V a.c. power from a d.c. source such as 24V batteries. The MP3 costs £250, and the MP4 £785. Avel-Lindberg Ltd, South Ockendon, Essex RM15

(product list continued on next page)

(continued from previous page)

can generate a lot of RFI. If this device is plugged into the circuit after the protection devices then the interference it causes will not be suppressed and your efforts will have been wasted.

The trick is to place any protection devices as far back in the circuit as possible so that they cover all of the items which need protecting, and far enough forward in the circuit so that any interference to the supply occurs before them. This way you get the maximum amount of protection using the minimum number of devices. One easy way to achieve this is to plug the protection devices into one wall socket and add a mains distribution unit to give several outlets, one for each piece of kit that needs protecting.

Troubleshooting

Identifying the source of trouble can be something of an art. But you can often get a clue by noting anything else which is switched on, or has recently happened, at the time when your computer fails. Is the immersion heater or refrigerator switched on? Also note whether failures occur at any regular time of day. Is it when the local factory starts work? Is it when a train goes past? Is it on hot summer days when there might be lightning around?

In general, if you trace the problem to airborne interference the cause is something you cannot suppress and the interference is so strong that it is being induced directly into the computer. The answer is to place the computer into a tightly fitting metal box and to earth the box. This may make it hard for you to get at the keys, but it will work. It is possible to

coat plastic cases on the inside with a paint containing zinc particles, which goes a long way to providing protection while preserving the nice appearance. Apart from protecting the computer from interference, this also protects other devices from the interference caused by the computer, which can itself be a powerful source of RFI interference.

You may feel that your mains is just not all it might be. If so, the local electricity

board will come out and check it for you for about £10 — or for free if you have just moved into the premises. This check covers the supply voltage and the earth continuity. Alternatively, you could check these things yourself using an a.c. voltmeter between live and neutral to check the voltage and an ohmmeter between the earth on your computer and, say, a cold water tap to check that the earth lead is actually connected to earth. □

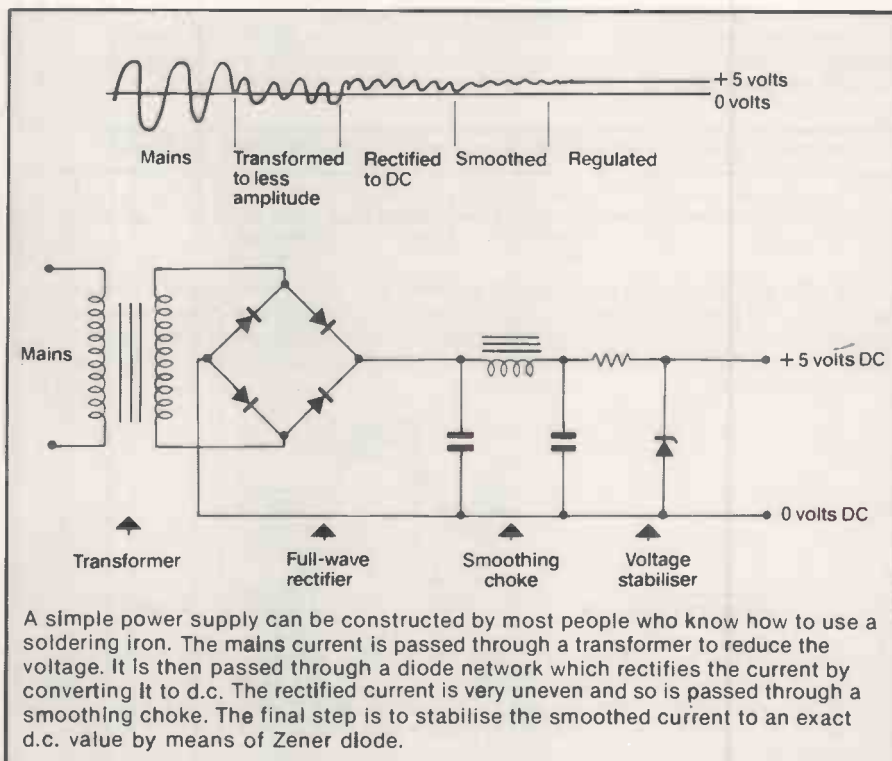

Producing stable, low-voltage d.c. from the mains supply.

5TD. Telephone: (070) 885 3444.

Cetronics Reguvolt D Constant-voltage transformers rated from 120VA to 1,000VA; about £130 to £330. All come as plug-in boxes. See previous entry for address.

Claud Lyons Stabilac Electronically controlled line voltage conditioners, a large range rated from 150VA upwards, all come as plug-in boxes; from £150. Claud Lyons Ltd, Ware Road, Hoddesdon, Hertfordshire EN11 9DX. Telephone: (0992) 467161.

Microguard CVT250, CVT500 Constant-voltage transformers. CVT250 rated at 250VA; £195. CVT500 rated at 500VA; £295. All come as plug-in boxes. Microguard, 24 Foregate Street, Worcester WR1 1DN. Tel: (0905) 21541.

MPL Power Systems Series 6 power conditioners Electronically controlled line voltage conditioners rated from 1,000 VA to 5kVA. All come as plug-in boxes. See previous entry for address.

Sola Banner Sola Constant voltage transformers available rated from 70VA to 2kVA. The smaller units offer 70VA, 140VA, 250VA and 500 VA; from £100. All come as plug-in boxes. Sola

Banner (Europe), 28 Lurke Street, Bedford MK40 3HU. Telephone: (0234) 40094.

UNINTERRUPTIBLE POWER SUPPLIES

Avel-Lindberg KD-1 A 1,000VA UPS available either as a true UPS or a switched UPS which can be configured to a wide range of specifications including the option to switch to an alternative power source; from £3,050. See previous entry for address.

Centronic micro UPS An extensive range of true and switched UPS units rated from 250VA up to 30kVA; from about £1,000. The micro units have built-in batteries with 15 minutes backup. See previous entry for address.

Compec Systems A 250VA unit is under development, aimed specifically at the IBM PC. Compec Systems Ltd, Welton, Brough, North Humberside, HU15 1PT. Telephone: (0482) 666624.

Eccleston Electronics Battpower True UPS rated 180VA, giving back-up time of 70 to 420 minutes; £440. Rated 300VA gives back-up time of 45 to 210 minutes; £767. Rated 600VA gives back-up time of 15 to 20 minutes;

£2,500. Eccleston Electronics, Eccleston & Hart, 8 Legge Lane, Birmingham B1 3LG. Telephone: 021-236 6220.

Microguard EPU200, EPU500 Switched UPS units rated at 200W and 500W. The EPU 200 gives backup time of 120 minutes; £395. The EPU500 gives a backup time of 90 minutes; £795. See previous entry for address.

MPL Power Systems Mini Processgard True UPS with sealed-in batteries. Rated from 100VA giving seven minutes backup time; £438. Extra battery packs are available at an extra cost of over £300, to extend backup time up to 120 minutes. See previous entry for address.

Power Testing The Power Bank True UPS with sealed-in batteries. Rated at 120VA giving backup of 60 minutes; £373. Rated at 250VA giving backup of 43 minutes; £511. Rated at 500VA giving backup of 36 minutes; £917. Power Testing (Sales) Ltd, 65a Shenfield Road, Shenfield, Essex CM15 8HA. Telephone: (0277) 2333188.

Sola-Banner Mini-UPS True UPS. A large range of units starting at 300VA giving backup of 25 minutes; £1,000 plus. See previous entry for address.

Would you like to have Power?

While all the rest are in the dark.



Meet the
**POWER
BANKS**

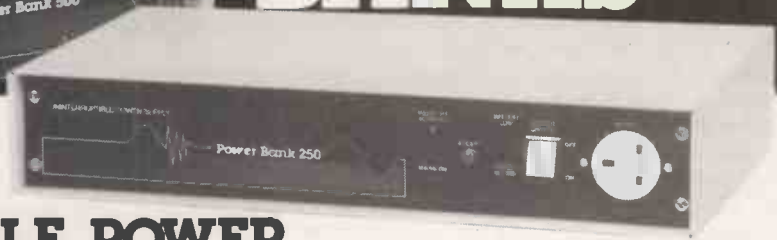

THE UNINTERRUPTIBLE POWER SUPPLY systems that are the complete answer to **ALL** of your problems!

With the POWER BANK "BLACK OUTS" will not affect the operation of your computer system. Micro Systems, Networks, Hard Disks, Printers, Telephone Exchange, Data Transmissions etc.

- * Output derived constantly from self contained sealed for life batteries.
- * Sine wave shaped output – voltage and frequency closely regulated.
- * Genuine "NO BREAK" unit with continuous output ratings of 500-250 & 120VA.
- * Much more than a "spike and surge" suppressor.
- * Far superior to a voltage stabilizer.
- * Overload and short circuit (output) indication and protection.
- * Bench or rack mounting (500VA).
- * Battery level monitored – mains on – mains off indication.

could you bank on that much power ?

MANUFACTURED BY:-

Power Testing (Sales) Ltd.

23 Tallon Road, Hutton, Brentwood, Essex CM13 1TE
Tel: Brentwood (0277) 233188. Telex 24224 MONREF 586

● Circle No. 172

Each time he fired, an enemy died. His face wore an impassive blankness as his fingers, barely moving, operated the controls of his machine, but his eyes were filled with resolve and dedication. He knew the end was near, but his gaze did not wander from the screen to the portentous fuel gauge for an instant. That would mean missing a target, wasting a round. He never wasted a round. To shoot was to destroy.

The fuel ran out. The shrill sounds of the warning filled his ears as the controls froze. His last missiles smashed into the target ships, blowing them into incandescent fragments. For a while the screen was clear, then two enemy ships popped out of hyperspace ahead of him. One flashed across his field of vision; Starfiend's finger touched his fire button automatically and the ship ceased to exist. Meanwhile, the other accelerated along a wide curve, clear of his field of fire. It was going to ram him. They wanted him that badly.

The screen blazed blue-white, and the echoes of the explosion chased each other up and down the arcade. Starfiend gurgled in delight and, in answer to the machine's prompt, entered his name. It appeared, in coruscating letters, at the top of the screen while below it the machine proceeded with the important business of enticing the next client.

As Starfiend turned to leave, he bumped into the man who had been watching over his shoulder. Starfiend had not seen him arrive but such had been his concentration that this did not surprise him. "Sorry," he mumbled cursing the tongue, which seemed like a roll of carpet and which made his life a misery. He knew that the man would not understand him.

"That's alright, son," replied the man. Starfiend gasped inwardly at his error. Normally, if strangers bothered at all they could only understand him with persistence and repetition. The man continued, "I've been watching you, and I'm very impressed. You must have put in a lot of practice." He paused, inviting a reply.

Starfiend wriggled in inner conflict. Experience told him to escape, before the innocent conversation became an embarrassing trap for them both, but curiosity and excruciating loneliness urged him to stay. "No," he ventured, the word rolling off his tongue like a sticky clay ball. The stranger raised his eyebrows in interested astonishment. Emboldened, Starfiend continued: "They moved this machine in on Monday. That was the fifth time I've played it."

The stranger nodded. He had understood. He scrutinised the machine's score chart. The top five entries were Starfiend's, and his lowest score was twice that beneath it. "They'll never grow rich with people like you about," he quipped, then added less gently, "Shouldn't you be at school?"

Horror and suspicion flooded Starfiend's mind. Was the stranger a school inspector; a truant hunter? Brazenly, he responded, "Yes. Right now, I should be attending a music lesson. The music teacher likes choral

Starfiend

work. Not much point me being there, is there?" The last sentence was spoken in a bitter tone.

The stranger looked thoughtful. "You don't like school?"

"I would if it liked me."

"Have you considered a special school?"

"I have; but my parents think that I'm better off with 'normal' boys."

"So you come here to avoid school?"

"No!" Starfiend was adamant. "School's unpleasant; and there I'm average to poor. But here, I'm king. The arcade owner never turns the machines off, so my name's on top of all their lists. I don't want them to know who Starfiend is. I know, and that's all I need."

The stranger nodded, as if he had heard something he already knew. "Are you

by L S Murray

going back to school now?" he asked. Starfiend nodded. The stranger continued, "May I walk with you?"

They left the arcade and made their way down the High Street, a canyon of corrugated iron and plywood made both colourful and seedy by a profusion of posters advertising gigs and wrestling matches. For a while they strolled, silent amid the mid-morning noise and fumes, then the stranger remarked, "Have you ever wondered how those machines work, Starfiend?"

"Microprocessors," replied the boy, instantly realising that the word was a meaningless reflex action. "No, I guess not. I asked my physics teacher once, but all I got was a load of chat about energy gaps and conduction bands."

"I'm surprised you remember those terms."

"Once I learn to say something, I don't forget it."

The stranger flushed. "I'm sorry."

"It's alright, I didn't mean it like that." Actually, he had, but Starfiend felt ashamed of his petulance. New friends were not to be treated so badly. "Tell me," he asked, "how do microprocessors work?"

"I don't know. I'm not a scientist, I'm a soldier. No, the reason I brought the subject up was to point out a curious anomaly. Does it not seem strange to you that developments in electronics over the past few years far outstrip those made in other fields?"

"Do they?" said Starfiend. As if cued, two sports cars leapt away from the nearby traffic lights, their exhausts bellowing and tyres squealing. They raced neck and neck up the hill and were lost to sight.

"Take those cars," said the stranger.

"They have components made of advanced steel alloys, and electronically controlled engines, yet they are based on principles known to the Romans; hot gases expand. But they are grossly inefficient. Don't you think that in 2,000 years something more elegant could have been contrived?"

"Like what?"

"I told you, I'm not a scientist. But where I come from, we have engines as far in advance of those cars as they are in advance of Newcomen's. That, and a thousand other wonders, such as my presence here."

"Where do you come from?" Starfiend felt cautious. He was not afraid; if the stranger intended him harm, he could have done so already. Perhaps he was insane. Yes, that was it.

"I will tell you in a minute. First, though, let me ask you this: how is it, do you think, that I am able to understand you so easily?"

"I don't know."

"Perhaps this will make it clear."

For a second Starfiend wondered what he meant. Then it dawned on him; the stranger had not moved his lips. He had not spoken the last sentence.

"Telepathy," thought Starfiend aloud. His immediate reaction was one of relief. He had been subconsciously puzzled by the ease with which he and his friend could communicate and, above all, he knew that he could rest his aching tongue. Suspicion came next: "How much can you see?"

"Only what you want me to. Others I know can see more, but they don't look without reason."

"What's it like?"

"Seeing. Hearing. Touching. But there are drawbacks. Consider those cars we saw. If I tried to drive one through your traffic, I would be dead before the day was out. My reactions are four times slower than your people consider normal — 12 times slower than your own."

Starfiend was pleased by the indirect compliment. He noticed on reflection that the stranger's gait was rather ponderous.

The stranger continued, "So we read minds. Those who are born without the ability can be cured. The reaction speed we can do nothing about."

"Please tell me where you're from," begged Starfiend.

"Try a guess."

"I suppose the chances of a race from another planet looking exactly like us are negligible. I doubt that a country of telepaths could remain undiscovered. That only leaves one possibility."

"You're right. I'm from your future. Your scientists know that time travel is possible, but they shrink from the consequences . . ."

"Which are?" Starfiend had already discovered that interruptions were much easier in telepathic conversation, in fact almost unavoidable.

"Effect without cause. Call it backwaters in time, if you like. It's no more difficult a concept than Einsteinian relativity would have been to a contemporary of Galileo."

"But what about all the objections? Like killing your own father before you were conceived?"

The stranger laughed. "You might cause yourself to cease to exist. Or not. Or you might not be able to kill your father, no matter how hard you try. In any case, don't let it bother you. Time travel is possible. The space-time continuum can be changed, but it is elastic, and changes tend to smooth themselves out eventually."

Questions whirled in Starfiend's brain. The stranger answered them. "Yes, we still have weapons, and wars to be fought with them, although not amongst our own kind. Far, far in the future. No, we don't use our control of time against our foes, since to do so might provoke retaliation that could destroy everything. Everything! Neither do we or the enemy allow artificial minds to fight for us."

He saddened, and answered Starfiend's last question. "Yes, we are losing. That is why I'm here."

"Your telepathy is useless in war, and your slow reaction speed leaves you at a disadvantage. Why don't you send computers to fight your battles for you?"

"Because that would start an uncontrollable race which would lead to sentient machines — sentient creatures — being created to destroy each other. Neither us nor the enemy are that dishonourable."

"Then change your reactions."

"We cannot. We no longer have the necessary gene pool. I have come to get those genes."

Starfiend knew then that he should wake out of what seemed to be a dream, or be terrified, but neither happened. Instead, he quivered with excitement. "And the arcade games? Microelectronics?"

"Screening machines. Presents from us to you, given through the minds of your engineers. I know you want to come, Starfiend."

"My family . . ." hedged the boy.

"I can make it as if you have never existed. There will have been a minor disturbance outside your house the night you would have been conceived. You will become a backwater in time."

"Truly?"

"We cannot lie with our thoughts, my friend."

"Alright." Instantly, Starfiend felt a wrench within his stomach. A car moved 10 metres forwards instantaneously; a piece of paper at their feet vanished. Throughout the world, similar trivial changes took place. Starfiend's parents had a new son who was normal in every respect, and they were happy.

"Ready?" said the stranger. Starfiend

noded. They turned into the vandalised doorway of a shop, where a dazzling bluey purple ball appeared at stomach height. It dilated into an ellipse as large as a man. Through it, Starfiend saw his first glimpse of the land where he would be a hero.

The time traveller grasped his wrist firmly but gently. "You can still go back," he said. Starfiend shook his head vigorously. "Mind the edges, then," said the time traveller.

They stepped through.

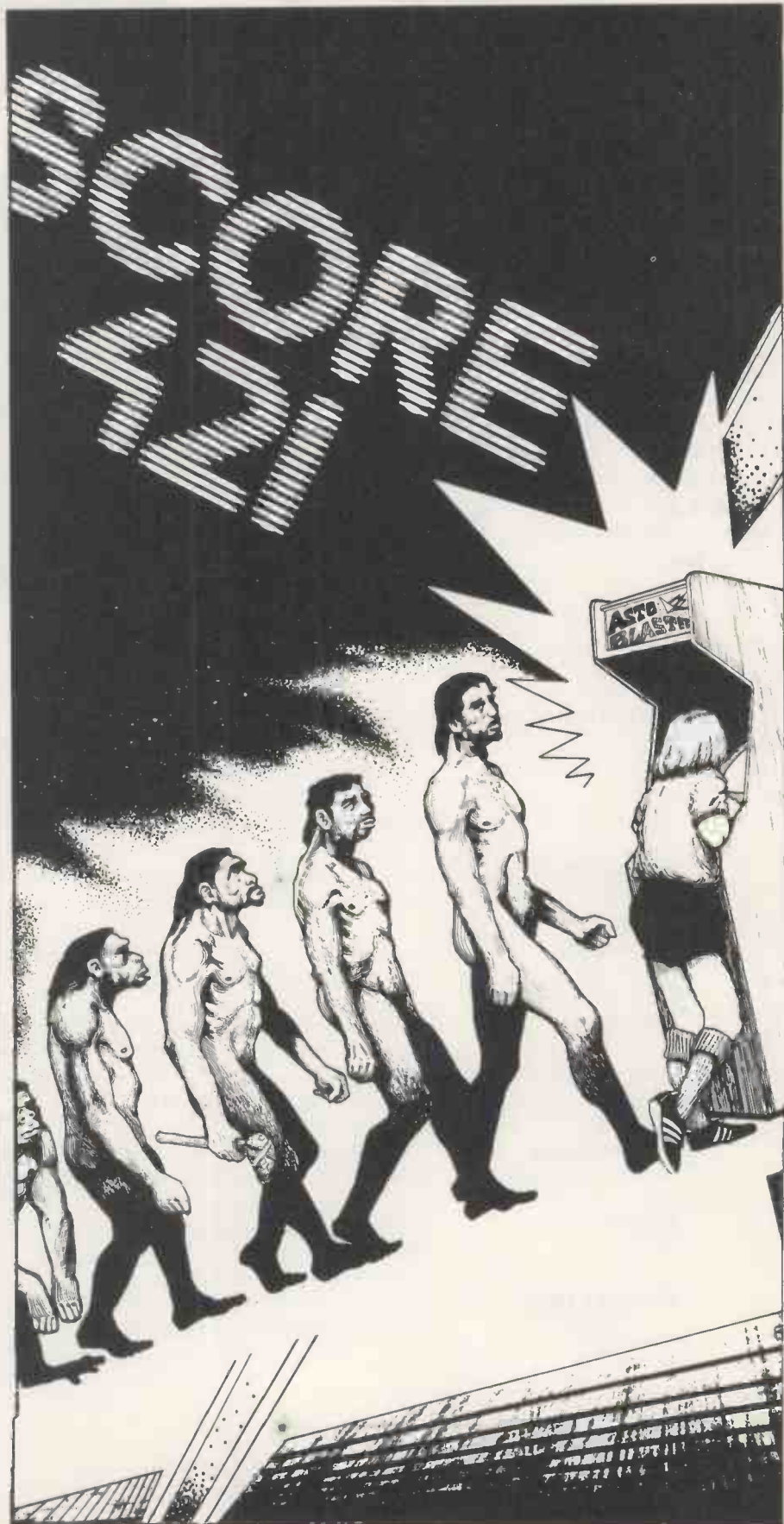

CFACC

The Best Accounts Programme on the Market

AVAILABLE FOR:

GENERAL TRADERS
MANUFACTURERS
RETAILERS
SOLICITORS
CAR SALES
GARAGE FORECOURTS
ARCHITECTS
POINT OF SALE

SINGLE OR MULTI-USER

ARABIC VERSION AVAILABLE

MAIN MENU	
1 Address Section	Stock Reports 16
2 Sales Invoices	VAT Statements 17
3 Purchase Invoices	Purchase Ledgers & Daybook 18
4 Delivery Note Entry	Sales Ledgers & Daybook 19
5 Purchase Order Control	Ledger Code Print 20
6 Payments Made	Capital Assets 21
7 Payments Received	End of Month/Year 22
8 Record Alteration	Accountants Section 23
9 Creditors	Payroll Section 24
10 Debtors	Bank Reconciliation 25
11 Supplier Statements	Profit & Loss Account 26
12 Customer Statements	Balance Sheet 27
13 Agent Statements	Management Financial Reports 28
14 Customer & Supplier Index	Change Disks 29
15 Depending on Version	Finish Using CFAAC/ Make Back-up 30

OPTIONAL EXTRAS:

JOB COSTING
INDEXED STOCK
MULTI-CURRENCY
FIFO STOCK CONTROL
MULTIPLE DISCOUNTS
& PLUSSAGE
INTEGRATED CREDIT
CONTROL LETTERS
SALES ORDER & BACK ORDER
CONTROL
INCOMPLETE RECORDS

THE SOFTWARE

'CFACC' is rapidly becoming the industry standard – the one others are judged by. Prove this by seeing the others first – BUT DON'T COMMIT YOURSELF.

'CFACC' has been tried and tested the hard way, over the last 3 years by real customers in a real business environment and many modifications have been incorporated as a result of the feedback obtained.

REAL INTEGRATION

'CFACC' is designed and written as a complete integrated system. It is not a collection of individual programmes joined together.

COMPATIBILITY

The data file written by 'CFACC' are in a format which can be accessed by other programmes such as WordStar.

THE USER

Most people can effectively use 'CFACC' after one day's 'trial and error' without even having to refer to the comprehensive Users Manual. You only need to enter invoices, payments and receipts for 'CFACC' to produce everything on the Main Menu.

THE HARDWARE

'CFACC' can be supplied for any 8 BIT or 16 BIT microcomputer with a CP/M 86, PCDOS or MSDOS operating system and a minimum of 64K RAM.

PRICES

From £1,250 for our small business version and from £1,650 for standard "CFACC".

AVAILABLE FROM

Our main distributor, "M.E. Marketing Ltd" 9, Woburn Street, Amphill, Beds. 0525 404262 and from approved dealers.

For further details, take the logical step and contact

MEM Computer Systems, 9 Woburn Street, Amphill, Beds, MK45 2HP. Tel: 0525/404262

Happiness is a shared file

The word "integrated" sells software. In this special 13-page feature we look at what this term means and at whether what it describes is worth having.

IN THE LAST YEAR there has been a strong move towards software that can share data with other applications, or software packages that combine several functions. These are integrated packages. Integration simply meaning combining isolated parts into a more useful whole.

As hardware has improved, integration has become a more achievable goal. Most integrated systems require plenty of memory and often high-capacity disc drives. But top-end hard-disc based products like Visi On and the Apple Lisa have encouraged other software writers to look anew at what is possible on more affordable equipment.

More and cheaper

The Incredible Jack provides integrated word processing, filing and spreadsheet analysis on floppy-based Apple II and IBM PC systems. Vizastar claims to do the same for the floppy-based Commodore 64. It seems likely that the coming year will see integrated packages for an increasing number of low-cost machines.

No one wants to type in data for a spreadsheet and again for a word-processed report which needs to reproduce part of a spreadsheet table. Data integration is the minimum that qualifies a package or range of packages as integrated, but it is surprisingly difficult to achieve fully. At the lowest level it means the ability to read files produced by another package.

An early attempt at integration was Dif, the data interchange format used in VisiCalc, which specified not just the raw data format but how field attributes should be represented. The writers of VisiCalc went on to produce a whole range of different applications which could swap data between them.

Many present-day packages have this level of integration. We have called these packages integrated suites. They are really sets of separate but matching programs which can share data, but each application is distinct. The advantage is that if you only want to do word processing, mailing and spelling checking but not record keeping or spreadsheet analysis you only need buy the applications you want. The disadvantage is

generally that each package works rather differently, so the user has to spend time learning how to use each one.

Multi-function packages like Lotus 1-2-3 or The Incredible Jack take integration a stage further. The standard word processing, spreadsheet, filing and sometimes graphing functions are all provided from one large package. This provides an opportunity to make the package easier to use. To the ability to pass data between tasks is added a more consistent set of commands across the range of tasks the package is capable of.

Lotus appears to the user as a spreadsheet with built-in text editing and graphing functions; Jack seems like a word processor that can file and handle tabular data. The limitation of this multi-function approach comes when you want to add an application not allowed for in the original design.

The next step is the fully integrated environment, seen on systems like the Macintosh, Lisa, Xerox Star and Grid. Here, development of the integrated software starts with the native operating

system of the machine, and works up through software tools such as on-screen window managers and virtual-memory managers to the application level. This allows the advantages of the multi-function approach to be combined with the flexibility of the integrated suite approach in adding new applications.

Standards

What most users really want is to be able to transfer data, with its structure undamaged, to a completely unfamiliar application running on a completely different brand of machine. Documents can already be moved by public-access electronic-mail systems such as Telecom Gold, but there are limitations. If, for example, you wanted to transfer the contents of a Lisa-generated report across to a distant Sirius you could probably do it, but would have to sacrifice all but the straightforward text. A full solution to this problem requires not one but a hierarchy of standards governing data representation and hardware. □

Types of integrated software



Integrated suite



Integrated environment



Integrated accounts



Multi-function package

Integration ranges from a linked suite of programs to a full Lisa-like environment.

Keep it in the

MOST MICRO USERS need to be enthusiasts. As well as having to put up with expensive, limited hardware, they have to adapt their methods of working to a hotch-potch of different software packages, each requiring memorisation of its own repertoire of commands and control sequences, and storing data in its own unique format.

As an answer to the charges that they have no common standards, the software houses are offering collations described as "integrated software suites of advanced management tools". So now you have the Star family from Micropro, the Perfect family from Perfect Software, and the Super family from Sorcim, to mention but three.

Generations

Like human families, they are made up of a mixture of generations. Typically a single product leads the way into the marketplace, with others — sometimes bought in from other software houses — added later to fill any gaps. Perfect Writer, originally pioneered by Mark of the Unicorn, is the father of the Perfect Family; Supercalc, now upgraded to versions 2 and 3, heads the Supers, and the grandfather of the Stars is good old reliable WordStar.

There is even a solution for users who have bought a disparate collection of packages from different software houses and are wondering whether to throw them all away and start again. Micropro sells a front-end called Starburst, Alpha Micro markets DBM II, and there is Menu-manager from Graham Dorian Systems and Menumaster from Borland. They are all menu-driven batch control systems that

allow dealers, or users with time to spare, to set up a simple press-button interface that short-cuts the strings of operating-system commands needed to evoke each package individually.

The Perfect family of software represents a relatively modest attempt at integration, but is typical of what manufacturers feel able to achieve. It has been built around a set of common concepts: data stored as ASCII, multiple buffers, virtual-memory architecture, mnemonic control command structure and transient menus.

The standard Perfect family consists of Perfect Writer, Perfect Speller, Perfect Calc and Perfect Filer, and appears as a bundled package on a number of micros. If you are running an IBM PC you can add the Perfect Link communications package to this suite. Perfect Link can talk down simple cable connections and phone lines to other computers, and can also persuade IBM drives to behave as if they belonged to other machines like the Epson QX-10, the NEC 8001a, or double-density Osborne drives.

Perfect Writer was reviewed in the February 1983 issue of *Practical Computing* and is chiefly remarkable for its ability to juggle up to seven separate files at the same time, making it simple to refer to one file while writing another, or to transfer paragraphs from file to file. The screen can be split into two parts, each displaying a different buffer. With Perfect Writer comes Perfect Speller, a spelling checker that uses a not entirely foolproof algorithm-based dictionary equivalent to 50,000 words. The dictionary looks at the roots of words rather than whole words, and so is blind to typos like conditionion,

and mistakes that jam legitimate roots together to form meaningless words like undion.

Unlike WordStar, Perfect Writer stores all its text as true ASCII so there are no tricky high bits set at the end of words, or soft Carriage Returns that make a mess of the screen when typed out directly. This philosophy is also fundamental to Perfect Calc and Perfect Filer. Admittedly, ASCII format is not the fastest or the most compact way of storing data, and is particularly unusual in a Calc, but it simplifies data transfer for the programmer. There are advantages for the user too. Perfect Calc keeps all its functions in a function library which is also stored in ASCII format and is accessible for change or extension, although the manual is taciturn about how to do this.

Calculating

The multiple buffering principle is carried over effectively into Perfect Calc. Most Calcs allow you to split the screen so that you can see various parts of the same spreadsheet at the same time. Perfect Calc goes a step further by allowing each part of the screen to be a window on a different buffer, and there can be up to seven files active at any one time. This makes it very easy to do calculations across spreadsheets, comparing, for example, company budgets for this year, last year and next year.

If necessary most Calcs can write out standard ASCII files, but Perfect Calc stores its formulae plus row and column settings as a listing of the keystroke sequences needed to set up the file. All numbers are stored in the ASCII representation of a 13-digit mantissa and a

The Star set

WordStar The old word-processing warhorse. Not the best, nor the easiest to use, with a quirky non-ASCII way of storing data, but still a bestseller.

Wordmaster A text editor that is a subset of Wordstar, designed for use by program developers. Little known in this country.

Starindex An indexing and section-numbering system for WordStar files.

Mailmerge An additional overlay for WordStar that allows variables in text files to be filed at print time either by strings or by the contents of whole files.

Spellstar Another add-on to WordStar that checks your vocabulary against a 20,000-word dictionary with U.S. spelling. If you call up the S option from WordStar without Spellstar on-line, an error message announces that it comes in a separate file.

Datatar A forms-creation and data-entry system.

Supersort A very fast, very comprehensive collection of sorting routines. Can cope with the standard Star file format and many others.

Reportstar A program that allows you to design print reports from data files created to the standard Carriage Return delimited format.

Infostar Datatar and Reportstar bundled together.

Starburst A menu-based front end for Micropro and other application programs.

Calcstar A fairly rudimentary Visi clone.

Planstar An advanced spreadsheet and business planner with sensitivity analysis and backtracking that can produce bar and line graphs. Like Perfect Calc it uses virtual-memory techniques to permit a maximum spreadsheet size of over 32,000 cells. Too new to assess, but at £500 it had better be good.

There are plans to run all these programs eventually on all the popular operating systems, but at the moment the newcomers Starburst and Plancalc are only available in this country for the IBM PC.

family

Chris Bidmead assesses some software suites to see if they are a real asset to the micro user or just a cosmetic marketing effort.

two-digit exponent, which guards adequately against rounding errors. But this degree of accuracy, which would conventionally need only 32 bits, requires 18 bytes.

For this reason Perfect Calc's spreadsheets break no records in loading time, but on the other hand they do allow for a great deal of flexibility in the way they can be manipulated outside the Perfect Calc environment. For example, spreadsheets can be set up and edited in Perfect Writer, or be modified by data called in from the Filer. Spreadsheets can also be transmitted over modems with no need to be translated into an intermediate transmission format like the DIF format used with VisiCalc.

No short cuts

Perfect Filer is a conventional flat-file management system. It would be undistinguished as a product on its own but works well with Perfect Writer, although there are no short cuts for moving data.

The first hint that the programs of the Perfect family do not understand one another as well as they should comes when you configure them for your terminal. Setting up Perfect Writer is a complicated business, but that is only reasonable considering the power of the program. But when you come to set up Perfect Calc, instead of a simply running a routine to look at the configuration file created when you installed the word processor, the spreadsheet installation program takes you through the whole procedure again.

Peachtree Software offers its own basket of "five important office productivity tools" under the name of Peachpak. Components are

- Peachcalc, a standard Visi clone.
- Business graphics, a menu-driven graphics generator for the screen, printer or plotter, with a repertoire of 10 different types of chart. It links primarily to Peachcalc.
- List manager, a simple flat-file management system for generating mailing lists and labels.
- Spelling proof reader, a typo catcher based on an expandable 20,000 word dictionary.
- File converter, a VisiCalc to Peachcalc and WordStar to Peachtext reformatter. Peachpak does not include a word processor — you have to buy Peachtext separately — but the six are all supposed to work together.

Sapphire Systems is a British software company known in the micro market for its

financial planner, Mars, but it is working hard towards an ambitious suite of integrated programs that it hopes to have ready by the beginning of next year. The company's first step has been to add a database manager called Datamaster, which is linked into Mars by a conversion routine that uses Mailmerge-type ASCII intermediate format. A similar link to the company's accounting package, Sun, is currently being built. The same conversion routine is used in the upgrade path from Sapphire's £49 Calcmaster.

Sapphire recognises that integration is a much abused word in software, and admits that its own offering constitutes integration of a very rudimentary kind. But rather than disguise the joins with a cosmetic front end it is putting all its efforts into a revision of the programs themselves. A new version of Mars, written in C instead of CBasic, will integrate properly with Datamaster, and with a word processor as yet unnamed which is to be added at end of this year.

To supply at least a cosmetic sense of integration, Micropro recently introduced a front end to all its packages. Starburst allows menus to be set up to drive applications packages — and not only those from Micropro — either directly or by way of decision-making batch files. This isolates the user completely from the operating system and from irrelevant details of the application packages that are being driven at the time.

This may help make a disparate bundle of applications programs look more like a coherent system, but without a standard for passing data it is not true integration. But the separate Micropro packages are all capable of using the same ASCII Carriage Return delimited data format, with commas and sometimes double quotes enclosing fields.

Double keying

The standard Micropro packages listed in the box use this format to pass data between them, but the process is by no means automatic. WordStar can create a Carriage Return delimited file to be read by Mailmerge, for example, or speed up the process of entry by creating the same file as a series of Datastar records. Calstar can also create a similar file, but is not able to read it in. So records inside Datastar have to be keyed in again if you want them in spreadsheet form.

Such rekeying is what integrated software is designed to avoid. The recent launch of Planstar aims to put this right. Planstar is an upgrade of Calstar that adopts virtual file techniques to add

sophisticated features like sensitivity analysis and linear projection.

Supertools is the collective title of four programs from the Sorcim Corporation. Supertools also denotes a separate front-end package that offers menu-driven entry to the other programs and controls a temporary file, known as the scratch pad, which is used to transfer data between programs.

Supertools

Supertools includes one or two utilities of its own, and can act as a kind of shell to MS-DOS, driving commands like Del, Ren and Chkdsk in a friendly and accessible way through simple menus. Configuring Supertools for a particular system is only a matter of editing a text file called Super.fig, which contains data concerning which drives particular files are going to be kept on, which function keys should operate which commands, and what is to be displayed on the screen.

The four advanced management tools that Supertools has at its fingertips are

- Superwriter, an easy-to-use word processor praised for its simple and direct command style. A Superwriter two-key sequence can usually accomplish what it takes three or four keys in WordStar to do. It includes a spelling checker based on an expandable 20,000-word dictionary.
- Supercalc 2, an upgraded version of Supercalc, reviewed in the May 1982 issue of *Practical Computing*. It now includes a date data type that lets you calculate the number of days between dates to identify overdue accounts, and can also consolidate data between separate spreadsheets.
- Superplanner, a desk-top organiser that works like an animated diary.
- Supercomm, a communications package to tap into phone networks by way of a modem.

Superwriter is worthy of mention on account of its auto insert mode that lets you edit by overwriting until you reach the space character that terminates the word, whereupon insert mode is entered automatically. Superwriter is a step up from WordStar, avoiding WordStar's insistence on a different type of marker for the beginning and end of a block. Supertools automates the moving of data between Superwriter and Supercalc 2 by way of the scratch pad, to the point where you only have to press a function key a few times, but this is still an action the user has to carry out explicitly. □

BY THE TIME this issue of *Practical Computing* hits the streets, the QL should already be in the hands of the lucky few. Such is Sinclair's latest promise, which some people will believe when they see it. One thing that is around and running is the software from Psion.

Admittedly this preview is not based on hands-on experience — it was claimed that the pre-production QL used to show off the software was too fragile for the likes of journalists to use. Moreover, Microdrives were conspicuous by their absence, fuelling speculation that there are problems with this storage medium; instead the programs were loaded from plug-in ROM boards.

Psion has been isolated from the development and production problems of the QL by its decision to write all the software in highly portable C on a Vax minicomputer. When this is cross compiled, little modification is required to adapt a program to run on a particular processor. Psion further eased implementation by using software emulators of particular machines to enable most problems to be sorted out in a hardware-free environment.

Altogether 16 programmer-years have been devoted to developing the software suite, which offers four main applications: spreadsheet, word processing, database and business graphics. It has been licensed to Sinclair, not sold. Psion retains the copyright, and aims to release versions for other leading machines in due course.

Spreadsheet

The spreadsheet package, Abacus, represents an advanced piece of programming relative to other current products. The main screen is divided into three areas. At the top is the control area, which contains prompts for further inputs and lists the function keys.

In all the applications packages, pressing F1 provides extensive Help listings which typically occupy about 20K. The Help pages are usually nested. At each level subsidiary screens are called up from a list of options displayed on the screen. Passage back up the tree is via the Return key, marked Enter on the QL.

Beneath the command area is the main window on to the spreadsheet. At the bottom of the screen is the status area, displaying the current cell, the extent of the spreadsheet, contents of the current cell and the memory remaining expressed as a percentage. The status area is common to the other application packages as well.

Another feature common to all four packages is the line editor. Holding down Shift with the Cursor Left and Cursor Right keys moves one word at a time. Using Control with the Cursor Left key deletes the character situated to the left of the cursor; using it with the Cursor Right key deletes the character lying under the cursor. Otherwise the line editor is in insert mode.

Abacus follows the usual formats of other spreadsheets. Figures are entered

QL quartet

Glyn Moody reports on the software being bundled in with the new Sinclair micro.

directly, and text strings prefaced by ". Up to 64 columns and 256 rows are available, although it is not clear how much memory will be required to store this size of sheet. In addition to the usual alphanumeric label — A1 for top left-hand corner — text entered

as a column heading or row label may be used to refer to a cell. For example, in a financial spreadsheet with a row marked Sales, and with columns headed by the months of the year, it is possible to move to the cell containing July's sales figures

HELP press F1		Amend Copy	Echo Files Grid	Load Merge Order	Quit Rabout Save	Window Xecute Zap	COMMANDS press F3 ESCAPE press ESC
PROMPTS press F2		Design	Justify	Print	Units		
A	B	C	D	E	F	G	H
Softoo Budget Exercise 1984						Thousand pounds	
	January	February	March	April	May	TOTAL	
1 Sales	134.88	140.78	147.74	155.12	229.19	2132.90	
2 Direct Costs	87.18	91.46	96.83	100.83	148.97	1386.38	
3 Gross Margin	46.98	49.25	51.71	54.29	80.21		
4 Rent	3.67	3.67	3.67	3.67	3.67	44.04	
5 Rates	2.58	2.58	2.58	2.58	2.58	30.88	
6 Electricity			9.43		9.43	37.72	
7 Telephones		3.28				12.80	
command>							
F1: ALL		EXTEND 017		130.71 53%			
F2: sum(ALL:NULL)							

The Abacus sheet divided into two independently scrolling windows.

HELP press F1	PROMPTS press F2	Type to insert at Press ENTER for new para Delete: SHIFT KEY & ← Change mode: SHIFT KEY/F4	COMMANDS press F3 ESCAPE press ESC
	move ← with ↑ keys ↓	press F4	press F5
London Hill.			
Dear John,			
Re: 37, Baldock Street, NHI			
I enclose a cheque for £136.45 for searches that you have carried out on this property. I note that the property is owned by Milharbour Estates Ltd. and I would be grateful if you could approach them on our behalf.			
We are prepared to offer up to			
MODE: INSERT STYLE:	WORDS: 65	LINE: 21	PAGE: 1
		DOCUMENT: "default.doc"	

Quill maintains a continuously updated word and line count.

simply by pressing F5 followed by

```
jul.sal;
```

Word order is unimportant, and it is not necessary to enter the full name of the rows or columns.

The power of the labelling device extends even further. It can be used to manipulate the information contained in the rows and columns simultaneously. For example, you can calculate the costs if you know the monthly sales figures. Say,

$$\text{costs} = \text{sales} * 0.43 + 169$$

You can enter such a formula as a command in the row labelled Costs. The appropriate figures for each month are then calculated and entered across the columns by the program automatically. The figures contained in labelled rows and columns can even be multiplied together.

Other facilities include string concatenation, and the ability to enter Escape characters into cells. Such features taken together with more standard ones like replication and statistical functions make Abacus a very powerful spreadsheet, and the 68008 processor means that it is also very fast.

With Quill, Psion's word-processing program, the company has opted for a middle course between detailed WP power, as exemplified by WordStar, and a system that is easy to use but limited in its facilities.

Like Abacus, Quill has a control area where all prompts appear and the function keys are listed. At the bottom of the screen the status area records the number of words entered, the line and page number and the name of the current document. Information is also given on the mode, which can either be insert or overwrite, and on the style, which includes options such as bold, subscript and superscript. Styles are changed using F4 followed by the appropriate single-key command. The central area of the screen is reserved for text entry.

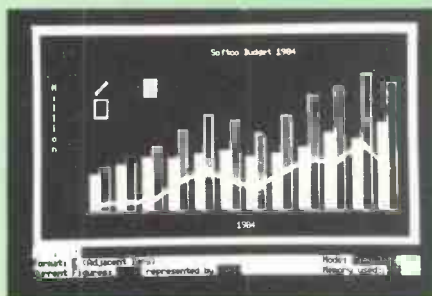

Bar and line graphs combined in a single Easel display.



Simple commands can be used to retrieve files in Psion's database Archive.

Text is entered with normal wordwrap. The line-editing facilities found in Abacus are supplemented by an overwrite mode, whereby additional text replaces rather than adds to existing text. Psion has made a neat distinction between single and multiple word insertions. Adding a single word causes the text which follows to shift along and re-form in the usual way.

For large-scale insertion this becomes trying on the eyes as large blocks of text are shunted along and continually reformatted. In Quill, the addition of more than a single word causes a line to split at the point of insertion. Extra words can then fill the blank space so created without further reformatting. Adding letters to a word which is a subscript causes those letters to appear in subscript too.

Standard function

Most of the standard word-processing functions are available, generally via the function key F3 and the relevant single-letter command — M, for example, calls up the Margin command. The cursor position is then used to relocate any or all of the left, right and paragraph indent margins. In addition, left, centre, right and decimal tabs can be set up. Blocks to be moved or copied are defined using the cursor. The search-and-replace facility tackles one word at a time, and requires confirmation for each replacement.

Quill is sensibly implemented, and works well considering the constraints imposed upon it by the command structures. Further, the major facilities missing, such as mail merging and a spelling checker, are currently being developed.

The power of the 68008 processor only really becomes apparent in the business graphics package, Easel, which allows line, bar and pie charts to be drawn. Once more the screen layout is divided into three areas. The control area lists the roles of the first three function keys, as well as giving details on how to enter text and formulae.

The main portion of the screen normally displays a blank co-ordinate grid, with default labels of x-axis, y-axis and title. Cells along the x-axis are labelled with the months of the year; the y-axis runs from 0 to 10.

Colour plays an important role in screen layout. The main grid is red on a black background, and the surrounding borders are green. Superimposed on the grid is a pair of white cross wires. They are used to select the relevant cells when entering data or text. The cross wires are moved along from month to month by pressing the Tab key, and data is entered directly by keying in the figures and then pressing Enter. The graph is quickly plotted and if the new value exceeds the previous maximum y value, the whole graph is rescaled to accommodate it.

After the graph has been built up it is possible to add text anywhere on the grid. The cross wires can be scrolled smoothly in both horizontal and vertical directions

using the Cursor controls. Text is entered by prefacing it with ' or ". The text can be repositioned by moving the cross wires, which carry the text with them. Pressing Enter when the required point is reached releases the text and switches off the cross wires.

New graphs can be built up by means of the Newdata command, accessed using F3. Before entering more data, a name must be given to the new set. A blank grid appears, and figures can be entered for the second graph. It is possible to create a further graph using the information contained on existing graphs. For example, you can create a graph called Profit, which is obtained from the relation

$$\text{profit} = \text{sales} - \text{costs}$$

where sales and costs are two previously graphed sets of data. It is also possible to display several graphs on the same axes using commands initiated by F4.

The graphs are produced very quickly and make striking use of colour. Although there are a number of command screens that allow specific details of the bar or pie charts to be altered, these are almost entirely cosmetic changes such as shading. Easel provides most of the facilities necessary for business graphics and is very easy to use. The graphs are limited insofar as they are tied to the month-by-month structure and the one-year range; day-by-day analysis is not possible.

The QL software quartet is completed by the database package Archive. To provide the additional facilities for customisation, Psion has developed a powerful procedure-driven language whose syntax closely resembles that of SuperBasic, the QL's new structured Basic.

Archive can be used as anything from a low-level card index up to an advanced intelligent database. The power of this programming tool is bought at the price of a rigid syntax, typical of any higher-level language. The manuals are, however, helpful in dealing with this.

The extent of integration between the programs varies. Apart from Archive, the command structures are integrated to a high degree, which allows a user to pass from one to another with relative ease. The integration of data is more limited. Import and Export options permit data to be transferred between the business graphics program, Easel, and the spreadsheet and database programs.

Since the system seen for this preview was ROM-based and without Microdrives, it was not possible to gauge the extent of compatibility between applications using this process. There is no integration between the word-processing package Quill and other packages.

In addition to full software support from Psion, membership of the QL owners' group, QLUB, entitles users to future upgrades of the QL packages. Even without these, many people will no doubt find the whole package sufficiently attractive to make all that waiting worthwhile.

A disc a day

Jack Schofield checks out some of the multi-function packages on offer to see how well they meet their "do everything" brief.

TURN ON the computer, boot a single disc, and use it all day: that is the ideal held out by multi-function packages. One program should be able to do word processing, filing, spreadsheet calculations, graphing and, if possible, communications. It would be better still to have a program that not only did everything but did it without the need for a special environment, expensive hardware add-ons or a multi-tasking operating system.

So many software writers have had exactly such thoughts that multi-function packages are now appearing by the score. Open Access, The Incredible Jack, Jane, T/Maker III, Encore, Knowledge-man, Symphony, MBA Context Oman, Vizastar, Supercalc 3, Integrated 6 and many more. They do not all do everything — in fact, most only do two or three things really well. Nor do they all do things in the same way. However, the power of these programs is increasing rapidly, and the viable all-in-one package could be very close indeed.

Silicon Office

The whole process started in 1981 with Silicon Office from the Bristol Software Factory. Here was a program that did word processing, database management and communications. It could also be configured to handle virtually any application, including stock control, payroll and the usual business ledgers. It was truly a miracle of its time, and the new 16-bit version has by no means been overtaken by recent American offerings.

Silicon Office had the ability to have six files open at once, and when word processing could handle 160 A4-size pages, using virtual paging. However, there were limitations. It did not run on everyday hardware, only on the 96K Pet, the 8096. It was an expensive package at £800, and it is not cheap even today. It was also rather slow. Even so, it represented a milestone in the development of integrated software.

The subject has returned to the limelight recently because of the huge success of a single package running on a single machine: Lotus 1-2-3 on the IBM PC. Viewed from the relative quiet of the U.K. it is hard to see what the fuss is about. Lotus 1-2-3 is mainly a spreadsheet that does graphs, though it also has a fairly primitive data-handling system. Yet at £375 it is far from cheap for a super spreadsheet, particularly as it needs either a colour graphics adaptor and colour monitor, or a Hercules card before it will display graphs on the IBM PC.

Probably the real significance of Lotus 1-2-3 is not its integration but two other factors. First it really is easy to use considering it is such a powerful package, which is important for newcomers to computing. Second, it was launched with massive advertising, which is nowadays even more important than the quality of the product.

The success of Lotus has brought forth a plethora of Lotus-eaters — programs that do as many, if not more, things as Lotus, and often about as well, if not better. Supercalc 3 is a good example of a similar product, a spreadsheet with built-in business graphics and limited data-

handling facilities. Encore and Context have gone further but in a similar vein. Encore offers a report-writing feature, and Context can word process up to five pages of text in a single cell. Lotus, in reply, is readying its own do-everything package, which is not called 4-5-6 as you might expect, but Symphony.

However, not everyone wants to start from a spreadsheet, and other packages have taken different approaches. Knowledge-man, for example, offers two distinct modes: a database and a spreadsheet. The data-handling facilities are very powerful, being derived from MDBS from Micro Data Base Systems Inc., but the spreadsheet is no more than accomplished. Three additional programs can be linked to Knowledge-man, namely K-text, K-graph and K-paint, providing even more of a total environment.

Apple programs

Of the programs more orientated towards word processing, like the original Silicon Office, the most interesting are Jane and The Incredible Jack. A special feature of these is that they run on the Apple II. Jack is promised for the IBM PC, and Jane for the Commodore 64, Atari 800XL and other small machines as well as the IBM PC.

Jane is a thoroughly contemporary package in using icons, windows and a mouse. On the demo disc we received the program has three distinct parts: Janewrite, Janecalc and Janelist. Electronic mail will be available at a later date.

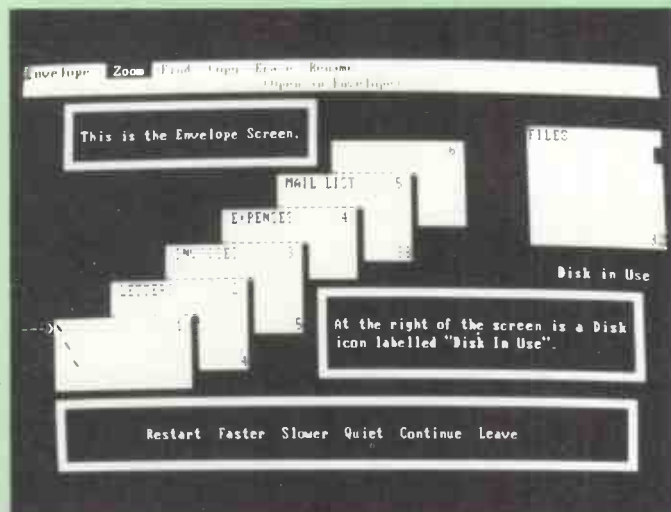

Jack 2 uses icons for user friendliness. This photo is taken from the tutorial disc, hence the help messages.

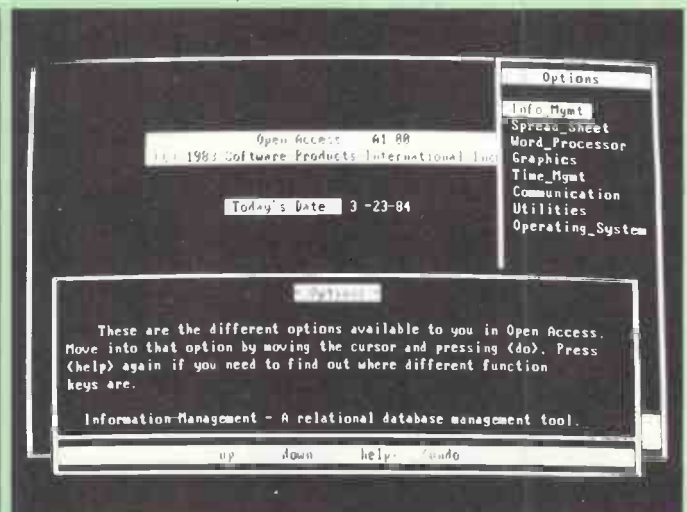

Open Access uses windows. Here the options and help windows have been called up.

Each function can be called into a window on the screen by selecting the appropriate icon, and each function seems easy to use. Using the mouse, a set of figures from, say, the spreadsheet, can be selected and transferred to a letter — a sort of cut and paste. But real life is rarely as straightforward as a demo disc, and the degree of interaction between the programs will remain a mystery until Arktronics launches the actual program.

The Incredible Jack has been available on the Apple II for a few weeks and is already gathering an enthusiastic following. The IBM PC version is expected shortly, but it was "expected shortly" last February too.

No windows

Jack does not use windows nor does it offer a "desktop metaphor". Instead it allows word processing, spreadsheet calculations and graphics on the same screen, in the same document, at the same time. You can use the screen as you would a sheet of paper, creating your own spreadsheet and drawing your own graphs. There is no preordained arrangement of cells as in a normal spreadsheet. So commands do not take the form

A3 = A2 - A1

but

Margin = Sales - Costs

Graphing facilities are limited to point and bar charts.

Underneath Jack is a filing system, which can be displayed visually as a series of 50 envelope files. Pointing to a file enables you to look at the forms inside it. It seems fast and efficient, though it does not qualify as a sophisticated database.

Amazing!

Jack is undoubtedly incredible. For example, it is possible to include spreadsheets and graphs inside a form letter, and have these filled in from the filing system. It also handles multi-column word processing with ease. Otherwise, if your requirements are not too complicated, this program comes about the closest yet to offering everything in one package and on one disc.

There are still limitations. If you want a more sophisticated type of chart. The

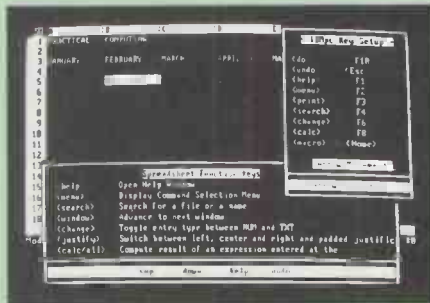

Open Access has a standard spreadsheet, shown here with help windows.

Incredible Jack cannot handle it, so you may be driven to another package. Also, you might want to add a different kind of program entirely, and that presents problems.

Integrated packages like The Incredible Jack and Lotus 1-2-3 are excellent when they do what you want. When they do not you may be forced back to separate applications packages, or constructing what you want with, say, dBase II. However, there is an alternative: the integrated environment.

Disc changes

Open Access and Visi On are huge do-everything programs which use multiple windows and present themselves as integrated packages. Both programs work in essentially the same way. A monitor program controls the whole operation while calling individual programs to perform specific tasks. Ending one program automatically boots another, though this may require a change of disc. It may be relatively easy to transfer data from one function to another, but both are really suites not single integrated packages.

Thus Open Access and Visi On are not particularly different from running any suite of programs under a common shell program. The Micropro range under Starburst, for example, or a mixture of packages under the DesQ program from Quarterdeck are quite similar in practice. □

	Word processing	Spreadsheet	Graphics	Database	Comms	Notes	Runs on	Price	Importer or supplier
Encore Ferox Microsystems	*	***	***	*	N	Enhanced spreadsheet with modelling and report writing	IBM PC, Sirius 1	£375	Dataflex 01-748 4176
Jane Arktronics	***	**	—	**	N	Uses icons, windows, mouse; claims to be easy to use	Apple II (so far)	\$295	Arktronics (Paris) 522-15.15
Knowledgeman Plus Micro Data Base Systems	***	***	***	***	TBA	Suite of Knowledgeman plus K-text, K-graph, K-paint	K-graph for IBM PC Only; otherwise MS-DOS, CP/M-86	£450- £725	Tamsys (07535) 56747
Lotus 1-2-3 Lotus Development Corp	*	***	***	*	N	Powerful and user-friendly; reviewed in PC, January 1984	IBM PC, Wang, DEC, TI; Sirius in U.S. version only	£375	Lotus (0753) 840499
MBA Context 2.2 Context Management Systems	*	***	***	*	Y	Big and not easy to use	IBM PC, etc. under UCSD-p	\$695	Context (California) (213) 378-8277
Oman Graffcom Systems	***	***	***	***	Y	Large environment; includes diary, phone book, etc.	PC-DOS, MS-DOS, CP/M-86 and Concurrent CP/M-86	£495	Graffcom Systems 01-385 9422
Open Access Software Products International	***	***	***	***	Y	Large environment with 3D graphics; on two ds/dd discs	IBM PC	£495	Softsel 01-844 2040
Silicon Office v.2 Bristol Software Factory	***	—	—	***	Y	Also accounts; links to Lotus 1-2-3	IBM PC, DEC Rainbow, Sirius 1, Apricot	£790	Bristol Soft. Fact. (0272) 735022
Supercalc 3 Sorcim Corporation	—	***	***	*	N	Enhanced spreadsheet; part of a suite including Superwriter	IBM-PC, Sirius 1, Apricot	£295	ACT Pulsar 021-455 7000
Symphony Lotus Development	Y	Y	Y	Y	Y	Not here yet	IBM PC with 320K RAM	\$695	Softsel 01-844 2040
The Incredible Jack/Jack2 Business Solutions Inc	***	**	*	***	N	Powerful and easy to use; runs under UCSD-p	Apple II from Pete and Pam IBM PC from Pace Software	£130	(0706) 212321 (0274) 729306
T/Maker III T/Maker Corporation	**	***	*	*	N	Somewhat unknown quantity	IBM PC, etc.	\$275	T/Maker (California) (415) 326-6103
Vizastar/Vizawrite	—	Y	Y	Y	?	Links to Vizawrite; not seen it yet	Commodore 64	£100	Viza Software (0634) 813780

Prices do not include VAT

A friendly environment

Ian Stobie looks at the highest level of integration — the mouse-and-icon systems found on Visi On, the Apple Mac and Xerox's Star.

AS PERSONAL COMPUTERS get more powerful the real hold-up in developing fully integrated applications is the limited facilities of the typical PC operating system. In hardware terms today's 16-bit micros are comparable to the minicomputers of about five years ago. Yet though they have similar processing power, increasingly large amounts of memory and often better graphics, until recently most PC operating systems were still fairly rudimentary by minicomputer standards.

The level of integration achieved by software suites which run under standard personal computer operating systems like CP/M and MS-DOS is still fairly superficial. You can move data between different applications, but the process is not always very easy. What is more, some useful information is often lost; for instance, column headings in spreadsheet data, or formatting information in data taken from a word-processing document.

Easy transfer

Real integration requires easy, even automatic, movement of data between applications, and the full retention of the structure of the data. A further key requirement is a standardised user interface in all applications. The user should not have to learn a new set of commands and a new way of doing things in each application.

One way of meeting these requirements is to expand the role of the operating system. This is the approach adopted by systems like the Macintosh, Lisa, Grid Compass and Xerox Star where, typically, all aspects of the user interface are handled by the operating system.

So all-pervading does the operating system become that it disappears from the ordinary user's view as a separate entity. It is always hard at work and the user is always interacting with it, even when using an application program. The operating system becomes indistinguishable from the applications it is running. The notion of running a program disappears, to be replaced by ideas like opening a window on an electronic desk top.

For these reasons "integrated environment" is a far more accurate way of

describing the new software than "operating system". By contrast, the older microcomputer operating systems like CP/M force the user into awareness of the operating system as a separate thing. The operating-system commands necessary to control them form a separate and often difficult language which has little resemblance to the way the user interacts with the system once an application program is running.

In providing a very full user interface the new integrated environments do a lot of work which was previously done by programmers each time they wrote a new application. If the routines which do these things are made available to application programmers they can write frequent calls to the operating system into their code to carry out routine tasks. This approach makes it easier to write new applications which are command compatible with existing ones, and they can be produced relatively quickly. The operating-system routines also impose standard data formats and ways of manipulating data, which in turn makes data compatibility between applications easier to achieve.

The cost of acquiring the development tools necessary for producing well integrated programs varies between the different systems. It is less than £200 for the Macintosh, but several thousand pounds for Visi On, which requires a separate Unix-based development system.

MAC

The latest and cheapest example of a fully integrated system is the Apple Macintosh. It costs under £2,000 for a single-drive system and is just beginning to become available in volume on the U.K. market.

We previewed the Macintosh in the March issue of *Practical Computing* and have since had the opportunity of using it with two applications, Macwrite and Macpaint. The illustrations on page 125 of this issue were produced with Macpaint.

The Macintosh environment is established by two substantial pieces of software. A built-in 64K ROM holds the user-interface toolbox, which contains the

most-used routines and those of most interest to anyone thinking of writing their own programs. A 46K program called Finder performs most other operating-system functions, aided by a further 200K of system files which are brought in off disc as needed.

The Macintosh system uses two different data formats for moving data round internally; pure ASCII text and pictures. ASCII text is used where visual attributes do not matter, for instance in numeric data held in

Well, this time I am going to copy teddy bears in off the clipboard, were I hope I put them from MacPaint. Let's first off generate a bit of text so I can have a paragraph or two to play around with.

Bears:



Bears, or other pictures, can't be next to each other horizontally unless that is how you draw them in MacPaint.

Output from Macwrite, Mac's Apple-written word processor, incorporating graphic images from Macpaint.

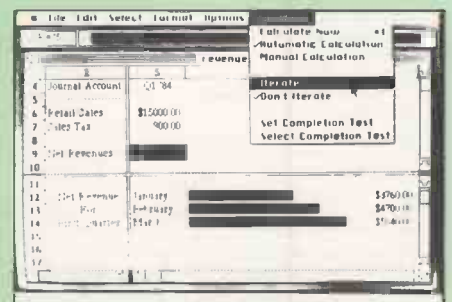

Microsoft's Mac Multiplan uses the Mac's system routines. Data can be transferred to other applications using the standard Mac Cut and Paste commands.

GRID

a spreadsheet. The picture format is established by a routine called Quickdraw in the 64K ROM; as well as drawing pictures it displays text when you use a fancy font. A routine called Scrap Manager, also contained in the ROM, is responsible for copying data between different applications. It can handle either ASCII text or Quickdraw-format picture data.

All this happens below the ordinary user's level of awareness. Its only manifestation is the easy and consistent way data can be moved around, both within and between applications. The usual way of doing this is to use the Cut, Copy and Paste commands.

Clipboard

First you select the information you want to copy by dragging the mouse pointer across it. You then pull down the Edit menu and select Cut or Copy, depending on whether you want to delete or retain the information in its original position. The system then transfers the selected text, drawing, table or whatever to the clipboard, an area of memory which if you choose to display it on the screen in fact looks like a clipboard.

To get information off the clipboard you first position the pointer where you want the information to go. This may simply mean scrolling through the document you are working on, or opening a new window for a new document or a different application, but in any case the clipboard will still contain the information you put on it. Having positioned the pointer, you click the mouse button to confirm the position, then pull down the Edit menu and select

Paste. The information is then transferred.

Frequently used text or pictures can be stored on another Mac entity, the scrapbook, from which it can be copied into documents and drawings as required. Microsoft, which is bringing out several applications for the Macintosh, uses the Cut, Copy and Paste commands in its Mac Multiplan. Because it looks very similar to existing Mac applications it is easy to learn to use. Data can be moved via the Mac's clipboard to other applications.

Mac software works generally in a very similar way to Apple's more up-market system, the Lisa. Both employ the desk-top metaphor, with multiple on-screen windows and icons. The differences are mainly in the hardware: the standard Mac comes with just one 400K disc drive and 128K of RAM, while the £5,500 Lisa comes complete with a 5Mbyte hard disc and 1Mbyte of RAM.

Visi On from Visicorp adopts a very similar approach to the Lisa and Macintosh. But it is a software-only product and is designed ultimately to run on a range of machines rather than being tied to a specific hardware configuration. Visi On does not go as far as replacing a machine's native operating system altogether; instead it supplements it with a whole range of runtime utilities and software tools which are used by Visi On applications. They sit on top of the operating system, which is generally MS-DOS.

In practice the effect is the same. The operating system disappears from view, and the user is faced with a single uniform integrated environment. Visi On requires a hard-disc system, and the IBM PC XT with the necessary software costs about the same as a comparable Lisa system.

The Grid Compass, reviewed on page 90 of this issue, can run either MS-DOS or software running under its own operating system. Grid OS costs £785 and comes complete with a set of applications which do the common tasks of word processing, spreadsheet analysis, business graphics, record keeping and communications. These applications are both command and data integrated.

The Grid OS user interface employs a mixture of menus and keyboard commands. The system is simple to use and is applied consistently. The keyboard commands involve holding down the Code key and hitting another key which determines the action to be implemented. Keyboard overlays and several context-dependent help screens are provided to remind you of the commands.

For instance, having typed data into a Gridplan spreadsheet, Code-T brings up the transfer menu, from which you can save and exit or transfer data across to another application. You can take a column across to Gridplot this way.

Once you are in Gridplot, Code-G causes a graph to be drawn with current options set; or Code-O lets you choose from a whole range of graph types and options. Gridplot is very fast at plotting to the screen as it uses the Grid's 8087 arithmetic co-processor for its calculations. Output can also go to the printer or a Hewlett-Packard plotter connected to the Grid's IEEE-488 interface.

(continued on next page)

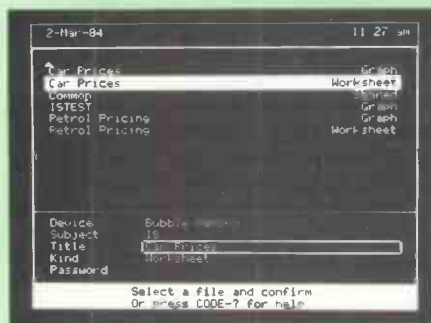

1. A Grid menu. You select an item by moving the bar over it, and fill in form items at the bottom of the screen.

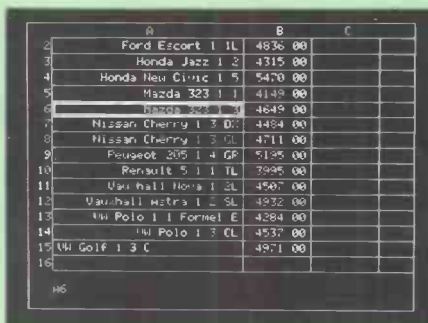

2. A Gridplan worksheet. Items can be transferred to Gridplot to produce graphs, or to Gridwrite to include in documents.

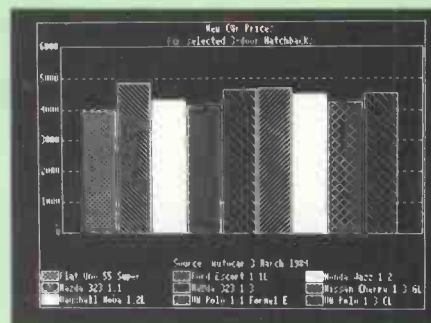

3. The same price data transferred to Gridplot; the smaller size 80-column type font has been used to label the graph.

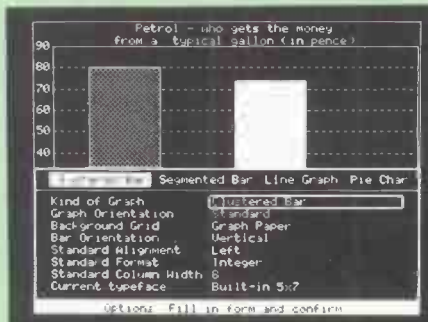
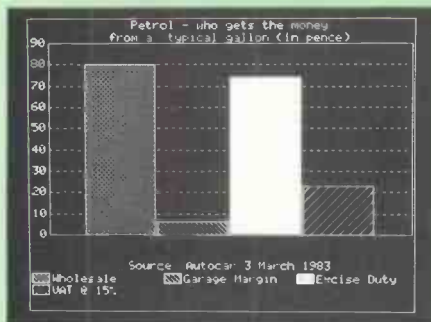

4,5,6. Two ways of showing one set of petrol price data. Gridplot encourages you to try out different ways of displaying data as there are lots of options and it is very fast. The middle picture shows the options menu.

(continued from previous page)

Gridplan or Gridplot images can be transferred across using Code-T to documents produced with the word processor, Gridwrite. You can move spreadsheet data and then manipulate it, or include exact screen images. Gridfile, the Compass's database program, is also data integrated with the other applications.

XEROX

Xerox pioneered software integration at the Palo Alto Research Center, but it has been other companies which seem to have learnt most from Parc's work. Larry Tesler moved from Xerox Parc to Apple and is credited with the principle design for the Lisa. John Ellenby spent six years at Parc before leaving to found Grid Systems Corporation.

Xerox itself has acquired the reputation of not getting products based on its own research to market, but the company does have an integrated product, the Xerox Star. The Star 8010 professional work station has been around since 1981, and it carries integration a stage further than the other systems discussed in this article. The catch is that it is expensive.

The Star can be used as a stand-alone unit, but it is intended as part of a network

which can have a variety of different Xerox systems attached to it. The network can be connected up via telecommunications lines to other networks anywhere in the world.

The basic Star 8010 unit costs £12,000 with the standard word-processing and system utility software package. The hardware includes a large 15in. by 12in. black on white screen, a two-button mouse and a keyboard. A system box the size of a small filing cabinet contains a custom-built Xerox 16-bit processor, a 1.2Mbyte 8in. floppy disc and a 10Mbyte hard disc.

The screen has a 1,024- by 809-dot resolution and a high refresh rate, ensuring that the display is very stable. Excellent display quality is central to the Star approach, where documents are displayed exactly as they will print out, spread out on an electronic desk top. The display is large enough to show a full A4 document at the same time as a large number of graphic symbols or icons, which represent other documents as well as tasks the system is ready to perform.

Over 500 Xerox 8000 local area network systems have been sold, according to Xerox, with prices starting from around £60,000. Stations are connected to the network by lengths of co-axial cable of up to 500 metres. As well as the Star work stations, cheaper Xerox systems, including the 860 and the Z-80 based 820 can be connected to the network.

Text generated anywhere on the network can be transferred across to a Star work station for editing and enhancement. An icon on the Star screen called Converter can be opened to carry out the necessary reformatting. The Star's own text-editing software can handle multiple typefaces and sizes, and there is an optional package which provides support for mathematical notations.

An 8000 network consists of a set of work stations plus a number of servers to carry out common functions. For example, a £15,000 laser print server can produce up to 12 pages a minute of very high-quality output, enabling documents to be printed in even higher resolution than they appear on the screen. The quality is, in fact, almost up to typeset standard.

Central support

Documents can be held locally on your own work station's discs or centrally. File servers are available with 29Mbyte to 300Mbyte disc capacities. Your own files held on the central file server are represented on the screen by a drawer icon with your name on. Documents in the drawer marked Common can be accessed by everyone on the network. Electronic mail is also supported by the file server, and is represented by In and Out mail tray icons. When a message arrives, a small envelope appears in your tray.

The communications server allows stations on the 8000 network to establish links with other networks using the Ethernet standard as well as remote terminals and mainframes. On the Star all these server features are integrated into the standard user interface. For example, to transfer a file to a Star on a remote net in Sweden involves first opening up the net support window and answering a few questions to establish the link. The system then creates a new icon for the work station you are concerned with in Sweden, which you could name Sweden, or Goran, or Nils or whatever. 

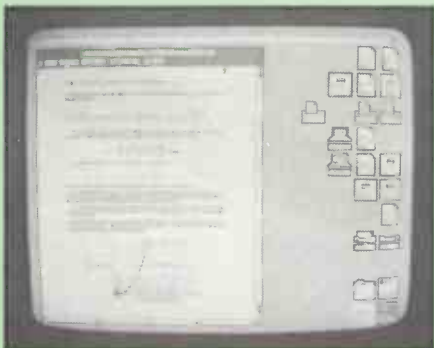

The screen can show an A4 page of text and graphics as well as a large number of icons.

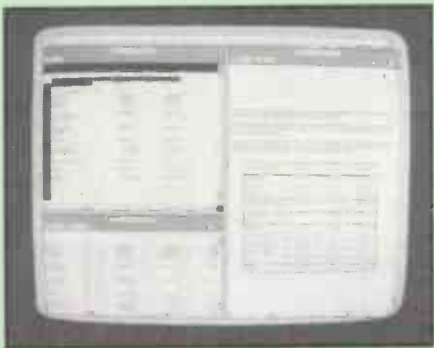

Spreadsheet data can be reformatted as a table and then copied across into a word-processing document.



A working office with a Xerox network. The two systems in the foreground are Xerox Star work stations.

Without the right program your computer could take a dim view of your accounts.

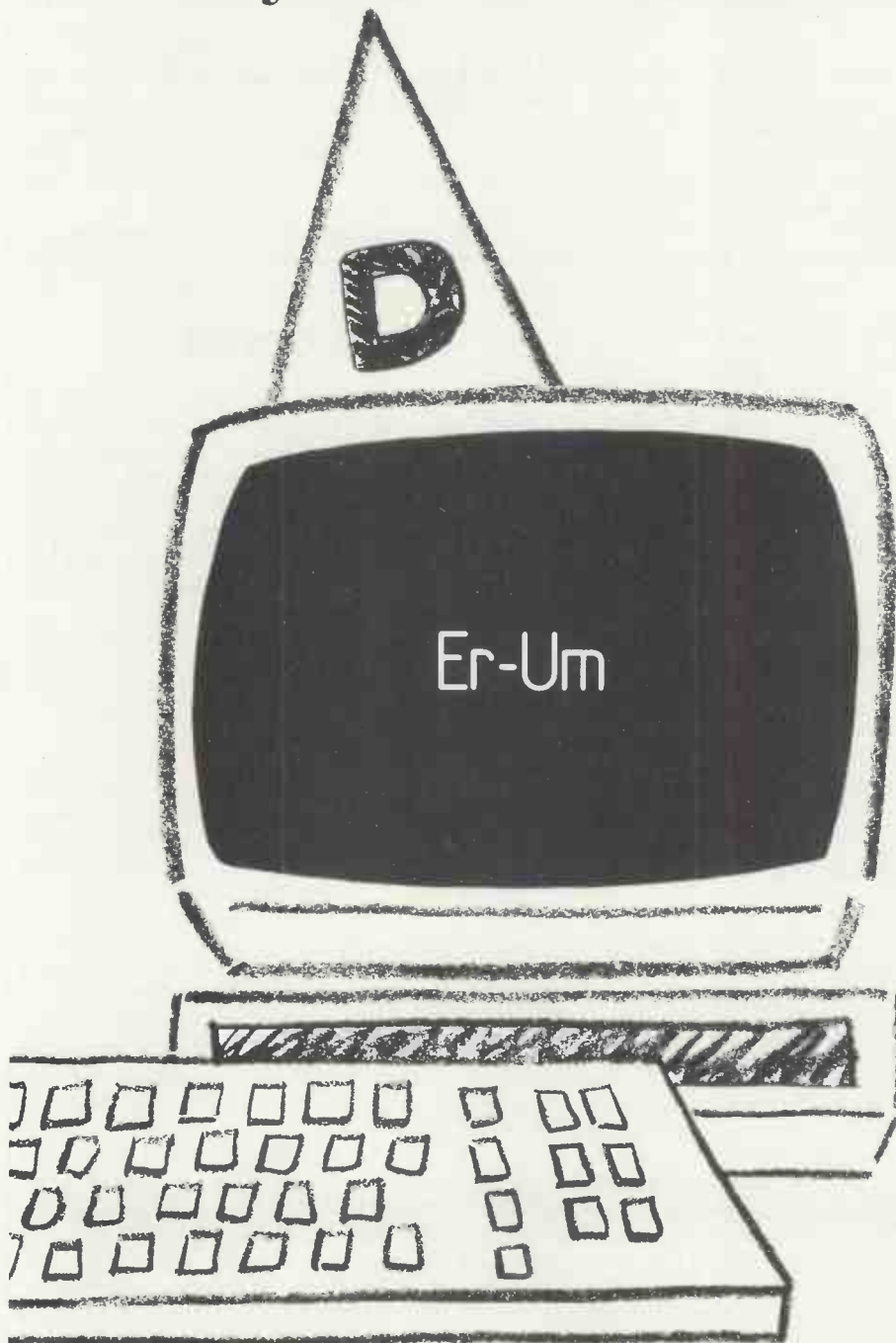

If your brand new, super-intelligent, electronic brain appears decidedly thick, it's probably not to blame. A computer is just a box of circuits. It's the program that makes it a box of tricks. Some programs are so inadequate they would make any computer look moronic. Others are far too complicated for the needs of the user and become uncontrollable monsters.

You'll be glad to know that Sage keeps things simple, but effective. Our fully-integrated, one-diskette programs are easy-to-learn and use, yet cover every accounting function. From invoicing to final accounts, it's all there!

Sage is available on most CP/M, MS-DOS and PC-DOS computers and has so far been implemented on over 40 machines including Apple, Apricot, Epson, IBM-PC, Philips, Sirius and Zenith. What's more you can choose the program to suit your needs from four great-value options.

● SAGE ACCOUNTS £375

● SAGE PLUS £525

● SAGE EXECUTIVE £695

● PAYROLL £195

Just return the coupon below and we'll make sure your computer doesn't end up standing in the corner.

- Please send me your explanatory brochure.
- Please arrange for me to have a demonstration.
- I do not yet own a computer.
I have a computer.
*Delete as appropriate.

Name

Position

Company

Address

.....

Tel:

.....

.....

.....

.....

.....

.....

.....

.....

.....

.....

.....

.....

.....

.....

.....

.....

.....

.....

SAGE

Business Software

SAGESOFT LTD., Hawick Crescent Industrial Estate, Newcastle upon Tyne NE6 1AS.

Tel: 0632 761669. Telex: 53623 SAGESL G.

PC1

● Circle No. 174

Balancing the books

Mike Lewis on how to avoid computer-aided disaster in the accounts department.

THE DEFINITION of an integrated accounting package is simple. It is one in which a single transaction updates all the relevant account balances at the same time. Put another way, it means that the very basic principles of double-entry book-keeping are always maintained.

The term "integration", as applied to accounting packages, is much abused. Scores of software products sport this adjective in the hope of boosting their prestige, but their claims often rest on shaky foundations. The mere use of compatible file formats or like-looking menus does not in itself make an integrated package.

Balance to nil

Yet these basic principles are not hard to grasp. Suppose you run a bicycle shop. You sell a new roadster to a certain Mr Polly, and you invoice him £100 plus £15 VAT. The next time you write up your accounts, you will debit Mr Polly's account in your sales ledger with the amount he owes, £115. You will credit the sales account in the nominal ledger with £100 and the VAT account with £15. When you eventually receive Mr P's cheque, you will credit his account with £115 and debit the cash account with this same figure.

Your shop's books of accounts form an integrated system. Each invoice, cheque or other transaction is fully reflected throughout the accounts as soon as it is entered. You could total all the accounts at any time and expect them to balance down to nil. In other words, the sum of the debits would equal the sum of the credits.

Of course, most businesses have more complex account structures than this as the diagram shows. In practice you would probably use secondary books, such as day books and a cash book, as a convenient way of batching the transactions. But as soon as they enter the main books the full double-entry is made.

So it is with an integrated computer system. The fact that a system is built on the three classic modules — sales, purchases and nominal — each of which can pass data to the others, does not mean that the package is integrated. It is the simultaneous updating of balances that is at the heart of the matter.

A transaction does not have to update the various accounts as soon as you enter it. The better systems will batch the transactions in a holding file, giving you a chance to sort out any typing errors. The actual posting only takes place when you are happy with the data. This not only improves accuracy, it also saves operator time because you do not have to wait for so many disc accesses while you are typing.

The main penalty involved in integrated accounting is the increased storage needed. You have to be able to have all the accounts in all the ledgers on-line at the same time. Most floppy-based systems will cope with this. But if you have around 200 customers and suppliers and only some 160K per floppy, you might have to forego integration.

On the other hand, even if your hardware can support integration, your volumes might not justify it. If you have several hundred account customers, it will almost certainly be worthwhile to computerise your sales ledger. But if you have no more than half a dozen regular suppliers, you will probably find it easier to do your purchase ledger by hand, or to dispense with it entirely. In these circumstances, partial computerisation is clearly more cost-effective than integration. The important thing is then to ensure that the computer and manual systems dovetail together.

Audit trail

So what points should you look for when choosing an integrated accounting package? A good audit trail must certainly be at the top of your checklist. It is vital that each transaction can be traced right back through the system to its point of entry. The system should allow transactions to be numbered in some way, and to be cross-referenced against their balancing entries.

Another essential requirement is for a control mechanism to spot the inevitable typing errors that we all make. The simplest method is based on batch totals. Here the operator manually calculates the total of the invoices, cheques and so on in a batch of transactions, and enters this figure into the system. If the total differs from the figure that the program itself calculates, the operator is obliged to trace and correct the

error before the batch can be accepted.

For the sales ledger you will have to make a choice between the two methods of preparing customer statements: open item or balance forward. In the latter, the account is notionally ruled off at the end of the month, with the closing balance brought forward. The customer's statement shows the opening balance, the month's transactions, and the closing balance. An open-item statement, on the other hand, shows all the unpaid invoices, going back as far as necessary.

Extra detail

Open-item accounts are likely to be appreciated by your customers, since they provide more detail. Their disadvantage lies in the greater effort needed to match individual payments and invoices. Whichever method you choose at the outset you are likely to be stuck with it, although a few packages permit you to specify the method individually for each customer.

A common reason for choosing the open-item method is that it allows balances to be aged. The statement can then analyse the balance according to the month in which the amount was due, which is invaluable for those responsible for chasing debts. Many systems print the same analysis in tabular form as an aged debtors list. Some go further by interfacing with a word-processing package to produce chase letters of increasing severity.

In the purchase ledger, the equivalent of the aged debtors list is the forward payment schedule. This analyses each creditor's balance by the month in which it is due. In practice, most firms can dispense with this because they do their payment runs on a strictly monthly cycle, with all invoices dated in January being paid in February, and so on.

A more important feature of the purchase ledger might be its ability to print cheques along with the remittance advices. For smaller companies this is not always as attractive as it might sound. If you draw fewer than, say, 20 cheques in the month, the time to load and unload the special stationery might be greater than that needed to write the cheques by hand. The special cheques are also more expensive than the traditional kind.

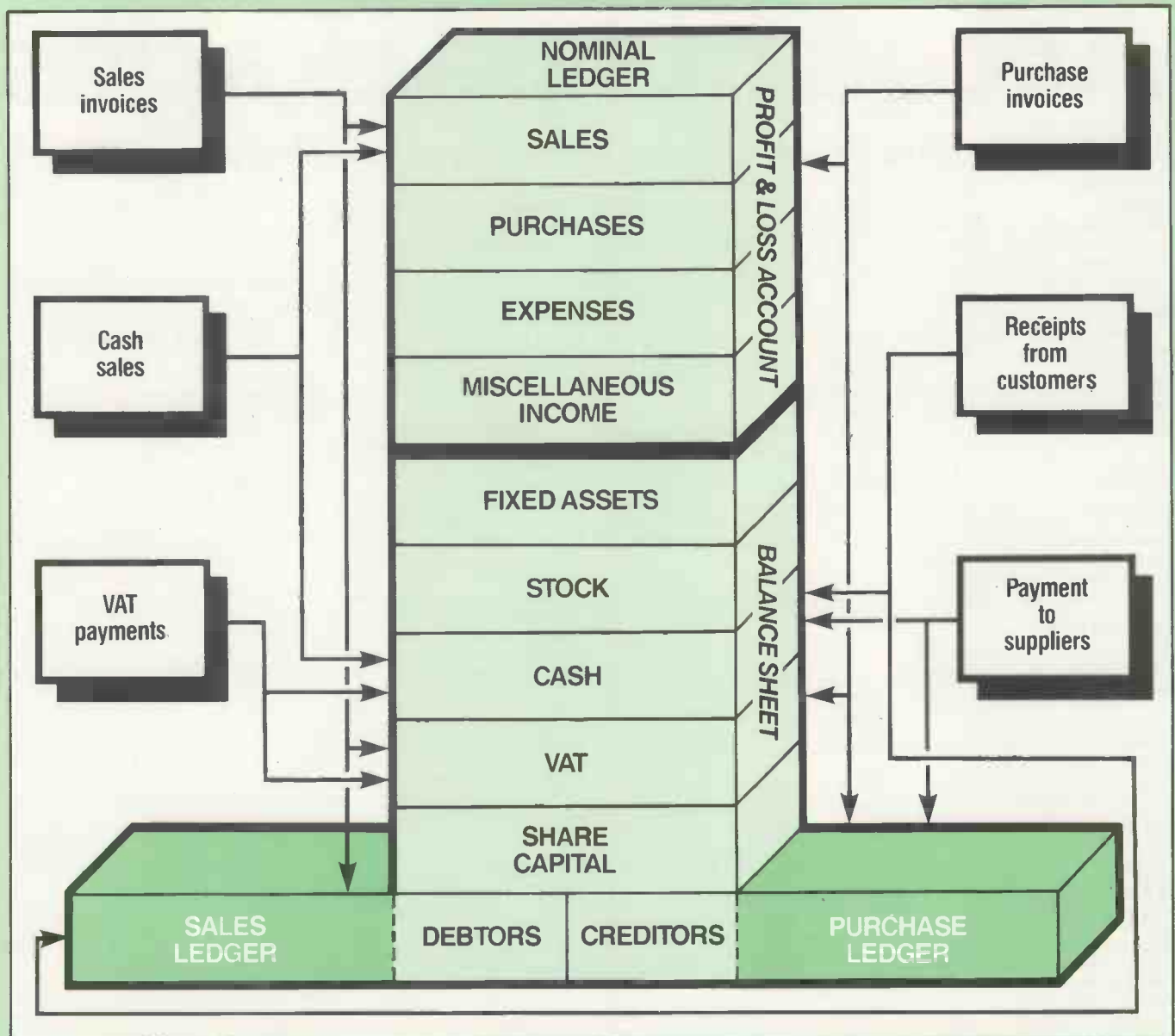

How the principal trading transactions affect the various account balances. The sales and purchase ledgers can be considered as subsets of the nominal ledger. The figures for debtors and creditors in the balance sheet are the totals from sales and purchases ledgers respectively.

The remaining component of the integrated package is the nominal ledger, from which the final accounts will ultimately be derived. As a minimum, this part of the system will provide two printouts. The first is a full listing of each account, showing all the transactions that have been posted. It is equivalent to the customers' statements in the sales ledger and the remittance advices in the purchase ledger.

The other output is the trial balance. At its simplest, the trial balance is no more than a list of all the nominal accounts with their balances. Most packages go at least one step further by analysing the balances according to whether they are profit and loss account items or those belonging in the balance sheet.

You can then look at the arithmetic total of all your P&L balances to get a rough idea of your overall net profit.

I say rough idea because your accountant will want to knock around the profit figure a bit before it can be considered final. The system must therefore have a mechanism for posting depreciation, bad debts, stock write-offs and the score of other adjustments that might be needed. In fact, it must be possible to transfer an amount from any account to any other in any of the ledgers, if only to reverse any erroneous entries that might have crept into the system by accident.

The end-product of the whole thing is the final profit and loss account and balance sheet. Surprisingly, many accounting packages stop short of these seemingly vital

printouts. This is not because of laziness on the part of the programmers, but a reflection of the huge variety of different formats that might be used for these two sheets of paper. Providing a mechanism for the user to specify sub-headings, sub-totals and account groupings can be the most complex part of the system.

An alternative approach which many suppliers now favour is to produce the final accounts in the form of a disc file that can be passed to a word-processing program. This takes a lot of the hard work out of the job, but still gives you sufficient flexibility to format the accounts the way you like them.

One last word of advice. Do not attempt to computerise your accounts without first seeking the views of your accountant. This is doubly true for limited companies. A system which does not provide all the information needed for an audit is worse than useless. The right integrated accounting package can save you considerable time and money, but never forget that most computer disaster stories start in the accounts department. 2

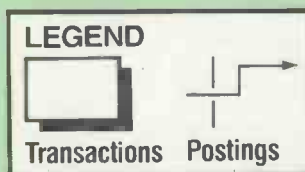

Accounts packages

A selection of the leading integrated accounting systems for popular micros.

ACCENSE CP/M

Modules available include sales, purchase and nominal ledgers, stock control, sales and purchase order processing
Price: £600 per module
Supplier: Selven Limited, 3-5 Guithavon Street, Witham, Essex CM8 1BJ. Tel: (0376) 519413

ACORNSOFT SMALL BUSINESS BBC Micro

Home-grown suite from Acorn requiring Model B with 40-track disc drive. Accounts payable, accounts receivable, purchasing, stock control and others available
Price: £24.95 each
Supplier: Acornsoft Ltd, 4a, Market Hill, Cambridge CB2 3NJ. Telephone: (0223) 316039

ACT PULSAR

ACT Sirius, Apricot, IBM PC
 Eight modules: sales, purchase and nominal ledgers, stock control, invoicing, payroll, data analysis, plus Informer database
Price: £195 per module except Informer, which is £295
Supplier: ACT Pulsar, Highfield Court, 24 Highfield Road, Edgbaston, Birmingham B15 3DT. Telephone: 021-455 7000

AXIS

CP/M, CP/M-86, MP/M, Concurrent CP/M
 Written in assembler, this integrated series offers sales, purchase, nominal ledgers, stock control, costing and mailing facilities
Price: £200 to £500
Supplier: Soft-pac, 14 Castle Street, Bridgewater, Somerset TA6 3DB. Telephone: (0278) 421020

CFACC

CP/M, CP/M-86, MS-DOS
 All standard modules accessed from main menu. Specialist versions available
Price: £1,650 for complete system; £1,250 for small business version
Supplier: Logical Step Ltd, Wellesbourne House, Walton Road, Wellesbourne, Warwickshire CV35 9RH. Telephone: (0789) 8842082

EASY

IBM PC, Apricot, Torch, ICL, Seiko, MS-DOS
 Three systems available — Easy Junior, Easy and Easy Plus — with data upgrade paths between them
Price: Junior £295 for complete system; Easy £300 per package, multi-user; Easy Plus £300 to £500 per package
Supplier: Scorpion Computing Ltd, Scorpion House, Hartley Witney, Hampshire RG27 8NS. Telephone: (025 126) 3706

IBIS

ACT Sirius, Apricot, IBM PC, Wang PC
 Six modules: sales, purchase and

nominal ledgers, stock control, stock/order processing, and payroll
Price: Most modules £350 each; payroll £600; incomplete records £995
Supplier: Ibis Business Information Systems Ltd, 47 Watergate Row, Chester CH1 2LE. Telephone: (0244) 317527

INTEGRATED ACCOUNTING BBC Micro

Single disc offers purchase, sales and nominal ledgers, VAT analysis and management information
Price: £125
Supplier: Diamondsoft Ltd, Bridge Buildings, 11a Ladybridge Road, Cheadle Hulme, Cheshire SK8 5LL. Telephone: 061-485 8705

LSBS-F

Concurrent CP/M, CP/M, MS-DOS
 Seven packages including sales, purchase and general ledgers, names and addresses, stock control
Price: £220
Supplier: Graftcom Systems Ltd, Rickett Street, London SW6. Telephone: 01-385 9422

OFFICEMATE

IBM, Sirius, Commodore
 Modules offered include cash book, sales book, purchase ledger, nominal ledger and payroll. All modules can be linked
Price: from £25 to £255
Supplier: Micro Computer Centre, 28 Sheen Lane, London SW14. Telephone: 01-878 7044

MICROFACTS

ACT Sirius and Apricot, DEC Rainbow, IBM PC, Commodore 8000 series
 Microfacts Mark II runs on Commodore systems and covers sales, purchase and nominal ledgers, sales/invoicing, job costing and stock control. Mark V system for 16-bit machines adds payroll and nominal ledger reports
Price: £300 per module, except nominal reporting £150
Supplier: Facts Software Ltd, Ketwell House, 75-79 Tavistock Street, Bedford MK40 2RR. Telephone: (0234) 218191

MICRO-SIMPLEX

Commodore 8000, Commodore 64, Sharp MZ-80, BBC Micro
 Based on Simplex D cashbook. Covers cash, sales and purchases, and VAT in a simple way. Can be linked to Chubb cash registers. Add-on ledger system — sales, purchase and nominal — available for Commodore 8000 systems
Price: £995 for Commodore 8000, £150 for Commodore 64, £250 for BBC and Sharp systems. Ledgers cost £395
Supplier: Micro-Simplex, 8 Charlotte Street West, Macclesfield, Cheshire SK11 6EF. Telephone: (0625) 615000

PAXTON BUSINESS DESK

CP/M-80, CP/M-86, MS-DOS, IBM PC, Mmmost, Turbodos
 Business Desk AC does sales, purchase and nominal ledgers; PF adds invoicing from price file; SF adds stock control; SOP adds sales order processing. All can be made multi-user with addition of multi-user resource manager
Price: AC £595; PF £795; SF £1,200; SOP £1,600; Multi-user RM £350
Supplier: Paxton Computers Ltd, 28 New Street, St. Neots, Cambridgeshire PE19 1AJ. Telephone: (0480) 217777

PEACHTREE ACCOUNTING

CP/M-80, CP/M-86, MS-DOS, IBM PC, Apple II and III
 Peachtree does three different accounting suites. The standard version is written in Basic with five modules including payroll. Cobol system can be multi-user and adds costing and sales order processing modules. Pascal p-System suite runs on IBM, DEC and Sirius, with similar version for Apple II and III
Price: Basic £350 per module; Cobol £600 per module; p-System £190 per module
Supplier: Peachtree Software International Ltd, 99 King Street, Maidenhead, Berkshire SL6 1YF. Telephone: (0628) 32711

PEGASUS

MS-DOS, IBM PC, Rainbow 100, Commodore 8000
 Seven modules: sales, purchase and nominal ledgers, sales order/invoicing, stock control, payroll, job costing
Price: from about £300 to £500 per module, depending on level of dealer support
Supplier: Pegasus Software Ltd, Brikat House, 35-41 Montagu Street, Kettering, Northamptonshire NN16 8XG. Telephone: (0536) 522822

POWERSYSTEMS

CP/M
 Range of modules including sales, bought ledgers, foreign currency ledgers. There is a 15 percent annual service charge
Price: £600 to £850 per module; £1,500 for foreign-currency ledgers
Supplier: Omicron Management Software Ltd, 26-28 Great Portland Street, London W1N 5AD. Telephone: 01-636 6575

SAGE, SAGE PLUS

CP/M-80, MS-DOS, IBM PC
 Standard Sage system combines sales, purchase, cashbook and general ledger. Sage Plus adds credit control, VAT and budget variance reports and other features
Price: standard Sage £375; Sage Plus £525
Supplier: Sagesoft Ltd, 1 Hawick Crescent, Newcastle upon Tyne NE6 1AS. Telephone: (0632) 761669

SKYMASTER

IBM PC XT or IBM PC plus hard disc, IBM LANs
 Works with multi-user IBM PC networks including PC Net, Plan 2000 and Omnet. Seven modules: sales order/invoicing, sales, purchase and nominal ledgers, stock control, payroll and contract costing
Price: £500 per module
Supplier: Sky Software, 13 New Road, Bromsgrove, Worcestershire B60 2JG. Telephone: (0527) 36299

SUNACCOUNT

CP/M, MS-DOS, Unix
 A single package offers sales, purchase and nominal ledgers. It is possible to link Sunaccount with Supercalc, Multiplan and dBase II. Data may also be transferred to WordStar documents
Price: Single user £1,250; multi-user £1,750
Supplier: Systems Union Ltd, 34 Delancey Street, London NW1 7NH. Telephone: 01-485 2594

SYSTEM II

Tandy Model III and Model 4
 Nominal, purchase, sales ledgers and stock control available
Price: £299 per unit
Supplier: Molimerx Ltd, 1 Buckhurst Road, Town Hall Square, Bexhill-on-Sea, East Sussex. Telephone: (0424) 220391

SYSTEMATICS ACCOUNTING IBM PC, Sirius, Apricot, Apple IIe and III, Sage

Written in UCSD Pascal, running under p-System. Modules available include general, sales and purchase ledgers, job costing, payroll and word processing
Price: £175 to £375 per unit
Supplier: Systematics International, Cleves House, 14 Hamlet Road, Haverhill, Suffolk CB9 8EE. Telephone: (0440) 61121

TABS

MS-DOS, CP/M, Apple
 Easy Tabs packages include standard ledgers and word processing, mailing list. Integrated Tabs offers more packages with more sophisticated facilities. Super Tabs for accountants and will include tax modules
Price: Easy Tabs £100 each; Integrated Tabs £50 to £500
Supplier: Tabs Ltd, Dolphin House, New Street, Salisbury, Wiltshire SP1 2PH. Tel: (0722) 338668

UNIQUE CP/M, CP/M-86, MS-DOS

The Unique business accounting and management system offers a general accounting module
Price: £280 to £750
Supplier: Unique Computer Applications Ltd, The Grove, Pimper's Lane, Harpenden, Hertfordshire AL1 7AJ. Telephone: (05827) 60107

EVERYMAN™

The Database

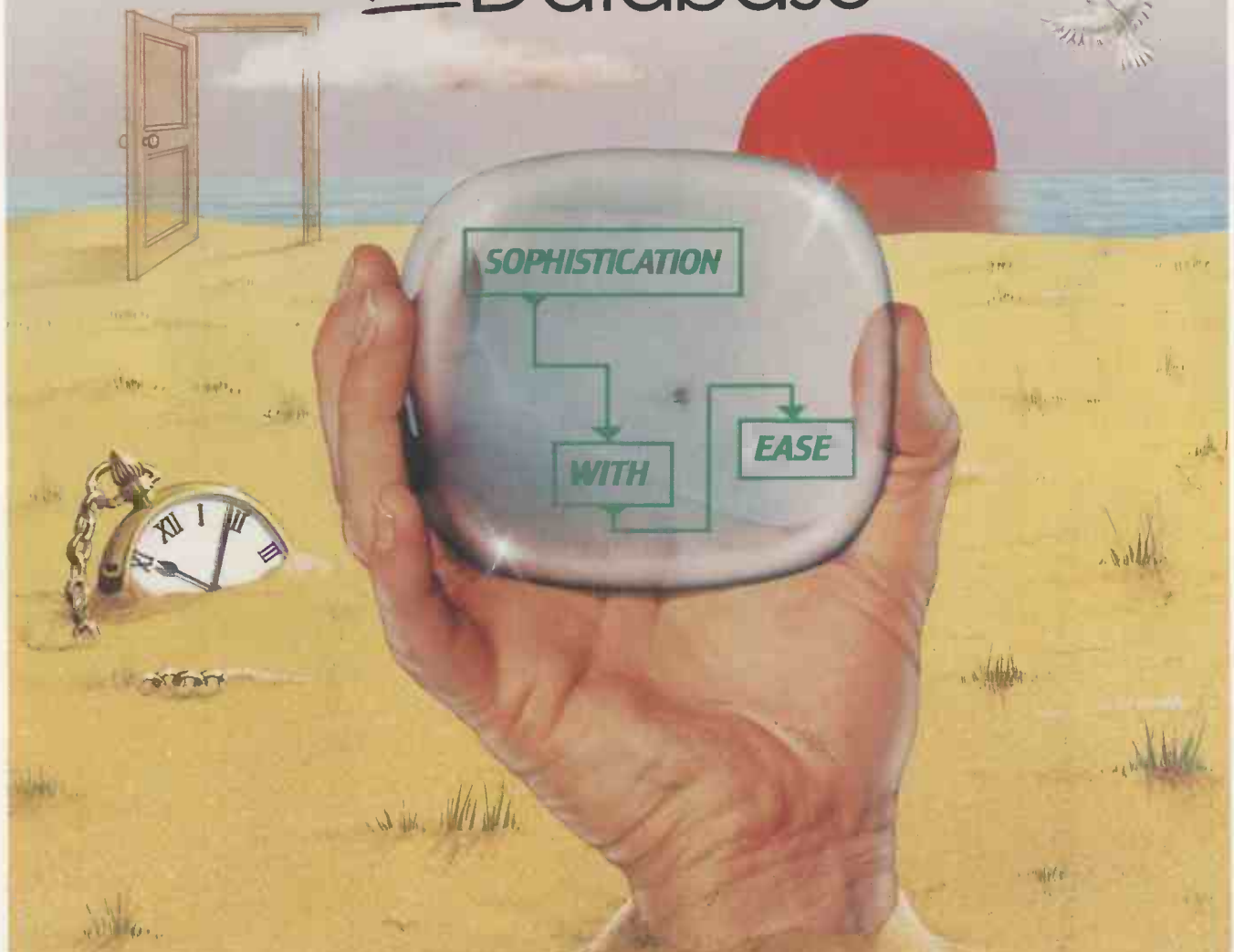

Your business at the touch of a key.

EVERYMAN is the information system designed to turn your 16 bit micro into a business tool more powerful and more flexible than you dreamed possible.

Using a revolutionary new visual concept that requires no programming and offers no language barrier, EVERYMAN allows you to paint solutions to problems, however complex, directly on the screen. It's so easy to understand you'll be an expert from day one – an expert with easy access to multiple files and (thanks to EVERYMAN'S window functions) able to cross reference and view your data any way you like. Within minutes you can model solutions to your own 'real world'

problems – solutions that can be recalled at the touch of a key at any time, while EVERYMAN maintains the logic and database integrity for you.

EVERYMAN is supported by full documentation including a tutorial that allows you to run like an expert in around 3 hours (with a little aid from EVERYMAN'S help screens if you need it). The whole package is backed by a comprehensive 12 month guarantee that includes upgrades to all registered users.

Talk to your dealer today about EVERYMAN – it'll put you generations ahead!

EVERYMAN™

vector
international

...THE RIGHT DIRECTION

Vector House, 6a Lower Teddington Road, Hampton Wick, Kingston-upon-Thames, Surrey KT1 4ER. Tel: 01-943 1257/8/9/0.

● Circle No. 175



1 PULSAR SOFTWARE CENTRE

Don't be fooled into thinking that microcomputer business software is an easy buy. You could spend weeks or months just looking and looking . . . and then you still have to make that software work for your business.

If you really want to find the most cost-effective software solution talk to a Pulsar Software Centre.

Hand-picked by ACT for their expertise in understanding business problems, and successfully implementing microcomputer systems, each Pulsar Software Centre has a proven track record; from business analysis and hardware and software selection to implementation support and training. For a demonstration of professionalism in action, contact your nearest Pulsar Software Centre now.

Integrated Accounting
Spreadsheets
Stock Control

Networking Systems
Word Processing
Databases

Financial Modelling
Payroll
Languages and utilities

Saracen Data Products



dyJan **Dysan**
CORPORATION

FLEXIBLE DISKETTES

Prices per Box (£)

	1-4	5-9	10-49	50-99
104/1 Single Sided, Single Density	21.30	19.20	18.30	17.39
104/1D Single Sided, Double Density	23.43	21.20	20.13	19.12
104/2D Double Sided, Double Density	35.20	31.46	29.92	28.42
204/1D Single Sided, Quad Density	35.20	31.46	29.92	28.42
204/2D Double Sided, Quad Density	44.22	39.60	37.62	35.74
3740/1 Single Sided, Single Density	33.11	29.59	28.16	26.75
3740/1D Single Sided, Double Density	34.21	30.58	29.10	27.59
3740/2D Double Sided, Double Density	40.51	36.41	34.54	32.81

SONY

3½" OMD 3220
AVAILABLE FROM
STOCK
£45.00 PER BOX OF 10

Dysan UHR II Media CONTACT US FOR PRICES & DELIVERY

DYSAN RIGID DISK PACKS

THE FULL RANGE OF DYSAN DISK PACKS IS AVAILABLE CONTACT US FOR PRICES.

MEDIAGUARD — Fire Safe
£279.00 Each —
FREE BOX OF 8", 5½" OR 3½"
DISKETTES WITH EVERY
MEDIAGUARD.

THIS OFFER ONLY AVAILABLE
TO RETAIL CUSTOMERS

- LARGE VOLUME DISCOUNT PRICES
- TRADE PRICES AVAILABLE ON REQUEST
- FREE DELIVERY ON ORDERS OVER £100.

ALL PRICES SUBJECT TO V.A.T.

RING US NOW FOR
YOUR COPY OF OUR ILLUSTRATED PRICELIST

Saracen Data Products Limited

176-180 High Street, Dorking, Surrey, RH4 1QR Tel: (0306) 887550 1888271

● Circle No. 176

● Circle No. 177 ▼

Birmingham	Micro Dynamics	021 455 7971	London W1	Spiro Enterprises	01 499 1608
Birmingham	*The Byte Shop	021 622 3165	London NW1	*The Byte Shop	01 387 0505
Blackburn	Dextrafile	0254 691 235/6	Maidstone	*Advanced Computer Services Ltd	0622 58289
Blackpool	Western Computers Ltd	0253 404676	Manchester	*The Byte Shop	061 236 4737
Brighton	Micro Nationwide (Brighton)	0273 672505	Newcastle	*Thos Hill International	0632 739 261
Bristol	*Concorde Micro	0272 279720	Northampton	Danetre Business Systems	0604 36231
Cheltenham	Petri Systems	0242 42466	Nottingham	*The Byte Shop	0602 470576
		0242 45220	Nottingham	*The Data Base	0602 413244
Chepstow	P-CAM Systems	02912 70241	Plymouth	Diskwise	0752 267 000
Edinburgh	*ACT Computer World	031 337 9870	Reading	*ACT Computer World	0734 508787
Edinburgh	*Robox Microcomputers Ltd	031 225 3871	Rugby	Greengage Computers Ltd	0788 705 63
Glasgow	*MBS Rentals	041 248 5665	Salisbury	Orbit Ltd	0722 337600
Glasgow	*Robox Microcomputers Ltd	041 221 8414	Shrewsbury	ACT Computer World	0743 68167
Glasgow	*The Byte Shop	041 221 8202	Slough	*MBS Soft	02812 3865
Keighley	KM Computing (Yorks) Ltd	0535 609 385	Southampton	*The Byte Shop	0703 334711
Kilmarnock	Trad Micro Systems	0563 43072	Swindon	*B & D Computing	0793 762449
Leeds	New World Microsystems Ltd	0532 582018	Thornaby	Hunting Business Systems	0642 760021
Leeds	VHA Computer Services	0532 732 442	Truro	Diskwise	0872 40045
Liverpool	ACT Computer World (Liverpool)	051 236 1112	Uxbridge	*Wilson Hughes & Partners	0895 53332
London EC4	*MBS Rentals	01 626 2181	Warrington	*Applied Micros	0925 819939
London E2	Concept Computers Ltd	01 739 0788	West Bromwich	Junction One	021 525 8851
London WC2	*Microplan (Strand) Ltd	01 930 0417	Worcester	Micro Dynamics	0905 611 808
London SW1	*Planning Consultancy Ltd	01 839 8890	Yateley	The Accounting House	0252 877 584
London WC1	*Spartex Micro	01 833 1867			

*Stockists of Pulsar Blue for the IBM — PC

Explore the Personal at the NEC

May 4-7

Open 10 am-6 pm daily.
10 am-5 pm Monday.



**THE Midland
Computer
Fair** *Personal computers
Home computing
Small business systems*

£1 OFF

This voucher entitles the bearer to a £1 reduction on the purchase of 1 adult or child full price ticket at the door. This cannot be used with any other offer.

May 4-7, 1984. National Exhibition Centre, Birmingham.
Open 10 am-6 pm daily.
10 am-5 pm Monday.

Midland Computer Age Birmingham



To see the very latest in microcomputers, peripherals, accessories and software visit the Midland Computer Fair.

Whether you already own a microcomputer, or are about to buy one, the show will be the best place to try the products with expert advice close at hand.

For business users the Midland Computer Fair really is a must with hardware, software and ancillary products all on show.

Entry to the show is FREE to bona fide businessmen upon production of a business card. Normal admission price is £2.50.

For further information contact: The Exhibition Manager, The Midland Computer Fair, Reed Exhibitions, Surrey House, 1 Throwley Way, Sutton, Surrey SM1 4QQ.

THE Midland Computer Fair

Sponsored by

Practical
Computing

YOUR
COMPUTER

LVL COMPUTERTOWN

Whether its your first computer or whether you're already an enthusiast, LVL COMPUTERTOWN offers you the quality of service you expect from experts. If you invest money, you go to a bank or a broker - a specialist who can guide and advise you on the best return for your capital. At LVL COMPUTERTOWN we're specialists too. We're there to help guide you through the micro maze, keep you up to date on innovations, help you get the best value for money, whether your computer is for you, your children or your business. Your computer can change your life - make sure you change it for the better: Come and talk to the experts and move into micros with LVL COMPUTERTOWN

COMPUTERS



£199.00



The new personal computer from Acorn Computers. An ideal machine for learning computing - and for having a lot of fun at the same time. But it's much more than just a toy. It's graphic facilities are the most sophisticated available in it's price range.



BBC MICROCOMPUTER

MODEL A	£299	MODEL B with DOS	£469
MODEL B	£399	Model B with DOS & ECONET	
MODEL B with ECONET	£446	£516

MONITORS



DECCACOLOUR

14" Colour Monitor

£247.25



SABA

14" Colour Monitor/Colour T

£274.45



MICROVITEC

14" Colour Monitor

£247.25



SANYO

12" Green Screen

£102.35

PRINTERS



Seikosha GP100A	238.05
Silver Reed EX500	
Parallel	343.85
Silver Reed EX500	
Serial	378.35
Silver Reed EX550	
Parallel	534.75
Silver Reed EX550	
Serial	569.25
Epson RX80	320.85
Epson FX80	503.70
Epson RX80 (F/T)	366.85
Epson MX100 (B2 Col)	546.25
Epson FX100	654.35



DATA RECORDERS



A REFLECTION OF SUPERIORITY

The Bell & Howell/LVL Computer Compatible Data Recorder

- Automatic Level Control
- Automatic Tape Stop
- Tape Counter
- Remote Motor Control

£39.95

DISK DRIVES

An example of superior technology, total reliability and outstanding performance, combine to produce the LVL Disk Drive Family.

Truly professional units designed to work with the BBC Microcomputer.



CHECK OUT
NEW LOW
PRICES WITH
YOUR NEAREST
DEALER.

SOFTWARE

DESIGNED FOR THE BBC MICROCOMPUTER

ACORNS&FT GAMES

Hopper

for the BBC Microcomputer Model B

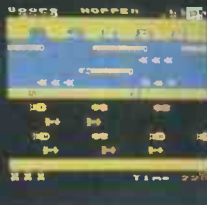

ADVENTURES	
Philosophers Quest	£9.95
Castle of Riddles	£9.95
Countdown to Doom	£9.95
Sphinx Adventure	£9.95

GENERAL	
Desk Diary	£9.95
Creative Graphics	£9.95
Graphs & Charts	£9.95
Tool Box	£21.00
Record Keeper	£13.80
Magic Garden	£9.95

EDUCATIONAL	
Map References	£7.50
Lasermaths	£7.50
Classmaster	£20.00
Algebraic Manipulation	£9.95
Word Sequencing	£11.90
Missing Signs	£11.90
Number Balance	£11.90
Word Hunt	£11.90
Density Circuit	£11.90
Chemical Analysis	£13.80
Chemical Structures	£13.80
Jars	£11.90
Vu-Type	£16.10

LANGUAGES	
LISP	£16.85
FORTH	£16.85
GAMES	
Monsters	£9.95
Snapper	£9.95
Planetoid	£9.95
Arcade Action	£11.90
Rocket Raid	£9.95
Meteors	£9.95
Arcadians	£9.95
Sliding-Block Puzzle	£9.95
Cube Master	£9.95
Starship Command	£9.95
Snooker	£9.95
Super Invaders	£9.95
Hopper	£9.95
Colditz	£9.95
Doctor Who	£10.00
White Knight II	£12.00
Missile Base	£9.95
Draughts & Reversi	£9.95

ALL PRICES
INCLUDE
VAT.
IAS

The items featured represent a very small selection from our vast product range, and at the time of going to press where all available from stock.

However, not all dealers carry every advertised item, please telephone before making your journey.

Further information of both product and services available can also be obtained by telephoning or visiting your nearest LVL Computertown Dealer.

CHESHIRE

C-TECH SOFTWARE
184, Market St
HYDE
Cheshire
061 366 8223

• COMPUTER CITY
78, Victoria Rd
WIDNES
Cheshire
051 420 3333

CUMBRIA

• THE COMPUTER SHOP
56/58 Lowther St.
CARLISLE
Cumbria
0228 27710

ESSEX

A.C.L.
1, Northmall
GRAYS, ESSEX
0375 79834
BROADWAY MUSIC
AND VISION
Woodford Green
ESSEX
01 504 7500

GREATER MANCHESTER

• LOMAX
8, Exchange St.
St. Annes Square
MANCHESTER
061 832 6167

WORCS

SPURTREE COMPUTING LTD
Council Buildings,
Teme Street,
TENBURY WELLS,
Worcestershire
0584 811353/811304

MERSEYSIDE

• THORNGUARD
46, Pensby Rd.
HESWALL
The Wirral,
Merseyside
051 342 7516

NOTTS'

S P ELECTRONICS
48, Lanby Rd.
HUCKNALL
Notts.
0602 640377

COMPUTERTOWN (UK) LTD.
230, Derby Rd.
STAPLEFORD
Notts.
0602 388484

OXFORD

ABSOLUTE SOUND
AND VIDEO (Oxford) Ltd
19, Old High St. Headington
OXFORD
0865 65861

AVON

K & K COMPUTERS
32, Alfred Street,
WESTON
SUPERMARE
Avon
0934 419324

COLSTON COMPUTER
CENTRE LTD.
The Colston Centre,
11, Colston Ave.
BRISTOL
0272 276619

YORKSHIRE

HOME & BUSINESS COMPUTERS
59, Daisy Hill
DEWBURY
Yorks
0924 459300

WEST MIDLANDS

JBC MICRO SERVICES
200 Earlsdon Ave.
Nth. Earlsdon
COVENTRY
0203 73813

WILTSHIRE

WILTSHIRE MICRO
CENTRE
Unit 6,
Central Trading Estate,
Signal Way,
Old Town,
SWINDON
0793 612299

BUCKS'

HI-VU ELECTRONICS
38, Church St. Wolverton
MILTON KEYNES
Bedford
0908 312808

SUSSEX

C.J.E. MICROS
78, Brighton Rd
WORTHING
West Sussex
0903 213900

ISLE OF WIGHT

EXCELL
4, Foreland Rd.
BEMBRIDGE
Isle of Wight
098 387 2578

YOUR LOCAL



DEALER

HEREFORD

KEMPSONS
26, St. Owen St.,
HEREFORD
0432 273480

KENT

KENT MICRO
57, Union St
MAIDSTONE
Kent
0622 52784

GRAVENSEND
COMPUTERS
39, The Terrace,
GRAVENSEND
0474 50677

LEICESTER

PERCY LORD & SON
63 Blaby Rd
WIGSTON
Leicester
0533 785033

LONDON

CANNONBURY RADIO
185 Upper St
ISLINGTON N1
London
01 226 9392

PAUL ELECTRICAL
250/2, Grand Drve.
Raynes Park.
LONDON SW20
01 542 6546

WOODS RADIO
257, Lavender Hill
Battersea,
LONDON
01 228 1768

SALOP

MEDLICOTT BROS
53, Mardol
SHREWSBURY
Shropshire
0743 3060

SUFFOLK

SJ EMERY & CO
10, Market Place
BUNGAY,
Suffolk
0986 2141

IRELAND

EVERYMAN COMPUTER
SERVICES
BALLYMONEY
Co-Antrim
N Ireland
026 56 62658

STAFFS

I W BAGNALL
18, Salter St
STAFFORD
0785 3420

KIRKLANDS
City Rd., Fenton
STOKE ON TRENT
0782 415787

• COMPUTERAMA
59 Foregate St
STAFFORD
0785 41899

SURREY

• HASLEMERE COMPS
25, Junction Place,
HASLEMERE
Surrey
0428 53850
P & H ELECTRONICS
5, The Parade,
Reading Road,
YATELEY
Surrey
0252 877 222

LANCASHIRE

• P V MICROS
38A Water St
ACCRRINGTON
Lancs
0254 36521

• Home & Business
Computers Ltd.
54, Yorkshire Street,
OLDHAM
061 633 1608

• Home & Business
Computers (RCH) Ltd.
73, Yorkshire Street,
ROCHDALE
0706 344654

WALES

S.I.R.
91, Whitchurch Rd
Cyncoed
CARDIFF
Wales
0222 621813

THE COMPUTER SHOP
41, The Hayes,
CARDIFF,
Wales,
0222 26666

SCOTLAND

COMMSCOT
30 Gordon St.
GLASGOW
041 226 4878

NORTH 'LAND

NEWTONS
Main St,
SEAHOUSES
0665 720307

AMAZING PROGRESS has been made in the six months since we last looked at Spectrum games. In November 1983 we found one outstanding new game, Manic Miner, and a lot of programs with pretty graphics that were pretty boring to play. Since then, not only have the graphics improved even further, but a lot of the games are now genuinely good to play. What's more, many of them are original, even if they are based on popular game ideas.

For example, there are a lot of copies of Donkey Kong, but none of the Spectrum ones come close to the Atari version or to Killer Gorilla on the BBC. However, the fundamental idea of climbing or platform games is used in two outstanding new programs from Quicksilver called The Snowman and Fred.

The Snowman

In The Snowman the ladders are paths in a garden, though they still function like ladders. The aim of the game is to complete The Snowman, which is modelled on Raymond Briggs' cartoon character, without losing all your lives. When you fall you are not killed. In fact, a bed appears at the bottom of the screen, and you topple gracefully on to it and fall fast asleep.

The Snowman is also a Pacman-type game. The ladders/platforms are part of a maze around which various dangerous things shuttle. In the first screen these are bundles of flames, which do not harm you but do melt any snow you are carrying. On the higher screens there are ghosts that send you straight to bed.

The graphics are beautifully drawn with lots of detail, and the screen image is unusually sharp and stable for a Spectrum game. All the movement is very smooth, and the use of sound is also very nice with toots of *Rudolf the Red-nosed Reindeer*. All these combine with the imaginative game ideas to make an extremely good game.

Fred

Fred is a ladders game combined with a maze game. Fred is an Egyptologist trying to escape from a maze similar to catacombs or the inside of a pyramid. The maze is filled with hazards, including ghosts — white-robed monks who float through walls — mummies, chameleons, acid drops, vampires, skeletons and lots of little rats that look more like red furry slippers.

You can shoot some of your enemies with a pistol. The rats you have to jump over in the way that Mario in Donkey Kong leaps over barrels. Movement is slow and jerky, and entirely suited to climbing up and down robes, which is what Fred spends most of his time doing.

Spectrum progress

Jack Schofield toys with the latest cassettes and finds attractive graphics coupled with original games.



Imaginative ideas and beautifully drawn graphics feature in The Snowman.



In Atic Atac you work out the rules for yourself — but it's worth the effort.



The Chequered Flag cockpit view . . .



Speed Dual's Graphics are not as good.



Outrun the ants in Ant Attack.



Scuba Dive — an excellent game.



With its exceptional graphics, Caesar the Cat is highly recommended for joystick use.

At the end of the game you get points for all the treasures you have managed to collect by walking over them, with bonuses for escaping from one or more of the six separate mazes. Finally you enter your initials in the Hall of Fame. Lest you get too big-headed about your talents, the High Score table comprises four wreath-strewn graves and your initials appear on one of the headstones.

Atic Atac

Probably the best game this month is Atic Atac, from Ultimate Play The Game. It is a combination arcade/adventure game but without text, like the sort pioneered by Epyx in 1981 with Rescue from Rigel.

Atic Atac's virtues include stable graphics, very smooth player movement, high-speed action and what looks like page flipping. That is, when you zip from one room to another, the display switches smoothly without appearing to be redrawn. All in all, it is hard to believe this game runs on a Spectrum.

One of Atic Atac's charms is that although it is an original game, the instructions don't tell you how to play. But I will not spoil it for anyone who hasn't got it. Suffice to say that it is worth the challenge. The fact that I have not got out yet I put down to struggling with the keyboard. I'm sure I will do better with a joystick.

Ant Attack

With three-dimensional scrolling graphics, fast action and more page flipping, this is another game that probably should not run on a Spectrum. The graphics are not as sharp or colourful as those of Atic Atac or The Snowman, but they would be a credit to most small micros.

In Ant Attack you choose either a boy or a girl — no sexism here — and rush into an Escher-like city to rescue a girl or boy. Giant ants try to stop you. You either avoid them, outrun them or blast them with grenades. The game provides an easy subject to rescue at first, but locating and bringing someone out gets harder and harder.

The main problems with Ant Attack are moving and fighting. Instead of having four direction keys, you have to use one key to turn — Symbol Shift for clockwise, M for anti-clockwise — and another key to move forward. You are not helped by the fact that it is very hard to see in which direction the little figure is facing. On top of this, there are four keys to use according to how far you want to throw a grenade.

The game would be better in another version with four-way directional or joystick control. I would also swap the

(continued on next page)

Game	Publisher	RAM	Price	Rating
Ant Attack	Quicksilva	48K	£6.95	16/20
Atic Atac	Ultimate	48K	£5.50	18/20
Caesar the Cat	Mirrorsoft	48K	£6.95	16/20
Chequered Flag	Sinclair/Psion	48K	£6.95	14/20
Classic Adventure	Melbourne House	48K	£6.95	18/20
Fred	Quicksilva	48K	£6.95	15/20
Micro Mouse goes Debugging	Lothlorien	16 or 48K	£5.95	12/20
Road Racer	Thorn-EMI	16K	£6.95	5/20
Scuba Dive	Durrell	48K	£5.50	16/20
The Snowman	Quicksilva	48K	£6.95	17/20
Speed Duel	DK'tronics	16 or 48K	£5.95	8/20
1984	Incentive	48K	£5.50	16/20

(continued from previous page)
grenades for a machine-gun or sword.
Apart from that, amazing.

Scuba Dive

In Scuba Dive you explore the sea bed, swim over oysters to collect pearls, then squeeze past an octopus into an underwater cavern containing treasure. Technically the graphics are not that good, but they are imaginative and beautiful. They are not as stable as Atic Atac and The Snowman. Also when your aquatic protagonist reaches the edge of the screen, the view shifts suddenly to the next screen. The Atari's single-pixel scrolling in all directions would have done wonders for the game. But after all, it is an underwater game, so it is not unnatural that the fish should shimmer.

The instructions are very good, and the game is very easy to play. Just moving the swimmer about is a pleasure, but it is difficult to score points because when you collect a pearl or 10, the points are scored and held. To get those points you have to get the pearls back to the boat, which is not as easy as it sounds even at the lowest of four skill levels. It certainly builds up the tension, and a good score makes you pleased the game allows you to save the High Score table. All in all, Scuba Dive is an excellent game and the best Durrell effort yet.

Driving crazy

The arcade success of Atari's brilliant Pole Position has thrown the spotlight on driving games, and there are at least three for the Spectrum. The best, by a very long way, is Chequered Flag from Psion. I also tried DK'tronics' Speed Duel and found it poor, and Thorn-EMI's Road Racer, which I found absolutely unplayable.

Chequered Flag is not exactly like Pole

Position, because you get a cockpit view of the track over a set of instruments which the Atari version lacks. The game also provides much more to think about than the Atari one. With Chequered Flag you really have to learn something about gears and the relationship of revs to both heat and speed.

However, Chequered Flag's graphics are inferior to those of Pole Position, and the Sinclair version gives the impression that you are driving at about 1/10th of the speed. Chequered Flag is fun, which is more than can be said for the other two race games. Speed Dual's graphics are much inferior and are so out of scale that it is like having a toy car. Road Racer is even worse, and best not described in a family magazine.

1984

This game has nothing to do with George Orwell, and is not so much a game as a gripping simulation of government management. You start off in 1984 with the U.K. economy, then after with the bank rate, tax, VAT, public expenditure in nine categories, benefits and wage bargaining. At the end of each year you get a report on the state of the country in the form of a balance sheet and histograms.

Initially you try to reduce inflation and unemployment, but that seems to be impossible. Soon you are merely trying to stay in power for as long as possible — just like real life. So far I have either been overthrown or not survived the 1988 election.

The economic model seems excellent, though it is well protected. For example, the program will not allow you to increase VAT by more than 10 percent at a time, so avoiding any large changes that could wreck the simulation. Even so, the model is complex and rugged enough to make the game fun to play, and I would have no hesitation in using it in a school.

Caesar the Cat/ Micro Mouse

Caesar the Cat is one of the few good games on the Commodore 64, and was reviewed in our February issue. The aim of the game is to keep the larder free from mice. The Spectrum version has even more attractive graphics, is far faster, and probably anyone over 16 is already too old for it. Caesar the Cat is recommended, but only to those adults who have access to a Kempston-standard joystick.

Micro Mouse goes Debugging is a novelty game which, like Caesar, is particularly suitable for younger players. The screen shows a short program. Bugs grab characters from the lines, and put them in boxes at the corners of the screen. As Micro Mouse you have to retrieve them. When the program is debugged it runs, and you go on to the next program. Micro Mouse is not a great game, but it is not too hard to play, has smooth movement, attractive graphics, is slightly educational and fun.

Classic Adventure

The latest offering from Melbourne House is always awaited with interest. This month's launch is Classic Adventure, which is the original Crowther and Woods mainframe game. I thought there were already two Spectrum versions, Colossal Adventure from Level 9, and Colossal Caves by Abersoft, published by CP Software. Classic Adventure turns out to be the Abersoft version from 1982.

I agree with Melbourne House that this is "the ultimate in text-only adventures". In fact, I think it is the ultimate in adventures — even better than Zork. Newcomers to the Caves might note that the Melbourne House version is cheaper at £6.95 compared to £9.90, though presumably is not extended. M

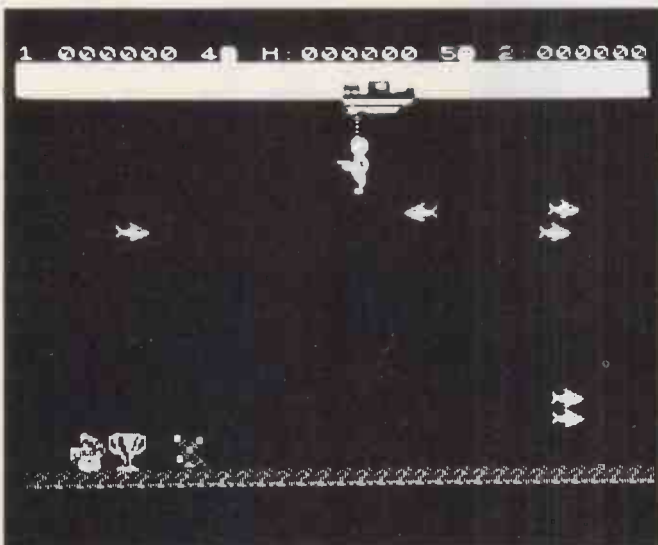

Glug Glug is a shoot'em-up game where you blast the fish while diving for booty on the sea bottom. Unsubtle.

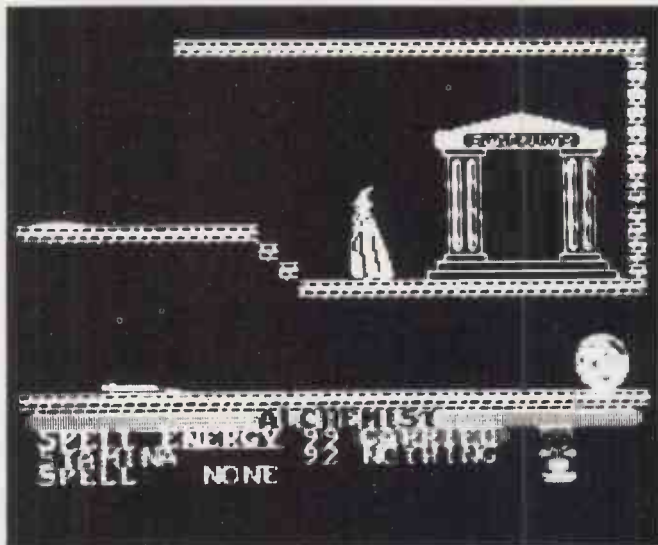

The Alchemist, Imagine's new game, is an arcade-type graphics adventure. Ponderous, but promising.

NEW! From Tandy® -

The TRS-80 Colour Computer 2

"What question must I answer?"

see she wasn't asking the right question. The first step in solving any problem is to ask yourself:



16K Standard
Colour Computer 2

£159⁹⁵

Inc. VAT

26-3026



*Features a Smart White Case and
Low Profile Typewriter-Style Keyboard!*

TRS-80 16K Standard Colour Computer 2. Easily attached to any TV - Program Pak cartridges let you battle starships in outer space - and lots more. But playing games is only the beginning. Your children can learn maths or typing, enjoy literary classics or make glorious computer "paintings". Our entertaining instruction manuals will have you writing programs with colour displays and sound in no time! Colour BASICs simple commands let you quickly produce drawings, diagrams and charts. Choose from eight brilliant colours, create musical tones, solve problems, analyze data and much more, then save your work on tape with an optional cassette recorder, you can easily and quickly add a pair of joysticks and a printer. The standard colour BASIC language includes data and string handling, dimensioned arrays, maths functions and 9-digit numeric accuracy. Includes comprehensive manual.

26-3026 **£159.95**

16K Extended Colour Computer 2. All the features of Standard BASIC, plus advanced programming capabilities to create high-resolution colour graphics using simple one-line commands. **26-3027** **£199.95**

64K Extended BASIC Colour Computer. Gives 32K RAM, or 64K with optional OS-9 Disk Operating System.

26-3003B **£269.95**

Who Is The Colour Computer For? It's ideal for anybody who wants to enjoy video games in a system that can be used for many other household, business and educational tasks. It's great for beginners who want a computer that's easy to learn on - but not limiting - and it's perfect for hobbyists who want a full-features system with the opportunity for advanced graphics and programming expansion.

Tandy

Over 350 Stores
And Dealers
Nationwide

149

Tandy Corporation (Branch UK), Tameway Tower, Bridge St.,
Walsall, West Midlands. WS1 1LA, Tel: 0922-648181

● Circle No. 179

New-Sinclair QL

There's no comparison chart,

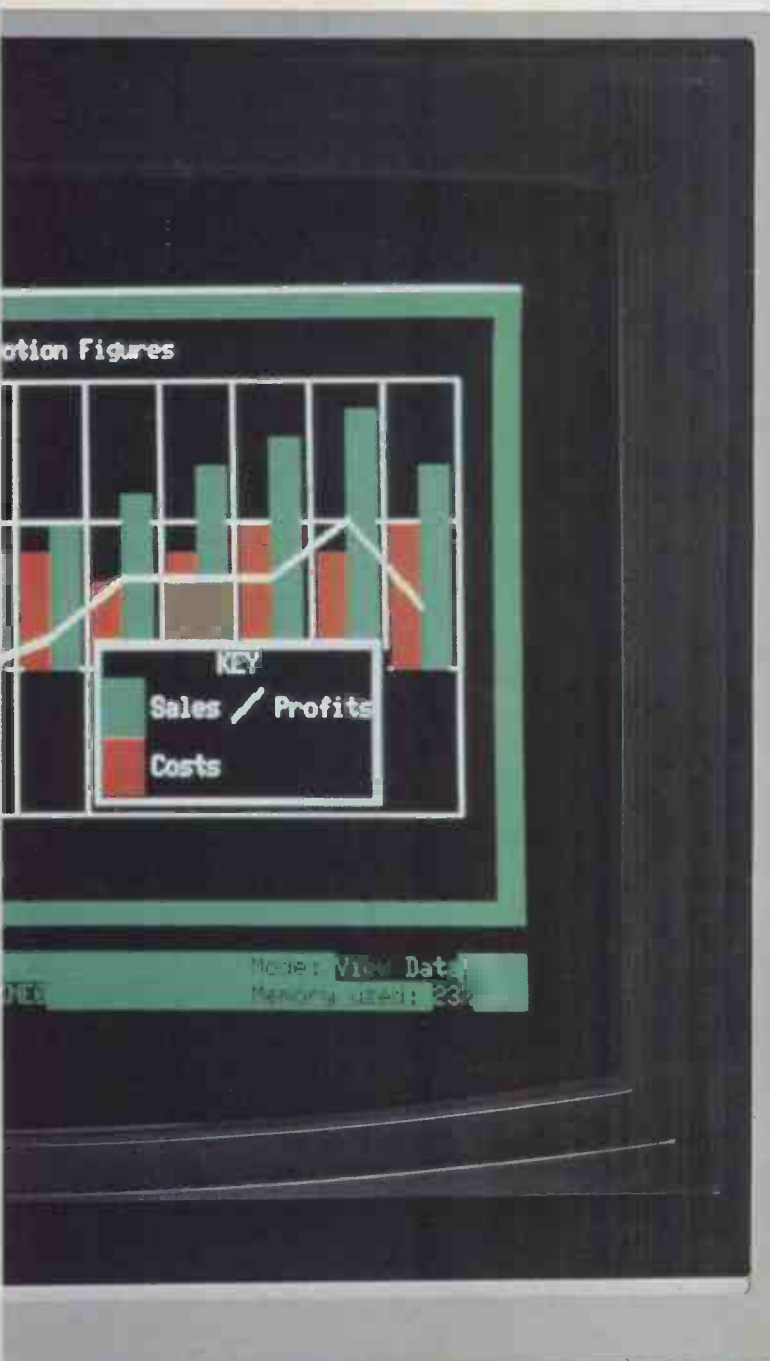

The Sinclair QL is a new computer.

Not just a new Sinclair computer, but a totally new sort of computer – nothing like it exists anywhere.

It's not just a bit better than this, or a bit cheaper than that – it's a computer that's very hard to compare with anything. Just check the features below – and if you don't agree, take up the challenge at the end of the advertisement.

If you do agree, there's only one course of action you can take... get yourself a Sinclair QL at the earliest possible moment.

The Sinclair QL has 128K RAM. Big deal?

Several micros offer 128K RAM, or more, as standard. The 'What Micro?' table for December 1983 lists over 50 of them – but 40 of the 50 micros listed cost over £2,500!

The Sinclair QL offers you 128K RAM for under £400, and an option to expand to 640K. That's a lot of bytes to the pound!

The Sinclair QL has a 32-bit processor. Who else?

Under £2,700, nobody. Even the new generation of business computers, such as the IBM PC, are only now beginning to use 16-bit processors.

At prices like this, the Motorola 68000 family – widely regarded as the most powerful microprocessors available – will remain a luxury.

Yet with the Sinclair QL, the 32-bit Motorola 68008 is available for less than £400.

You can also be sure that the QL will not become outdated. 32-bit architecture is future-proof.

32-bit processor architecture, 128K RAM, and QDOS combine to give the QL the performance of a mini-computer for the price of a micro.

Exclusive: new QDOS operating system

No competition! QDOS sets a new standard in operating systems for the 68000 family of processors, and may well become the industry standard.

QDOS is a single-user, multi-tasking, time-sliced system using Sinclair's new SuperBASIC as a command language.

One of its most significant features is its very powerful multi-tasking capability – the ability to run several programs individually and simultaneously. It can also display the results simultaneously in different portions of the screen. These are features not normally available on computers costing less than £7,000.

Eleven input/output ports

QL ROM Cartridge slot

2 x Joystick ports 2 x RS-232



New professional keyboard

The QL keyboard is designed for fast input of data and programs.

It is a full-size QWERTY keyboard, with 65 keys, including a space bar; left- and right-hand shift keys; five function keys; and four separate cursor-control keys – key action is positive and precise.

A membrane beneath the keyboard protects the machine from dust (and coffee!), and for users who find an angled keyboard more comfortable, the computer can be raised slightly at the back by small detachable feet.

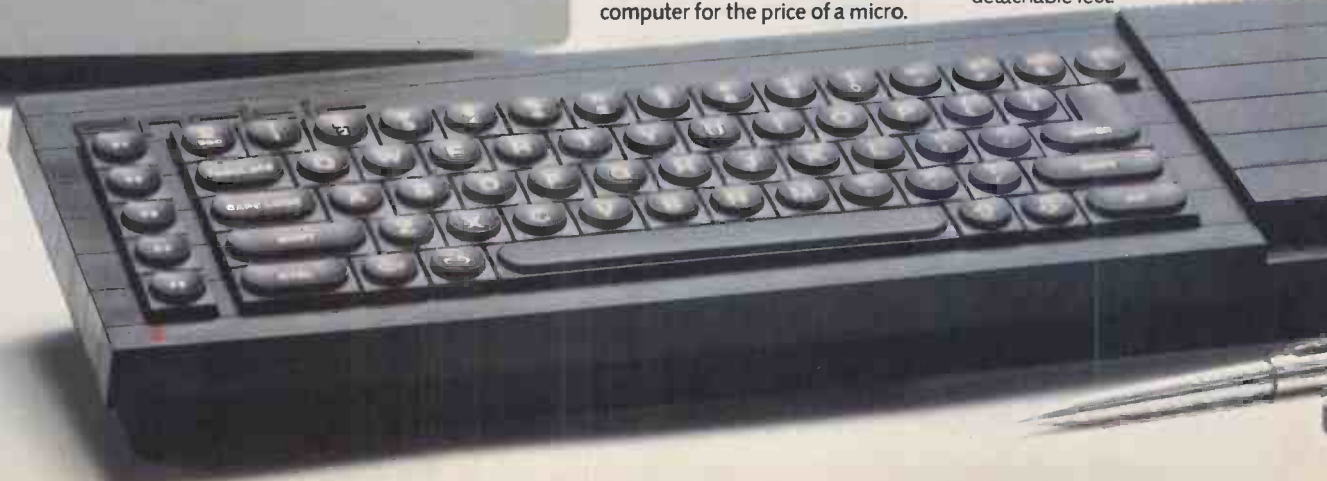

£399

Because there's no comparison!

Advanced new friendly language – Sinclair SuperBASIC

The new Sinclair SuperBASIC combines the familiarity of BASIC with a number of major developments which allow the QL's full power to be exploited.

Unlike conventional BASIC, its procedure facility allows code to be written in clearly-defined blocks; extendability allows new procedures to be added which will work in exactly the same way as the command procedures built into the ROM; and its constant execution speed means that SuperBASIC does not get slower as programs get larger.

Included – superb professional software

The suite of four programs is written by Psion specially for the QL and incorporates many major developments. All programs use full colour, and data is transportable from one to another. (For example, figures can be transferred from spreadsheet to graphics for an instant visual presentation.)

New – the Sinclair QLUB

The QLUB is the QL Users Bureau. Membership is open to all QL owners. For an annual subscription of £35, QLUB members receive one free update to each of the four programs supplied with the QL, and six bi-monthly newsletters. Sinclair has also made exclusive arrangements for QLUB members to obtain software assistance on QL Quill, Abacus, Archive or Easel by writing to Psion.

Word-processing



Certain to set a new standard of excellence, QL Quill uses the power of the QL to show on the screen exactly what you key in, and to print out exactly what you see on the screen.

A beginner can be using QL Quill for word-processing within minutes.

QL Quill brings you all the facilities of a very advanced word-processing package.

Business graphics



QL Easel is a high-resolution colour program so easy to use you probably won't refer to the manual! It handles anything from lines, shaded curves or histograms to overlapping or stacked bars or pie charts. QL Easel does not require you to format your display before entering data; it handles design and scaling automatically or under your control. Text can be added and altered as simply as data.

The Sinclair QL challenge

If you're seriously considering any other computer, post the coupon for a blow-by-blow comparison. We'll take a *published* comparison chart for the machine you're considering (not one we've created ourselves) and give you the Sinclair QL figures, detail by detail.

Take action today!

To order by mail

– complete the coupon and send it to the FREEPOST address below. For credit card holders it may be possible to extend your credit limit. Full details will be sent when we acknowledge your order.

To order by telephone

– phone Camberley (0276) 685311; – have your credit card (Access, Barclaycard, Trustcard) number ready. It may be possible to extend your existing credit limit. Please ask our telephone staff for more details. Please do not use this number for other enquiries.

For more information

Phone Camberley (0276) 686100, or use the coupon to get a QL brochure. Due to demand, delivery may take more than 28 days. Your order will be acknowledged immediately with an expected shipment date. Remember that Sinclair offers a 14-day money-back undertaking.

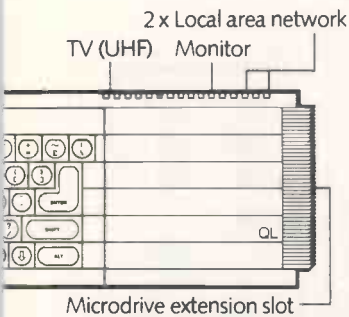

Two 100K microdrives built in

The Microdrives for the Sinclair QL are identical in principle to the popular and proven ZX Microdrives, but give increased capacity (at least 100K bytes each) and a faster data-transfer rate. Typical access speed is 3.5 seconds, and loading is at up to 15K bytes per second. The Sinclair QL has two built-in Microdrives. If required, a further six units can be connected.

Four blank cartridges are supplied with the machine.

Spreadsheet



QL Abacus makes simultaneous calculations and 'what if' model-construction easier than they've ever been. Sample applications are provided, including budget-planning and cash-flow analysis. QL Abacus allows you to refer to rows, columns and cells by names, not just letters and numbers. Function keys can be assigned to change a variable and carry out a complete 'what if' calculation with a single key-stroke.

Database management

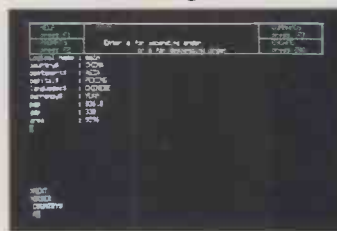

QL Archive is a very powerful filing system which sets new standards, using a language even simpler than BASIC. It combines ease of use for simple applications – such as card indices – with huge power as a multi-file data processor.

An easy-to-use labelling facility means that you don't have to ask for your file by its full name – a few letters are enough.



Send to: Sinclair Research Ltd, Computer Division, FREEPOST, Camberley, Surrey, GU15 3BR.

● Circle No. 180

Qty	Item	Code	Item Price £	Total £
	Sinclair QL Computer	6000	399.00	
	QLUB membership (one year)	6100	35.00	
	Postage & packing (any order over £390)	6999	7.95	

Please tick the appropriate box-

I enclose a cheque made payable to Sinclair Research Ltd for £ _____ £ _____

Please charge my Access/Barclaycard/Trustcard Account No. _____

Signature _____

Mr/Mrs/Miss _____

Address _____

PRC405

Please send me a chart comparing the Sinclair QL computer with a _____

Please send me a Sinclair QL brochure

sinclair

'1984' THE YEAR OF 2000

SAPPHIRE 2000 SERIES REMOTE CONTROL PRINTERS

IMAGINE THE PRINTER OF THE FUTURE... the printer which offers everything. At power-on, miriads of LED'S twinkle their vital information to you. Banks of microswitches on the extended front panel allow selection of the precise option of your choice, and with the aid of touch sensor control switches, you're ready to go. About as easy to operate as Concorde—all simply described in the 3 volume instruction manual.

NOW IMAGINE THE PRINTER BEYOND THE FUTURE... the printer which offers millions of configurations. The printer which needs no tuition or manuals, no exasperating phone calls. The printer which has no switches or LED'S, no control panel.

THE SAPPHIRE 2000... combines sophistication with ingenuity. The result: fast, clear. Perfect simplicity. The Remote Control Unit provides the window through which the operator can select, from the thousands of millions of options, the precise configuration required. Simply, quickly and permanently. Sapphire doesn't forget when you switch it off—it retains the precise options you select for next time.



It even retains more than one set of options—so you can have it set up ready for different jobs. A mere seven buttons allow this, full paper handling options and the usual master controls all from where you sit.

For further details of this revolutionary printer, fill in the coupon below to-day and we will make 1984 the Year of 2000 for you.

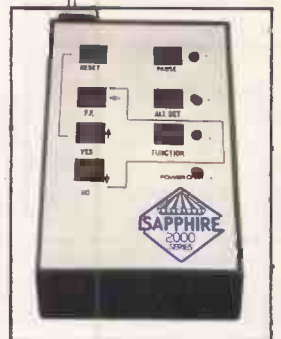

Please send me further details of the SAPPHIRE 2000 SERIES by return.

NAME: _____

ADDRESS: _____

POST CODE: _____

TELEPHONE: _____

MICROPUTE, Catherine Street, Macclesfield,
Cheshire. SK11 6QY.

TELEPHONE: 0625-615384.

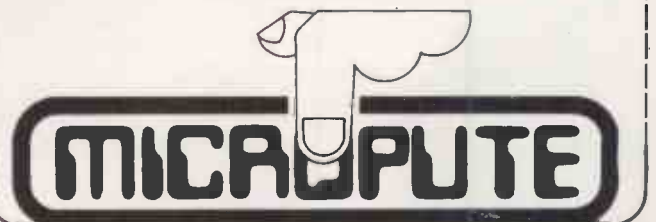

THE YEAR OF THE SAPPHIRE 2000.



SAPPHIRE 2000 SERIES

RESET PAUSE

FF. ALT. SET

YES FUNCTION

NO POWER ON

SAPPHIRE
2000
SERIES

SYMBIOTIC

COMPUTER SYSTEMS LIMITED

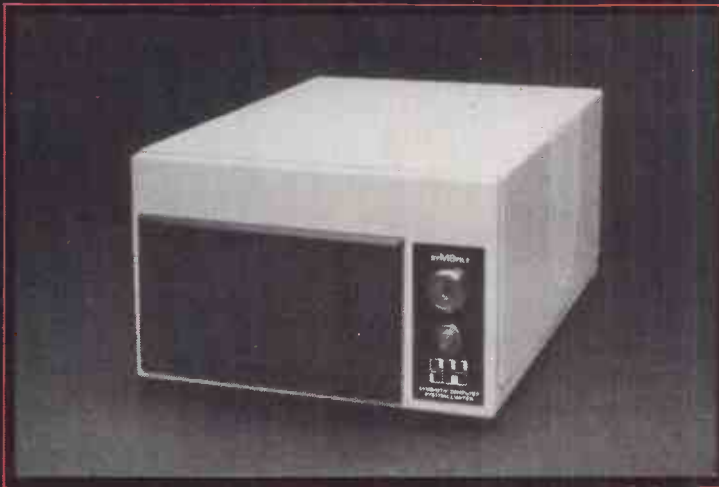

SYMBFILE

5 1/4" WINCHESTER SUB SYSTEM

The SYMBFILE hard disk subsystem is a complete add-on mass storage system for the Apple II, II+, IIe, or III microcomputers and is at present being developed for the SIRIUS, IBM PC and the BBC micro. It is compatible with the majority of hardware products currently available for the Apple, including the 16K Language card and all 80-column cards. SYMBFILES are available in sizes from 5-21 megabytes.

Full DOS, Pascal, and CP/M support allows any standard application software, including database, word processing, and accounting packages to be used.



SYMBSTORE

TAPE STREAMING BACK UP

SYMBSTORE is the perfect complement to SYMBFILE giving a high speed, totally reliable back up system. SYMBSTORE will copy the entire contents of a SYMBFILE to a C60 type digital cassette. SYMBSTORE'S unique multiple buffer verification ensures the perfect transfer of data. Software to individually back up volumes of files under present operating systems will soon be available on request.

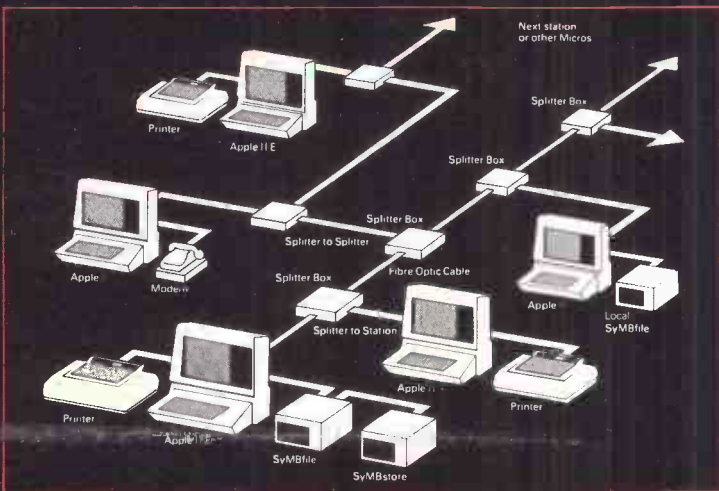

SYMBNET

LOCAL AREA NETWORK

SYMBNET is a "tree and branch" network system using fibre optic cable to allow several microcomputers to share a common SYMBFILE. SYMBNET is the fastest long range local area network for microcomputers, and can cover a range of 7-9 Kilometres. fibre optics means that SYMBNET is more cost effective; it uses a high intensity semi-conductor laser to transmit data and cables can be laid at the shortest route, whereas other networking systems use flat ribbon or coaxial cable which is sensitive to electrical noise from fluorescent lights, photocopiers, etc. SYMBNET is compatible with DOS, Pascal, SOS, and CP/M running on any microcomputer supported by the SYMBFILE in concurrent operation.

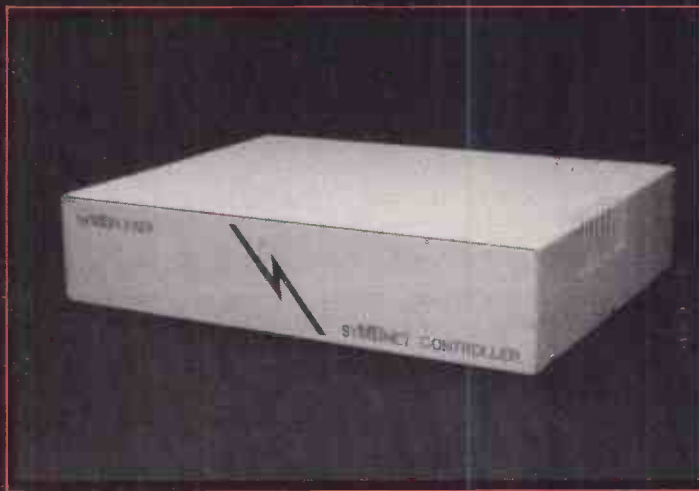

SYMBPLEXER

NETWORK CONTROLLER

The SYMBPLEXER is a network controller which complements SYMBNET. The SYMBPLEXER is connected directly to the SYMBFILE and performs all read-write operations to and from the hard disk. SYMBPLEXER does away with the need for a central machine thus releasing another terminal to run any application you wish. Being a dedicated device the read-write operations are performed very efficiently. The support software allows SYMBPLEXER to designate pass codes for each user and to decide which user may access which applications. If you are currently using SYMBNET, accessing your SYMBFILE via a central machine, the addition of SYMBPLEXER will in no way change the operational capabilities of the network.

For more details of all SYMBIOTIC products contact

ENGLAND
SYMBIOTIC COMPUTER SYSTEMS LTD
DUROMA HOUSE
32 ELMWOOD ROAD, CROYDON
SURREY CR9 3TX
☎ (11) 683 1137 PBX

BENELUX
SYMBIOTIC COMPUTER SYSTEMS
(BENELUX)
KEIZERSGRACHT 26 5611 GD
EINDHOVEN-NEDERLAND
☎ (40) 456055

FRANCE
SYMBIOTIC COMPUTER SYSTEMS
S.A.R.L.
87 RUE LEMERCIER
75017-PARIS-FRANCE
☎ (1) 228 14 18+

NORWAY
SYMBIOTIC COMPUTER SYSTEMS A/S
POSTBOKS 162 OKERNVEJEN
OSLO 5-NORWAY
☎ (47) 2 64 55 77

USA
SYMBIOTIC COMPUTER SYSTEMS
PO BOX 1431
FAIRFIELD CT 06430
☎ (203) 374 5910

The SYMBIOTIC GROUP OF COMPANIES

SYMBIOTIC COMPUTER SYSTEMS LTD · SYMBIOTIC EDUCATIONAL SYSTEMS LTD
SYMBIOTIC COMPUTER SYSTEMS INC · SYMBIOTIC COMPUTER SYSTEMS S.A.R.L.
SYMBIOTIC COMPUTER SYSTEMS (BENELUX) · SYMBIOTIC COMPUTER SYSTEMS A/S

>OPEN FILE

PRACTICAL COMPUTING

MAY 1984

Open File monitors

Apple John Harris
Atari Jack Schofield
BBC Nicholas McCutcheon
Commodore Mike Todd
Dragon Ian Stobie
Epson HX-20 John Wellsman
IBM PC Jack Schofield
Newbrain David Watt
Tandy John Wellsman
Research Machines Ian Stobie
Sharp John Hooper
Sinclair John Wellsman

Open File is the part of the magazine written by the readers of *Practical Computing*. All aspects of microcomputing are covered, from games to serious business software and utilities. Fully-debugged programs can be submitted for any micro, and for standard CP/M machines such as the Osborne and Superbrain. Programs can be in machine code or any language, including Forth and Pascal.

Submissions should include a brief description which explains what your program does, and how it does it. If possible it should be typed, with lines double-spaced. We need a printed program listing. Hand-written listings cannot be accepted. A tape or disc of the program helps if it is in a standard format.

When printing listings, please remember to use a new ribbon or double-intensity printing — faint listings reproduce badly. Use plain paper only, and try to list the program across either a 35-character or a 70-character width. Also, make sure all special graphics or inverse-video characters are either listed correctly or else include Rem statements to explain them fully.

Each program listing, tape or disc must have your name and address on it, or we cannot promise its safe return. A stamped addressed envelope is appreciated.

If you write in with a comment, correction or enquiry please remember to state the machine and the program title.

We pay at least £10 for any programs used, or £35 per page and pro rata for part pages.

>COMMODORE

156 HI-LO CARD GAME

A Pet version of the popular television programme *Play your Cards Right*, written by G Pounder. Excitement is added to the game by a cash prize provided at the end of a successful run.

156 BOMBING MONSTERS

Modifications for Thomas and Kim Gustafsson's game which appeared in February's Open File.

157 HIGH-RESOLUTION SKETCH PAD

A simple sketching program from Ian Metcalf, which demonstrates the high-resolution capabilities of the Commodore 64 and has plenty of scope for speed improvements.

>SINCLAIR

159 COUNT TO EIGHT

Another game from Charles Cowan, written for the 16K Spectrum.

159 SOLVER

K D Drew has supplied a program for solving simultaneous equations. Although written for the ZX-81, with a few modifications it could run on any computer.

160 EYESIGHT SAVER

C P Marriner's small routine helps to make your program listings more readable. It shakes up a program of multi-statement lines so that each statement is on a new line.

>RESEARCH MACHINES

161 TANGLE WITH TANKS

A fast, challenging game written in Basic for the 380Z by Mark Callaway. You control a tank and try to keep going as long as possible by avoiding obstacles in your way.

>TANDY

163 PERFECT MAZES

You can while away your time getting lost with this program from R English.

163 MEMORY MAP

A detailed memory map for the Tandy Model 1.

163 GENIE TIPS

A J Brier supplies a handful of helpful hints to aid in programming the Genie.

163 SOUND ADVICE

With the help of an amplifier and a speaker you can obtain sound on the Model I or III with the information supplied by Norman Bailey.

>BBC

165 BERTIE THE BEETLE

Enter the insect world with this game from William Prew. You play the hero, Bertie the Beetle, and help your loved one, Suzy the Snail, to get back her children who have been taken away.

165 MOVING PYRAMID

A very short graphics program from Simon Pithers to enable you to draw a pyramid.

>NEWBRAIN

167 SCREEN HOLD

I G Bernard provides a machine-code routine which enables the little-used Videotext key to be used for suspending and restarting display — especially handy when you want to list long programs.

>APPLE

169 NOUGHTS AND CROSSES

A game particularly suitable for playing with young children to introduce them to using a computer.

Send your contribution to:

Open File, Practical Computing,
Quadrant House, The Quadrant,
Sutton, Surrey SM2 5AS

Hi-lo card game

THIS IS A PET VERSION of the popular television programme *Play your Cards Right* but it has two ingredients missing. There is no Bruce Forsyth and there are no questions to be answered other than "Is the next card higher or lower?"

The program presents five cards, all face down, and then turns up the first. you have to decide if the next card is going to be higher or lower, and if you are correct this is repeated until all five cards have been turned over correctly.

To add a little spice to the game, its writer, G Pounder of Blackpool, has provided a cash prize at the end of a successful run. The amount won depends upon the cards turned over and is up to a maximum of £2 for a straight flush. Unlike the television version, there is no opportunity to change the first card, and two cards of the same value are ranked according to suit.

Programs which use a variety of the graphics features of the Pet are often difficult to type from the listings. All the cursor-control characters have therefore been converted and placed inside the square brackets, with all spaces in quotes replaced by the small triangles.

The program contains the instructions and has plenty of Rems, so it should be easy to understand. It will work on all Pets, and also on the 64 provided that the Pokes in lines 174, 218 and 222 are replaced as follows

POKE 59468, 14 BY PRINT CHR\$(14);
POKE 59468, 12 BY PRINT CHR\$(142);

Bombing Monsters

There were several unusual features in the Thomas and Kim Gustafsson's Bombing Monster game in the February Open File. Not least was a minor error in line 3060 which should have read Run98 rather than Run50. It will not have stopped the game running, just prevented you from having a second game.

Another feature was that the screen size

Bombing monsters.

```
10 POKE 7232,0
100 POKE 56,28: POKE 52,28: CLR
150 POKE 36869,255
160 FOR I=0 TO 7: POKE 7168+I,0: NEXT
170 FOR I=0 TO 4: READ A: POKE 7176+I,A:NEXT
200 FOR I=0 TO 7: POKE 7224+I,255: NEXT
492 FOR I=37888 TO 37955: POKE I,1: NEXT
495 FOR I=7233 TO 7834: POKE I,0: NEXT
```

```
5031 CHANGE 5184 TO 7232 (2 TIMES)
5032 CHANGE 5184 TO 7232 (ONCE)
7060 CHANGE RUN50 TO RUN98
```

DELETE LINES:
190, 210, 230, 250, 270

```
11 B$="[RV$]PRESS ANY KEY TO CONTINUE
  OR [X] TO EXIT[RV$]"
13 Z$="HOME,DOWN2]"
14 MO=100:DIM P(15)
15 PRINT"[CLEAR]INSTRUCTIONS?A<[Y/N]
16 A$=""
17 GET A$:IF A$="" THEN 17
18 IF A$="Y" THEN 174
19 PRINT"[CLEAR]"
20 REM-INITIALISE VARIABLES
21 W=1:X=0:CA=0:PA=0:MI=0:J=0:J1=0
  :Z2=0
22 H=0:C=0:S=0:D=0:OU$=""
23 REM-COST OF EACH TURN
24 MO=MO-10
25 REM-PICK 5 CARDS AT RANDOM
26 FOR A=1 TO 14:P(A)=0:NEXT A
27 REM-SET UP PACK OF CARDS
28 P$="022#033#044#055#066#077#088#09
  9#10#11J#12Q#13K#14A#"
29 P$=P$+"022#033#044#055#066#077#088
  #099#10T#11J#12Q#13K#14A#"
30 P$=P$+"022#033#044#055#066#077#088
  #099#10T#11J#12Q#13K#14A#"
31 P$=P$+"022#033#044#055#066#077#088
  #099#10T#11J#12Q#13K#14A#"
32 R2=INT(1000#RND(-RND(0)))
33 R=INT((51-X)#RND(R2))
34 R1=4#R
35 X=X+1
36 CA$(X)=MID$(P$,R1+1,4)
37 IF R1=0 THEN R1=1
38 REM-SHRIK PACK OF CARDS
39 TE$(1)=MID$(P$,1,R1-1)
40 TE$(2)=MID$(P$,R1+4)
41 P$=TE$(1)+TE$(2)
42 ST$(X)=RIGHT$(CA$(X),1)
43 CD$(X)=MID$(CA$(X),3,1)
44 REM-SET VALUE OF SUIT FOR CARDS
45 IF ST$(X)="#" THEN S=S+1:Z(X)=4
  :GOTO 49
46 IF ST$(X)="#" THEN H=H+1:Z(X)=3
  :GOTO 49
47 IF ST$(X)="#" THEN D=D+1:Z(X)=2
  :GOTO 49
48 C=C+1:Z(X)=1
49 P1=VAL(LEFT$(CA$(X),2))
50 R(X)=P1
51 P(X1)=P(X1)+1
52 REM-REPEAT UNTIL 5 CARDS PICKED
53 IF X<5 THEN 32
54 REM-DISPLAY BACK OF CARDS
55 PRINT"[HOME,RIGHT3]PRESS[RV$]H
  [RV$] FOR HIGHER OR [RV$]L[RV$]
  FOR LOWER"
56 PRINT"[HOME,DOWN3]"
57 PRINT"[RV$] [RV$] [RV$] [RV$] [RV$]
  [RV$] [RV$] [RV$] [RV$] [RV$]
  [RV$] [RV$] [RV$] [RV$] [RV$]"
58 PRINT"[RV$] [RV$] [RV$] [RV$] [RV$]
  [RV$] [RV$] [RV$] [RV$] [RV$]
  [RV$] [RV$] [RV$] [RV$] [RV$]
  [RV$] [RV$] [RV$] [RV$] [RV$]"
59 PRINT"[RV$] [RV$] [RV$] [RV$] [RV$]
  [RV$] [RV$] [RV$] [RV$] [RV$]
  [RV$] [RV$] [RV$] [RV$] [RV$]
  [RV$] [RV$] [RV$] [RV$] [RV$]
  [RV$] [RV$] [RV$] [RV$] [RV$]"
60 PRINT"[RV$] [RV$] [RV$] [RV$] [RV$]
  [RV$] [RV$] [RV$] [RV$] [RV$]
  [RV$] [RV$] [RV$] [RV$] [RV$]
  [RV$] [RV$] [RV$] [RV$] [RV$]"
61 PRINT"[RV$] [RV$] [RV$] [RV$] [RV$]
  [RV$] [RV$] [RV$] [RV$] [RV$]
  [RV$] [RV$] [RV$] [RV$] [RV$]
  [RV$] [RV$] [RV$] [RV$] [RV$]
  [RV$] [RV$] [RV$] [RV$] [RV$]"
62 PRINT"[RV$] [RV$] [RV$] [RV$] [RV$]
  [RV$] [RV$] [RV$] [RV$] [RV$]"
63 PRINT"[RV$] [RV$] [RV$] [RV$] [RV$]
  [RV$] [RV$] [RV$] [RV$] [RV$]
  [RV$] [RV$] [RV$] [RV$] [RV$]
  [RV$] [RV$] [RV$] [RV$] [RV$]
  [RV$] [RV$] [RV$] [RV$] [RV$]"
64 PRINT"[RV$] [RV$] [RV$] [RV$] [RV$]
  [RV$] [RV$] [RV$] [RV$] [RV$]
  [RV$] [RV$] [RV$] [RV$] [RV$]
  [RV$] [RV$] [RV$] [RV$] [RV$]"
65 REM-SET VARIABLES FOR OUTPUT OF FR
  ONT OF CARD
66 X=1
67 ST$=ST$(X)
68 O1$="[RV$] [RV$] [RV$] [RV$] [RV$]"
69 O2$="[RV$] [RV$] [RV$] [RV$] [RV$]"
70 O3$="[RV$] [RV$] [RV$] [RV$] [RV$]"
  :O1$=O1$+"ST$+"
  :O2$=O2$+"ST$+"
  :O3$=O3$+"ST$+"
  :O1$=O1$+"ST$+"
  :O2$=O2$+"ST$+"
  :O3$=O3$+"ST$+"
71 L1$="[RV$] [RV$] [RV$] [RV$] [RV$]"
72 L7$="[RV$] [RV$] [RV$] [RV$] [RV$]"
73 REM-DESIGN FRONT OF CARD
74 VV=VAL(LEFT$(CA$(X),2))
75 IF VV=14 THEN VV=1
76 FOR A=1 TO 7:A$(A)="[RV$] [RV$] [RV$] [RV$] [RV$]"
  :GOTO 90
77 IF VV=1 THEN A$(4)=O1$:GOTO 90
78 IF VV=3 OR VV=5 THEN A$(4)=O1$
79 IF VV=2 OR VV=3 THEN A$(2)=O1$
  :A$(6)=O1$:GOTO 90
80 IF VV=7 OR VV=8 THEN A$(3)=O1$
81 IF VV=8 THEN A$(5)=O1$:GOTO 83
82 IF VV=10 OR VV=11 THEN A$(3)=O2$
  :A$(5)=O2$
83 IF VV<3 AND VV<9 THEN A$(2)=O2$
  :A$(6)=O2$
84 IF VV<5 AND VV<13 AND VV<9 AND VV
  <11 THEN A$(4)=O2$
85 IF VV<9 THEN 90
86 IF VV=9 THEN A$(2)=O3$:A$(4)=O3$
  :A$(6)=O3$:GOTO 90
87 IF VV=11 OR VV=13 THEN A$(4)=O3$
88 IF VV=11 THEN A$(3)=O3$:A$(5)=O3$
89 REM-OUTPUT FRONT OF CARD
90 PRINT"[HOME,DOWN3]"
91 FOR A=1 TO 7
92 IF A=1 THEN PRINT TAB((X-1)*8):L1$
  :GOTO 95
93 IF A=7 THEN PRINT TAB((X-1)*8):L7$
  :GOTO 95
94 PRINT TAB((X-1)*8):A$(A)
95 NEXT A
96 REM-BRANCH ON WRONG ANSWER
97 IF J1=1 THEN 125
98 IF X=5 THEN J=1:GOTO 118
99 REM-GET HIGHER OR LOWER RESPONSE
100 R$=""
101 GET R$:IF R$="" THEN 101
102 IF R$="H" OR R$="L" THEN 105
103 GOTO 100
104 REM-TEST FOR CORRECT ANSWER
105 IF R(X)>R(X+1) AND R$="L" THEN 111
106 IF R(X)<R(X+1) AND R$="H" THEN 111
107 IF R(X)=R(X+1) AND Z(X)<Z(X+1) AND
  R$="H" THEN 111
108 IF R(X)=R(X+1) AND Z(X)>Z(X+1) AND
  R$="L" THEN 111
109 REM-SET MARKER FOR WRONG RESPONSE
110 J1=0:GOTO 112
111 IF X=5 THEN J=1
112 X=X+1
113 REM-OUTPUT RESPONSE GIVEN
114 IF R$="H" THEN R$="HIGHER"
  :GOTO 117
115 R$="LOWER"
117 PRINT"[HOME,DOWN1,RIGHT]"
  TAB((X-1)*8):R$
118 IF J=1 THEN 151
119 REM-OUTPUT WRONG RESPONSE
121 IF J1=1 THEN PRINT"[HOME,DOWN14]"
  "WRONG RESPONSE!!!"
122 REM-BRANCH TO DISPLAY OF CARD
123 GOTO 67
124 REM-UPDATE MONEY AND OUTPUT MONEY
  LEFT
125 MO=MO+MI
126 IF MO<95 THEN K$="PENCE"
  :GOTO 129
127 K$="POUND":MO=MO/100
129 PRINT"[HOME,DOWN23]"
  MONEY LEFT:="":MO:K$
130 IF K$="POUND" THEN MO=MO*100
131 REM-END OF GAME WHEN MONEY = 0
132 IF MO=0 THEN PRINT"[CLEAR,DOWN5]"
  NO MONEY LEFT IN YOUR ACCOUNT".END
133 REM-ANOTHER GAME?
134 PRINT"[UP5] DO YOU WANT TO PL
  Y ANOTHER GAME?"
135 Q$=""
136 GET Q$:IF Q$="" THEN 136
137 IF Q$="N" THEN 143
```

is increased beyond the normal 22 by 23 characters. This is done with the Pokes in lines 110 to 140, with line 150 setting up the repositioned character generator. In this case the screen memory now starts at 7168 and colour at 37888.

The game was designed to run on a Vic-20 with the 3K RAM expansion pack fitted, although it can be converted to run on an unexpanded Vic. I am grateful to Richard Whiteley of Hamilton for the necessary modifications given in the listing.

High-resolution sketch pad

This simple sketching program, written by Ian Metcalf of Preston, demonstrates the high-resolution capabilities of the Commodore 64. It uses a joystick plugged into games port number 1 to draw lines on the screen. When the Fire button is pressed, the program draws the line in the same colour as the screen so that lines can be removed. Alternatively, the cursor, can be moved to a different part of the screen.

The Clear Screen key will clear the screen, but leaves the cursor where it was. Pressing Ctrl-Z resets the video chip and aborts the program; the machine will then need to be reset using the Stop and Restore keys.

The program itself is in lines 100 to 140, with most of the processing being done as subroutines. The Data statements in lines 20000 to 20070 contain a short machine-code program which is used to clear the high-resolution screen.

The subroutine at 30000 does the actual plotting of the point on the screen. The colour is determined by the expression $CO + 16$ in line 30040. If a colour other than white is required it can be changed to $CO + (16 * \text{colour code})$

The background colour can be changed by amending line 110 so that CO is equal to the value of colour code, and by changing the Poke 826,0 in line 30390 to Poke 826,CO.

Lines 30100 to 30150 set up the video chip as required, and lines 30200 to 30230 set up the machine-code routine from the Data statements. The joystick routine starts at line 30300 and sets up the X and Y coordinates and plotting mode as required.

Like many programs that are fairly easy to understand, this one has plenty of scope for significant speed improvements. For instance, the calculation of BI in line 30020 takes a long time and could be replaced by setting up an array containing all possible values of BI. There are actually only eight of them since X2 is in the range 0 to 7.

Another possibility is to replace some of the numeric values with variables. It often takes quite a long time for the Commodore 64 to read a number from the program and convert it into binary. If it is assigned to a variable at the very start of the program, the conversion has already been performed once and for all.

```

138 REM-PLAYER DOES NOT WANT TO CONTINUE TO PLAY
139 PRINT"[CLEAR,DOWN5]
      THANK YOU FOR PLAYING."
140 PRINT"[DOWN]YOUR ACCOUNT NOW STANDS AT ";MO;" PENCE." :END
141 REM-ERASE TITLES DISPLAYED
143 PRINT"[HOME,DOWN23]
      *****
144 PRINT"[UP5,RIGHT3]
      *****
145 PRINT"[UP5]*****
      *****
146 PRINT"[UP3]*****
      *****
147 PRINT"[UP4]*****
      *****
148 PRINT"[DOWN8]*****
      *****
149 GOTO 21
150 REM-CALCULATE WIN
151 FOR A=2 TO 14
152 IF P(A)=2 THEN PA=PA+1
153 IF P(A)=3 THEN CA=1
154 IF P(A)=4 THEN CA=2
155 NEXT A
156 IF CA=1 AND PA=1 THEN WI=150
   :OU$="A FULL HOUSE":GOTO 166
157 IF PA=2 THEN WI=60:OU$="2 PAIRS"
   :GOTO 166
158 IF CA=1 THEN WI=100
   :OU$="3 OF A KIND":GOTO 166
159 IF CA=2 THEN WI=200
   :OU$="4 OF A KIND":GOTO 166
160 IF PA=1 THEN WI=40:OU$="A PAIR"
   :GOTO 166
161 OU$="NOTHING":WI=20
162 IF S=5 OR H=5 OR C=5 OR D=5 THEN
   WI=150:OU$="A FLUSH":F=1
163 IF R(1)>10 THEN 166
164 IF R(1)+1=R(2)AND R(3)+1=R(4)AND
   R(5)=R(1)+4 THEN WI=150
   :OU$="A STRAIGHT":S=1
165 IF F=1 AND S=1 THEN WI=200
   :OU$="A STRAIGHT FLUSH"
166 IF WI<90 THEN K$="PENCE."
   :GOTO 169
167 K$="POUND." :WI=WI/100
168 REM-OUTPUT TOTAL OF CARDS AND DIS
   PLAY ASSOCIATED WIN
169 PRINT"[HOME,DOWN14]
      CARDS TOTAL "OU$
170 PRINT"[DOWN]THIS IS WORTH ";WI;K$
171 IF K$="POUND." THEN WI=WI*100
172 GOTO 125
173 REM-SET LOWER CASE
174 POKE 59468,14
175 REM-INSTRUCTIONS
176 PRINT"[CLEAR]";TAB(11);
      "*****HI ^-LO*****"
177 PRINT"[DOWN]THE OBJECT OF THE GAME
      IS TO FORECAST
178 PRINT"[DOWN]WHETHER THE NEXT CARD
      WILL BE HIGHER OR
179 PRINT"[DOWN]LOWER THAN THE PRECED
      ING ONE.
180 PRINT"[DOWN2]IF THIS PROCESS IS
      SUCCESSFULLY ARCHIVED
181 PRINT"THEN THE COMPUTER WILL REWA
      RD YOU WITH A
182 PRINT"CASH WIN IN THE RANGE OF $0
      .20 TO $2.00
183 PRINT"[DOWN]CORRESPONDING TO THE
      DIFFICULTY INVOLVED
184 PRINT"IN THE FORECASTING PROCESS.
185 PRINT Z$;B$
186 GOSUB 220
187 PRINT"[CLEAR]";TAB(11);
      "*****HI ^-LO*****"
188 PRINT"[DOWN]THE WINNINGS ARE CA
      LCULATED ON THE
189 PRINT"[DOWN]FOLLOWING SCALE: -
190 PRINT"[DOWN]NOTHING *****$
      0.20
191 PRINT"1 PAIR *****$0.40
192 PRINT"2 PAIR *****$0.60
193 PRINT"3 OF A KIND *****$1.00
194 PRINT"FULL HOUSE *****$1.50
195 PRINT"STRAIGHT *****$1.50
196 PRINT"FLUSH *****$1.50
197 PRINT"4 OF A KIND *****$2.00
198 PRINT"STRAIGHT FLUSH *****$2.00
199 PRINT"[DOWN2]YOU START THE GAME
      WITH $1.00 AND THE
200 PRINT"[DOWN]COST OF EACH TURN IS
      $0.10."
201 PRINT Z$;B$
202 GOSUB 220
203 PRINT"[CLEAR]";TAB(11);
      "*****HI ^-LO*****"
204 PRINT"[DOWN]NOTE:-
205 PRINT"[DOWN2]ACE IS HIGH
206 PRINT"[DOWN]IF TWO CONSECUT
      IVE CARDS ARE EQUAL
207 PRINT"THEN THE CARD SUITS HAVE TH
      E FOLLOWING
208 PRINT"[DOWN]HEIGHTS:-
209 PRINT"[DOWN]SPADES<>>
      HEARTS
210 PRINT"[DOWN]HEARTS<>>
      DIAMONDS
211 PRINT"[DOWN]DIAMONDS<>>
      CLUBS
212 PRINT Z$;" [RV$]
      PRESS ANY KEY TO BEGIN GAME [RV$]
      "
214 REM-BEGIN GAME
215 A$=""
216 GET A$:IF A$="" THEN 216
217 REM-REPLACE TEXT TO UPPER CASE
218 POKE 59468,12:GOTO 19
219 REM-SUB. TO CONTINUE INSTRUCTIONS
      OR BEGIN GAME
220 A$=""
221 GET A$:IF A$="" THEN 221
222 IF A$="X" THEN POKE 59468,12
      :GOTO 19
223 RETURN

```

Sketch pad.

```

100 GOSUB 30200
105 POKE 650,128
110 CO=0: GOSUB 30100: X=160: V=100

120 RU=1: GOSUB 30300
130 GOSUB 30000
140 GOTO 120

20000 DATA 173,0,221,41,254,141,0,221,
169,8,141
20010 DATA 24,208,173,17,208,9,32,141,
17,208
20020 DATA 32,89,3,96,165,176,72,165,
177,72
20030 DATA 169,96,133,177,169,0,133,
176,162,32
20040 DATA 160,0,145,176,136,208,251,
230,177,202
20050 DATA 208,244,169,64,133,177,173,
58,3,162
20060 DATA 4,160,0,145,176,136,208,
251,230,177
20070 DATA 202,208,244,104,133,177,
104,133,176,96,999

30000 Y1=INT(Y/B): Y2=Y-Y1*B
30010 X1=INT(X/B): X2=X-X1*B
30020 CH=Y1*320 + X1*B + Y2
      : BI=2^(7-X2)
30030 POKE 24*1024+CH,
      PEEK(24*1024+CH) OR BI
30035 IF RU=0 THEN POKE 24*1024+CH,
      PEEK(24*1024+CH) AND 255-BI
30040 POKE 16*1024+X1+40*Y1, CO+16
30050 RETURN

30100 VC=13*4096 + 13*256: V=13*4096
30110 POKE VC,PEEK(VC) AND 254
30120 POKE V+24,B
30130 POKE V+17,PEEK(V+17) OR 32
30140 POKE 826,CO: SYS(832)
30150 RETURN

30200 I=832
30210 READ A: IF A=999 THEN RETURN
30220 POKE I,A
30230 I=I+1: GOTO 30210
30300 JO=PEEK(56321) AND 31
30310 IF (JO AND 1)=0 THEN Y=Y-1
30320 IF (JO AND 2)=0 THEN Y=Y+1
30330 IF (JO AND 4)=0 THEN X=X-1
30340 IF (JO AND 8)=0 THEN X=X+1
30345 IF (JO AND 16)=0 THEN RU=0
30350 IF X<=1 THEN X=X+320:GOTO 30390
30360 IF X>=320 THEN X=X-320
      :GOTO 30390
30370 IF Y<=1 THEN Y=Y+199
      :GOTO 30390
30380 IF Y>=199 THEN Y=Y-198

30390 POKE 167,0: GET A$
      :IF A$="[CLEAR]" THEN POKE 826,0
      :SYS 832
30395 IF A$=CHR$(26) THEN POKE VC,151
      :POKE V+24,21:POKE V+17,27:END
30400 RETURN

```

DISKPOST

* BETTER VALUE MAIL ORDER SUPPLIES FOR YOUR MICRO *

TDK DISKS



High grade flexible disks from one of the world's most famous suppliers. 5 1/4" and 8" disks, in boxes of 10.

5.25" DISKETTES

M1D-S	S/S, D/D, 48 TPI	£24.30
M2D-S	D/S, D/D, 48 TPI	£34.80
M2DX-S	D/S, D/D, 96 TPI	£45.50

48 TPI suitable for 35 or 40 track operation.
96 TPI suitable for 77 or 80 track operation.

8" DISKETTES

F1-S128	S/S, S/D	£27.60
F1-H32	S/S, S/D	£27.60
F2D-S1024	D/S, D/D	£40.10

DATALIFE DISKS



From Verbatim, the world's leading diskette manufacturer. Full 5 year warranty. All minidisks are certified for double density recording, and are fitted with hub ring reinforcement as standard.

Prices per box of 10 disks.

5.25" DISKETTES

MD525	S/S, D/D, 48 TPI	£18.25
MD550	D/S, D/D, 48 TPI	£27.15
MD577	S/S, D/D, 96 TPI	£25.55
MD577	D/S, D/D, 96 TPI	£34.20

48 TPI suitable for 35 or 40 track operation.
96 TPI suitable for 77 or 80 track operation.
10 and 16 hard sectored versions available at same prices.

8" DISKETTES

FD34-9000	S/S, S/D	£26.10
FD34-8000	S/S, D/D	£26.60
DD34-4001	D/S, D/D	£30.95

32 hard sectored versions available at same prices.

XIDEX DISKS



The new premier quality standard, against which all other manufacturers will have to be judged. All products certified for double density recording. Now with a lifetime warranty. Unreservedly recommended.

Prices per box of 10 disks.

5.25" DISKETTES

5012-1000	S/S, D/D, 48 TPI	£19.55
5022-1000	D/S, D/D, 48 TPI	£27.55
5012-2000	S/S, D/D, 96 TPI	£27.75
5022-2000	D/S, D/D, 96 TPI	£35.80

48 TPI suitable for 35 or 40 track operation.
96 TPI suitable for 77 or 80 track operation.
10 and 16 hard sectored versions available at same prices.

8" DISKETTES

8012-1000	S/S, D/D	£26.40
8022-1000	D/S, D/D	£31.90

32 hard sectored versions available at same prices.

TDK CASSETTES



You know the name and the quality's the same. 15-minute computer grade cassettes for optimum performance in all standard microcomputer cassette drives. In boxes of 10.

TDK PC15 £5.90

DISK DRIVE HEAD CLEANING KITS



Helps to protect your valuable data, and minimise expensive downtime and repair costs. Consists of a flexible jacket, which receives a pre-saturated cleaning disk. Each disk is sealed within a foil sachet to ensure that it contains the right quantity of cleaning fluid when used. After use the disk is disposed of, and the jacket is kept for future use.

Suitable for single or dual head drives. Please specify 8" or 5.25" disks.

STARTER KIT £7.70
(contains jacket and two cleaning disks)

REPLACEMENT CLEANING KITS £14.80
(pack of 10)

DISKETTE STORAGE BOXES

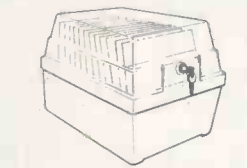

Protect your diskettes and valuable data from external contamination. Lockable, portable and secure. Two part box made from anti-static ABS plastic. Price includes dividers and index labels. Capacity 80 disks.

A5 Storage box (for 8" disks) £32.00

A6 Storage box (for 5.25" disks) £22.00

CTI - CP80 PRINTER



Features:-

- Friction and tractor feed as standard 80 c.p.s.
- Bi-directional logic seeking.
- 13 x 9 dot matrix giving true descenders. Sub and superscripts.
- Italic printing and auto underlining.
- Condensed, emphasised, expanded and double strike printing (can be mixed in a line).
- Parallel interface fitted as standard.
- 12 month warranty.

Print sample available on request.

CP-80 PRINTER £249.00

Optional RS-232 Interface £40.00

Special VIC20/VIC 64 Interface £46.00

PRINTER STAND

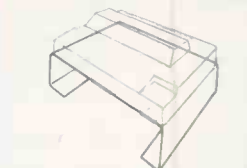

Suitable for use with dot matrix printers. Lifts printer sufficiently to enable continuous stationery to self-stack. Painted steel unit.

Dimensions: 39cm wide
x 28cm deep
x 10cm high

Comes as package which also contains:-

- 200 sheets continuous stationery.
- 1 x 9 1/2" binder.
- 1 x highlighter pen.
- choice of rubber feet/sticky pads.

PRINTER STAND £19.95

COMPUTER FURNITURE



Suitable for use with all leading personal computers. Features a top shelf for monitor/printer, lower shelf for books, paper and general storage; large desk top surface at keyboard height; attractive teak finish, and castors for mobility.

U.K. Manufacture. Comes in flat pack for self assembly - full instructions provided.

A further range of more sophisticated units is available - please ask for details.

THE ORGANISER £55.00

To: DISKPOST, FREEPOST, WEST MOLESEY, SURREY, KT8 0QF. Tel: 01-941 4066

All prices inclusive of delivery and insurance on British mainland.

Qty	Product	Price
.....	£
.....	£
.....	£
.....	£
Sub Total		£
Delivery/Insurance		£ FREE
V.A.T.		£
TOTAL VALUE OF CHEQUE PAYABLE TO DISKPOST		£

YOUR NAME

ADDRESS

Tel. No.:

Please charge to my Visa/Mastercharge/American Express/Diners Club account.

My card number is

Credit Card Orders

We welcome Visa, (Barclaycard), Mastercharge, (Access), Diners Club and American Express. There is no credit card surcharge. Either write your card number on your order, or telephone your order to our sales office.

* NEW 1984 PRICES * DISKPOST

DISKPOST* is the mail order division of the BFI Electronics Group Europe's largest independent diskette supplier.

FREEPOST West Molesey Surrey KT8 0QF. Tel: 01-941-4066

Count up to eight

```

10 REM **** EIGHTS ****
20 PRINT "THE OBJECT IS TO MAKE AS LONG A WORD AS POSSIBLE FROM 8 RANDOM ": PRINT "VOWELS OR CONSONANTS "
30 PRINT "You have 30 seconds for each selection of words"
40 PRINT "SCORE 1 POINT FOR EACH LETTER OF YOUR WORD, AND 5 FOR THE WINNING WORD, OR 5 POINTS EACH IN THE ": PRINT "CASE OF A TIE"
50 PRINT "TYPE S TO START"
60 IF INKEY$="s" THEN GO TO 80
70 GO TO 60
80 CLS
90 LET b=1: LET d=1
100 RANDOMIZE
110 LET t1=0: LET t2=0
120 FOR i=1 TO 10
130 LET b=1: LET d=1
140 IF INT (i/2)<>i/2 THEN PRINT "PLAYER 1 SELECT 8 LETTERS"
150 IF INT (i/2)=i/2 THEN PRINT "PLAYER 2 SELECT 8 LETTERS"
160 PAUSE 50
170 FOR k=1 TO 8
180 INPUT "TYPE V FOR A VOWEL, C FOR A CONSONANT",l$
190 IF l$<>"v" AND l$<>"c" THEN GO TO 180
200 IF l$="v" THEN GO SUB 630
210 IF l$="c" THEN GO SUB 680
220 REM ** PRINTOUT **
230 LET count=0
240 IF d=5 THEN LET b=11
250 IF d=5 THEN LET d=1
260 LET y=(CODE (l$)-97
270 LET x=15880+8*y
280 FOR j=x TO x+7
290 LET z=PEEK j
300 FOR n=7 TO 0 STEP -1
310 PRINT AT b+count,8*(d-1)+n;CHR$( ((z-2*INT (z/2))*111)+32)
320 LET z=INT (z/2)
330 NEXT n
340 LET count=count+1
350 NEXT j
360 LET d=d+1
370 NEXT k
380 PRINT AT 20,1; FLASH 1;"TIMING HAS STARTED"
390 PAUSE 1260
400 PRINT AT 20,1; FLASH 1;"TYPE S TO STOP ALARM"
410 BEEP 0.5,0: BEEP 0.5,2
420 IF INKEY$="s" THEN GO TO 440
430 GO TO 410
440 REM ** INPUT **
450 REM ** SCORES **
460 INPUT "PLAYER 1 SCORE PLEASE",s$1
470 INPUT "PLAYER 2 SCORE PLEASE",s$2
480 LET t1=t1+s$1
490 LET t2=t2+s$2
500 CLS
510 PRINT AT 0,1;"PLAYER 1 ";t1
520 PRINT AT 10,1;"PLAYER 2 ";t2
530 PRINT "TYPE C TO CONTINUE": PRINT "OR S TO END GAME"
540 IF INKEY$="c" THEN GO TO 580
550 IF INKEY$="s" THEN GO TO 580
560 IF INKEY$<>" " THEN GO TO 560
570 IF INKEY$="" THEN GO TO 540
580 CLS
590 NEXT i
600 IF t1>t2 THEN PRINT "PLAYER 1 WINS"
610 IF t1<t2 THEN PRINT "PLAYER 2 WINS"
620 STOP
630 REM VOWELS
640 LET v$="aeiou"
650 LET a=INT (1+RND*5)
660 LET l$=v$(a)
670 RETURN
680 REM CONSONANTS
690 LET c$="bcdfghjklmnpqrstvwxyz"
700 LET a=INT (1+RND*21)
710 LET l$=c$(a)
720 RETURN

```

CHARLES COWAN, who wrote Four in One — see March issue, page 166 — has sent in another game for two players which also fits on to a 16K Spectrum. This one is based on the popular television programme *Countdown*.

Each player is given eight random letters. The only choice allowed is whether each one shall be a vowel or a consonant. You then have 30 seconds to make a word from these random letters and scores according to the length of the word. Instructions are included in the program.

Solver

K D Drew of Leiman, West Germany has a program for solving simultaneous equations. Though written for the ZX-81 it could be run unchanged on a Spectrum; in fact, with a few modifications, it could run on any computer.

The program solves simultaneous equations with up to 35 unknown variables. The number of equations must, of course, be equal to the number of unknowns. Do not include pairs of linearly dependent

equations such as

$$3x_1 + 2x_2 = 24$$

$$6x_1 + 4x_2 = 48$$

You can write the equations in the form

$$b_{1,1}x_1 + b_{1,2}x_2 + \dots + b_{1,k}x_k = y$$

$$b_{2,1}x_1 + b_{2,2}x_2 + \dots + b_{2,k}x_k = y$$

....

$$b_{k,1}x_1 + b_{k,2}x_2 + \dots + b_{k,k}x_k = y$$

where k is the number of variables to be found. The parameters b and y must be known but may have the value 0.

In lines 300 to 390 the input algorithm
(continued on next page)

Solver.

```

100 REM *****
110 REM **** SIMULTANEOUS ****
115 REM **** EQUATIONS ****
120 REM *****
130 REM ***** C 1980 *****
140 REM ***** K D DREW *****
150 REM *****
200 REM ***** INPUT *****
210 PRINT "NUMBER OF UNKNOWN = "
220 INPUT K
230 PRINT K
240 PRINT
250 PRINT "SOLUTION WITH ";K;" "
260 PRINT "EQUATIONS"

```

(listing continued on next page)

(listing continued from previous page)

```

300 DIM R(K)
310 DIM S(K,K+1)
320 DIM T(K,K)
400 FOR A=1 TO K
410 LET T(A,A)=1
420 FOR B=1 TO K+1
430 PRINT "EQU ";A;
440 IF B<=K THEN PRINT ",PARAM
B";B; " = ";
450 IF B=K+1 THEN PRINT ", Y
= "
460 INPUT S(A,B)
470 PRINT S(A,B)
480 NEXT B
490 NEXT A
495 GOSUB 1000
500 REM ***** COMPUTATION *****
510 FOR A=1 TO K
520 IF S(A,A)=0 THEN GOSUB 2000
525 LET Q=S(A,A)
530 FOR B=1 TO K
540 LET S(A,B)=S(A,B)/Q
550 LET T(A,B)=T(A,B)/Q
560 NEXT B
570 FOR C=1 TO K
580 IF C=A THEN GOTO 630
585 LET Q=S(C,A)
590 FOR D=1 TO K
600 LET S(C,D)=S(C,D)-(Q*S(A,D)
)
610 LET T(C,D)=T(C,D)-(Q*T(A,D)
)
620 NEXT D
630 NEXT C
640 NEXT A
650 FOR A=1 TO K
660 FOR B=1 TO K
670 LET R(A)=R(A)+(S(B,K+1)*T(A
B))
680 NEXT B
690 NEXT A
900 REM ***** RESULTS *****
905 PRINT "SOLUTIONS FOR X-VALU
ES : "
908 PRINT
910 FOR A=1 TO K
920 PRINT " X";A;" = ";R(A)
930 NEXT A
940 STOP

```

```

1000 REM *** THE EQUATIONS ***
1002 CLS
1008 PRINT "EQUATIONS : "
1009 PRINT
1010 FOR A=1 TO K
1020 FOR B=1 TO K+1
1030 IF B<=K THEN PRINT S(A,B);
*X";B; "
1035 IF B<K THEN PRINT "+ ";
1040 IF B=K+1 THEN PRINT " = ";S
(A,B)
1050 NEXT B
1055 PRINT
1060 NEXT A
1090 RETURN
2000 REM * MATRIX INVERTIBLE ? *
2010 IF A=K THEN GOTO 2100
2020 FOR P=A+1 TO K
2030 IF P=A THEN GOTO 2050
2040 IF S(P,A)<>0 THEN GOTO 2200
2050 NEXT P
2100 PRINT "NO UNIQUE SOLUTION"
2110 STOP
2200 FOR B=1 TO K
2210 LET M=S(P,B)
2220 LET N=T(P,B)
2230 LET S(P,B)=S(A,B)
2240 LET T(P,B)=T(A,B)
2250 LET S(A,B)=M
2260 LET T(A,B)=N
2270 NEXT B
2300 RETURN

```

Sample run.

```

EQUATIONS
3*X1 + 6*X2 + 8*X3 = 19
5*X1 + 4*X2 + 12*X3 = 51
0*X1 + 8*X2 + -6*X3 = -38
SOLUTIONS FOR X-VALUES
X1= 5
X2= -2.5
X3= 3

```

(continued from previous page)

builds up two matrices. One contains the parameters plus the vector y in the k+1st column; the other is the unit matrix. In lines 500 to 690 the data matrix is transformed into a unit matrix. The same operations are applied simultaneously to the unit matrix which is thus transformed into the inverse matrix B₁. Lines 650 to 690 give the vector for the solutions, as

$$x = B_1 y$$

In lines 900 to 970 LPrint or similar statements may be added if you wish to obtain a hard copy, otherwise the results are displayed on the screen. Lines 1000 to 1090 display the equations. Lines 2000 to

2300 check if the matrix can be inverted. If not, an error message is displayed.

Eyesight saver

Anyone who has copied programs from this or any other page will know it plays havoc with the eyesight if the coding is packed to maximum density. This is fine for memory economy but terrible for reading and copying. But hope is at hand. CP Marriner of Grimsby has sent in a small routine which will shake up a program of multi-statement lines so that each statement is on a new line. The routine itself is given

in its formatted and unformatted state.

The Spectrum stores programs in memory from location 23755. Each line of the program is then stored with two bytes for the line number, and two bytes holding the length of the text, the text of the line and an end-of-line marker CHR\$(13).

The routine lists any Basic program with the following changes. Every time a colon or the keyword Then is found a new line is started with correct indentation to match the preceding line.

In practice the routine is merged with the program and suitably isolated. To print the formatted listing enter Goto 9000 or its equivalent if you have renumbered. P

Eyesight saver.

```

9000 REM Format listing
9005 OPEN #2,"p": LET dsp=0: REM
printer,spacing
9010 LET n=23755
9015 IF dsp=1 THEN PRINT
9020 PRINT ": PRINT 256*PEEK N+P
EEK (N+1);
9025 LET space=LEN STR$ (256*PEE
K n+PEEK (n+1))+1
9030 IF 256*PEEK n+PEEK (n+1)>=9
100 THEN OPEN #2,"s": PRINT " O.
K.": STOP
9035 FOR I=n+4 TO n+3+PEEK (n+2)
+256*PEEK (n+3)
9040 IF PEEK i=58 THEN PRINT " : "
;TAB space;: GO TO 9060
9045 IF PEEK i>=32 THEN PRINT C
HR$ PEEK i;
9050 IF PEEK i=14 THEN LET i=i+
5
9055 IF PEEK i=203 THEN PRINT 'T
AB space;
9060 NEXT i
9065 LET n=(n+3+PEEK (n+2)+256*P
EEK (n+3)+1)
9070 GO TO 9015

```

Tangle with tanks

THIS IS A GAME written in Basic 5.0 for the RML 380Z by Mark Callaway of Alnwick in Northumberland. High-resolution graphics are not required. *Practical Computing* published his version for the

BBC Micro in the February 1983 issue.

The game is for two players and is very fast. Each player controls a tank, and the winner is the one who can keep going the longest without hitting anything.

The players have a choice of steering method and can select the size of playing field: smaller fields make the game more difficult. You can also ask the computer to place extra obstacles on the field.

```
10 REM*****
20 REM***      ***
30 REM*** Super Tangle ***
40 REM*** Copyright ***
50 REM*** Mark Callaway***
60 REM*** 28th December***
70 REM***      ***
80 REM*****
90 TEXT
100 DATA 1,1,0,0,-1,-1,0
110 DIM D(4,2)
120 MS=0:US=0
130 FOR T=0 TO 3:FOR X=0 TO 1:READ D(T,X):NEXT X:NEXT T
140 PRINT "Welcome to Super Tangle"
150 PRINT:PRINT "The object of the game is to steer your tank and a
void hitting any walls."
160 PRINT
170 INPUT "What is player 1's name? ";M$
180 INPUT "What is player 2's name? ";U$
190 PRINT:INPUT "Do you want to use (1) relative or      (2) absolu
te steering ";FLAG
200 IF FLAG=1 THEN 230
210 IF FLAG=2 THEN 300
220 PRINT "ERROR - enter 1 or 2":GOTO 190
230 PRINT:PRINT M$;" use these keys:"
240 PRINT " 'A' turn anti-clockwise"
250 PRINT " 'D' turn clockwise"
260 PRINT:PRINT U$;" use these keys:"
270 PRINT " 'J' turn anti-clockwise"
280 PRINT " 'L' turn clockwise"
290 GOTO 400
300 PRINT:PRINT M$;" use these keys:"
310 PRINT " 'W' up"
320 PRINT " 'A' left"
330 PRINT " 'D' right"
340 PRINT " 'X' down"
350 PRINT:PRINT U$;" use these keys:"
360 PRINT " 'I' up"
370 PRINT " 'J' left"
380 PRINT " 'L' right"
390 PRINT " ',' down"
400 PRINT:INPUT "How many games do you want to play ";GAMES
410 INPUT "How wide is your screen (40/80) ";C

420 REM Try smaller values than 40 or 80 if you want a smaller
430 REM playing field and a more difficult game.
440 C=C*2-1
450 INPUT "Do you want some extra walls in the      playing field (Y
/N) ";X$
460 GRAPH

470 REM draw border around screen
480 PLOT 0,0,2
```

(continued on next page)

(continued from previous page)

```

490 LINE0,59,2
500 LINEC,59,2
510 LINEC,0,2
520 LINE0,0,2
530 IFLEFT$(X$,1)="N"ORLEFT$(X$,1)="n"THEN590

```

```

540 REM draw extra walls on screen
550 PLOT20,19,2:LINEC-20,19,2

```

```

560 PLOT20,39,2:LINEC-20,39,2
570 PLOT0,29,2:LINE20,29,2
580 PLOT0,29,2:LINEC-20,29,2
590 MX=5:MY=5:MD=1
600 UX=C-5:UY=54:UD=3
610 A$=GET$(0):IFA$=""THEN790
620 IFFLAG=1THEN740

```

```

630 REM Absolute steering
640 IFA$="W"ORA$="w"THENMD=0:GOTO720
650 IFA$="D"ORA$="d"THENMD=1:GOTO720
660 IFA$="X"ORA$="x"THENMD=2:GOTO720
670 IFA$="A"ORA$="a"THENMD=3:GOTO720
680 IFA$="I"ORA$="i"THENUD=0:GOTO720
690 IFA$="L"ORA$="l"THENUD=1:GOTO720
700 IFA$=","ORA$=">"THENUD=2:GOTO720
710 IFA$="j"ORA$="J"THENUD=3:GOTO720
720 GOTO790

```

```

730 REM Relative Steering
740 IFA$="A"ORA$="a"THENMD=MD-1:IFMD=-1THENMD=3
750 IFA$="D"ORA$="d"THENMD=MD+1:IFMD=4THENMD=0
760 IFA$="J"ORA$="j"THENUD=UD-1:IFUD=-1THENUD=3
770 IFA$="l"ORA$="L"THENUD=UD+1:IFUD=4THENUD=0

```

```

780 REM Test for collisions
790 IFPOINT(MX+D(MD,0),MY+D(MD,1))<>0THEN850
800 IFPOINT(UX+D(UD,0),UY+D(UD,1))<>0THEN850

```

```

810 REM Move players
820 MX=MX+D(MD,0):MY=MY+D(MD,1):UX=UX+D(UD,0):UY=UY+D(UD,1)
830 IF MX=UX AND MY=UY THEN?"crunch":GOTO910
840 PLOTMX,MY,2:PLOTUX,UY,2:GOTO610

```

```

850 REM Crash
860 MX=MX+D(MD,0):MY=MY+D(MD,1)
870 UX=UX+D(UD,0):UY=UY+D(UD,1)
880 IFPOINT(MX,MY)<>0ANDPOINT(UX,UY)<>0THENPRINT"crunch":GOTO910
890 IFPOINT(MX,MY)<>0THENPRINTM$;" crashed":US=US+1:GOTO910
900 MS=MS+1:PRINTU$;" crashed"
910 PRINTM$;" has ";MS;" pts."
920 PRINTU$;" has ";US;" pts."
930 A$=GET$(0)
940 GA=GA-1:IFGA<>0THEN460
950 RUN

```



R ENGLISH has sent in a program that designs perfect mazes. It is possible to reach any location in the maze from any other location by one, and only one, route.

The size of the maze is limited only by the available memory and the amount of time the operator is prepared to wait. It takes a long time to draw the maze. In this case, the maze is 25 cells by 15.

The A(375,1) array acts as a stack, storing locations that have been used. The B(25,15) array holds the data on the exits of each location in the maze. The D(3) array holds the available exits from a location being considered by the algorithm.

The algorithm works by starting at location 1,1 and picking a random direction from the ones available. If the direction chosen would join up with a location which has already been visited, or would be outside the maze, it is removed from the available directions and another one is picked.

If it is possible to move in the chosen direction the co-ordinates are changed correspondingly, the new location is placed on the stack, the doors of the cells are recorded by setting the appropriate bits in the B() array, and bit 8 is set, meaning that the location has been visited. The wall of the cell on the display is also removed. Line 110 does this for the horizontal direction and line 120 for the vertical.

If you cannot move in any direction from a particular location, that location is removed from the stack and a random pair of co-ordinates is selected from it. These co-ordinates are then swapped with the ones on the top of the stack so that there are no exits and the location which has been replaced is removed from the stack. When the stack pointer reaches zero there are no available exits from any location, so the maze is finished.

Memory map

Although Tandy provides a memory map for the Model I in the level II manual, it is not very detailed. There are a number of reserved areas marked on the memory map and Peeks and Pokes to these areas

Memory map address table.

```
14312 PRINTER CHECK. 63=OK:233 = CHECK
PAPER SUPPLY AND PRINTER SWITCH: 255=
PRINTER POWER OFF
15360 START OF VIDEO SCREEN DISPLAY
16383 END OF VIDEO SCREEN DISPLAY
16393 165=BREAK KEY DISABLED, 233 = BREAK
ENABLED (NOT FOR DISC OP. SYSTEMS)
16401 1= ENABLE KEYBOARD
16405 2= DISABLE KEYBOARD
16413 0 = DISABLE SCREEN, 7 = ENABLE
SCREEN
16424 PEEK SHOWS NUMBER OF LINES PER PAGE
+1. CAN BE POKED TO MODIFY
16425 COUNTER FOR NUMBER OF LINES
LPRINTED
16448-16454 SEE TRSDOS MANUAL ON CLOCK
16526 LSB OF ADDRESS OF USR ROUTINES
16527 MSB "
16546 LSB OF CURRENT LINE NUMBER
16547 MSB "
16863 LIST FUNCTION DISABLE:
POKE 16863,195 & POKE 16864,114 & POKE
16865,0 WILL DISABLE LIST FUNCTION
POKE 16863,201 WILL ENABLE LIST FUNCTION
16633 LSB OF ADDRESS OF END OF PROGRAM
16634 MSB OF " " " "
```

Perfect mazes

```
10 REM SET UP ARRAYS ETC
20 CLS:DEFINT A-Z:DIM
A(375,1),B(25,15),D(3)
30 REM DRAW GRID
40 FOR A= 0 TO 124:FOR B= 0 TO 47 STEP
3:SET(A,B):NEXT B,A
50 FOR B=0 TO 45:FOR A=0 TO 127 STEP
5:SET(A,B):NEXT A,B
60 REM DRAW MAZE
70 X=1:Y=1:SP=0
80
SP=SP+1:A(SP,0)=X:A(SP,1)=Y:B(X,Y)=B(X,
Y) OR 128
90 FOR A=1 TO 4:D(A-1)=A:NEXT A:ND=4
100 D=AND(ND)-1:C=D(D)
110 IFC=1ORC=2THEN IF C=1 AND X=25 OR
C=2 AND X=1 THEN 150 ELSE IF
B(X-2*C+3,Y) AND 128 =128 THEN 150
ELSE B(X,Y)=B(X,Y) OR 2(C-1):
B(X-2*C+3,Y)=B(X-2*C+3,Y) OR
2(C-2):XC=(1-C*X)*5:YC=46-3*Y:RESET
```

```
XC,YC):RESET(XC,YC+1):X=X+(1.5-C)*2
120
IFC=3ORC=4THENIFC=3ANDY=15ORC=4ANDY=1TH
EN150ELSEIFB(X,Y-2*C+7)AND128=128THEN15
0ELSEB(X,Y)=B(X,Y)OR 2(C-1):B(X,Y-2*C
+7)=B(X,Y-2*C+7)OR 2(C-1):XC=(X-1)*5+
1:YC=(12-Y+C)*3:RESET(XC,YC):RESET(XC+1
,YC):RESET(XC+2,YC):RESET(XC+3,YC):Y=Y+
(3.5-C)*2
130 GOTO 80
140 REM DECREMENT STACK
150 ND=ND-1:D(D)=D(ND):IF ND()=0 THEN
100
160 REM PICK NEW LOCATION AND PUT ON
TOP OF STACK
170 SP=SP-1:IF SP()=0THEN
R=AND(SP):X=A(R,0):Y=A(R,1):A(R,0)=A(SP
,0):A(R,1)=A(SP,1):A(SP,0)=X:A(SP,1)=Y:
GOTO 90
180 GOTO 180
```

will not be used in Basic programs. But there are many locations between the top of ROM at 12288 and the beginning of the program area which can vary according to whether you are using level II, TRS-DOS or other DOSs.

The address of the beginning of a program is held in locations 16548 and 16549 and X is equal to this address in

X = PEEK(16548) + PEEK(16549) * 256

The table shows a number of addresses, in which the values are those to be Poked into the address or to be Poked from the address.

Genie tips

A J Brier of Lytham St. Annes, Lancashire has been programming on the Genie for three years and has submitted the following tips. The first one I have published before but as it can be very useful and some readers may have missed it, I will repeat the method of changing Print to LPrint in a program. It is very simple and consists of two lines as in listing 1.

This will be for a 16K tape machine. If you are using disc and/or a 48K machine the range of X will be from start address of the program to the top of your available memory.

Mr Brier's second listing is to find the token of any reserved word. Again, the range of X will depend on your system.

There is a handy interrupt vector which can be changed to alter the main program flow of the ROM and patch it to your own machine-code program. It can be used to run constantly your own machine-code programs while in Basic mode, and could prove extremely useful for flashing cursor routines which need to be constantly running while in Basic.

The address of this useful interrupt is 4016 hex. To utilise this changeable address — changeable because it is located in cold start RAM — you might have this at the beginning of your assembly program

10 INIT LD HL, PROGST

which loads HL with address of your

Genie tips. Listing 1.

```
10 FOR X=17129 TO 32000:
IF PEEK(X)=178 THEN POKE X,175
20 NEXT
```

Listing 2.

```
20 REM *PRINT COMMAND HERE AFTER
**
30 FOR X=17129 TO 20000: IF
PEEK(X)=43 THEN 40 ELSE NEXT X
40 PRINT PEEK(X+1)"IS THE TOKEN
VALUE OF YOUR RESERVED WORD":END
```

program Progst,

20 LD(4016H), HL

load interrupt address with pos, of Progst,

30 JP 1ALH

to return to normal Basic running,

40 PROGST

for the start of your program, and

1000 END JP 03E3H

which should always be put at the end of your program after whatever operations you wished to have been carried out in your program have been done. This Jump is what should have been at Address 4016H.

Line 1000 continues the main ROM program flow. After changing the address at 4016H to that of your program, the computer will always jump to your program unless the machine is turned off or reset. A reset causes the computer to rewrite the cold start ROM and therefore change the address back to its original state.

Sound advice

Norman Bailey of Bracebridge Heath in Lincolnshire has sent some information on obtaining sound with the Model I or III. You need an amplifier and a speaker attached to the Aux plug of the cassette lead.

The Archer 200mW amplifier/speaker, Cat No. 277-1008B, costs £7.99 at Tandy stores. You plug the Aux lead into it. You can then produce sound by addressing the cassette port 255. Apart from the TRS-80, the unit should work with any system which has an addressed cassette port. □

CAMEL PRODUCTS

firm up your software with an
EPROM PROGRAMMER

AT LAST! for the Spectrum user. Put your programs, utilities, Assemblers into EPROMS for instant load from the unique ROM-SP

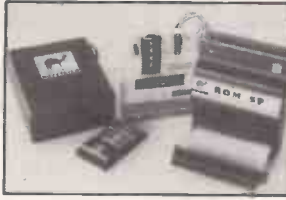

ROM-SP NEW for Spectrum
Ingenious unit for Spectrum, with 2X28 pin sockets and a Reset button allows up to 16K of Basic or M/C program to RUN or LOAD instantly from EPROMS. Cabled connector and full extender card. NOTE: Does not disable Sinclair ROM. £29.95

PROMER-SP NEW for Spectrum
A brand new Spectrum programmer for 2764/128. Zero insertion force socket & software on tape. Delivery Jan. 84. Order now at £29.95

PROMER 81-S NEW for Spectrum
The very popular PROMER-81 for the ZX81 has been adapted to the Spectrum and the price kept low. £22.95

ROM-81
Provides two 24 pin sockets for up to 8K of EPROM memory in the 8-16K area. Can use 2516/32 or 2716/32 £14.95

PROMER-81
At last! A low cost reliable programmer for 2516/32, 2716/32 EPROMS. Requires 4xPP3 batteries for a regulated 25 volts. Remarkably priced at £19.95

BLOPROM-81
A uniquely sophisticated EPROM PROGRAMMER

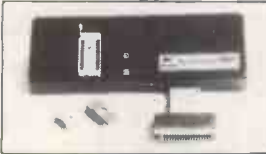

In use at various labs incl. Sinclair Eprom programmer for the 2516, 27XX single supply families, yes, even the 27128 from Intel. Check, Read, Program + Verify all or part of Eprom.

So immensely user friendly you'll hardly need the manual. Designed for the beginner but includes a single key entry route for the professional. Supplied as firmware, the m/c driver routine alone is worth more than the price of BLOPROM-81. No Personality Cards, or other additions, just a ZX81. Several inbuilt safety features. On-board Vpp generation. 28pin ZIF socket. Cabled connector and extender plug. ABS case. £79.95

STATUS	NO. OF SYSTEM	HEX
	EPROM TYPE	27128
	RAM START ADDR	4900
	EPROM ST. ADDR	9000
	JOB LENGTH	4000
	TASK	CHECK

WHICH TASK DO YOU WISH TO DO
W) CHECK THAT EPROM IS CLEAN
X) READ THE CONTENTS OF EPROM INTO RAM
Y) SLOW AN EPROM WITH DATA FROM RAM
Z) VERIFY THAT EPROM DATA IS THE SAME AS IN RAM
Q) TO QUIT
R) TO RESTART

FAST CODES AVAILABLE
D H PQR WXYZ

DREAM-81
Full 64K Rampack with link options to disable 0-8-16K. Plus a 28 pin EPROM socket for 2716, 2732/2764 and even the latest 27128 from Intel. Fast/slow Eprom option, professionally built and tested. In an ABS case with an LED indicator. £59.95

DHOBI 1 UV ERASER
Compact. Mains powered. Safe. Fully cased. Up to 3 EPROMS £18.95

DHOBI 2 With automatic timer. £22.95

MEMIC-81
A 4K CMOS RAM and lithium battery unit. Easy SAVEing, 10yr storage and instant retrieval of programs. Resides in 8-12K or 12-16K of ZX81. £29.95

CRAMIC-81
Ingenious hardware/software allows this 16K CMOS RAM with lithium battery to Co-exist in same memory area as ordinary RAM. ZX81 can multitask on two completely independent programs. £79.95

PRINTER/MONITOR ACCESSORIES



MSB Monitor Stand for BBC micro. Sits over the Beeb 17"x12"x3.75" P&P £3.50 £19.95

PSS Standard printer stands for OKI. Epson etc. 15"x12"x4.5". P+P £3.50 £16.95

PSL Large model 17"x14.5"x3.75" P&P £3.50 £19.95

PSC-3 for Epson MX-100 etc. 21"x14"x3.75". P&P £3.50 £22.95

CUSTOM PRINTER STANDS for larger printers P.O.A.

POT Printer Output Tray for 11" fanfold paper P&P £3.50 £16.95



UK. VAT extra. No VAT on exports P+P UK Free Europe +5% — Overseas +10% TLX 81574 CML

Cambridge Microelectronics Ltd. One Milton Rd, Cambridge CB4 1UY

tel (0223) 314 814

This man can use...

**46 Microcomputers 6 Word Processors
16 Printers 2 Mini Computers**



...all without leaving his seat!

Clearway

is a low cost Networking device allowing ALL minis, micros, printers, mainframes etc. to communicate with each other.



- From £150 per connection (node)
- No controller needed.
- Easy installation
- Connects any hardware device through an RS232 interface
- Up to 99 nodes on the same ring
- File sharing software available
- Enables printer sharing
- Has special hunting feature
- Other models available
- Over 3000 nodes currently installed
- Manufactured and supported in UK

Mail the coupon now for full information

Real Time Developments Limited, Lynchford House, Lynchford Lane, Farnborough, Hampshire GU14 6JA Telephone: Farnborough (0252) 546213 Telex: 858893 Fietel G

I am interested in Clearway – the low cost Networking device, please send me details

Name

Position

Address

.....

.....

Telephone

Send to: Real Time Developments
Lynchford House, Lynchford Lane, Farnborough, Hampshire GU14 6JA
Telephone: Farnborough (0252) 546213 Telex: 858893 Fietel G

● Circle No. 185

● Circle No. 186

Bertie the Beetle

THIS GAME from William Prew of Putney, London requires dexterity to play. You play the hero, Bertie the Beetle, and assist Suzy the Snail to get back her children, which have been taken away.

Pressing Z moves you to the left, X moves you right, / moves you down and :

moves you up. The high score is 250 and you have a short time in which to move around the screen collecting Suzy's children while avoiding hedges and walls.

Your aim is to collect as many of Suzy's children from as many rooms as possible. To exit from a room you need to reach the

top right-hand corner of the screen and touch a yellow pad. Attempting to leave a room without all the children in it results in death.

The program includes an advanced sound routine which produces very loud sound at the end of the game.

```

10 REM Bertie The Beetle
20 REM By William Prew
30 REM (c) Sept. 1983
40 MODE1:PROCinst
50 MODE1:PROCinit
90 Live=3:score=0:hiX=250
100 score=0:screenX=1
110 VDU23,10,32;0;0;0;12
120 PROCwall:PROCplot
130 PROCsnails:PROCsound(6)
140 PROCinit
150 REPEAT
160 VDU17,1,31,xX,yY,225
170 PROCdisplay
180 PROCwait(speed)
190 IF INKEY(-98)=-1 THEN AS="LEFT"
200 IF INKEY(-67)=-1 THEN AS="RIGHT"
210 IF INKEY(-73)=-1 THEN AS="UP"
220 IF INKEY(-105)=-1 THEN AS="DOWN"
230 VDU17,2,31,xX,yY,227
240 IF AS="LEFT" THEN xX=xX-1
250 IF AS="RIGHT" THEN xX=xX+1
260 IF AS="UP" THEN yY=yY-1
270 IF AS="DOWN" THEN yY=yY+1
280 IF POINT(xX*32+16,(31-yY)*32+16)=2
AND score<25*screenX THEN PROCend
290 VDU26
300 PX=POINT(xX*32+16,(31-yY)*32+16)
310 IF PX<3 THEN PROCfindout
320 Time=Time-1
330 IF Time<=0 THEN PROCend
340 UNTIL FALSE
350 *****
360 DEFPROCinit
370 AS="RIGHT":xX=3:yY=27:Time=500
380 ENVELOPE1,3,0,0,0,1,1,1,126,-4,0
,-4,126,90
390 ENVELOPE2,1,0,0,0,0,0,61,0,-10
,-10,60,0
400 ENVELOPE3,136,-1,-1,-1,30,2,2,-1
,0,0,-10,-10,60,60
410 ENVELOPE4,1,-8,0,1,5,2,40,61,-1
,-1,-4,126,126
420 VDU23,224,126,153,153,255,255,153,
153,126
430 VDU23,225,195,129,66,60,90,126,60,
195
440 VDU23,226,0,170,124,56,146,214,124
,56
450 VDU23,227,800,800,800,800,800,800,
800,800
460 VDU23,228,255,231,255,207,255,231,
255,207
470 VDU23,229,5,34,119,255,255,254,254
,254
480 VDU23,230,129,66,60,60,36,90,66,12
9
490 VDU23,235,0,20,62,127,127,62,28,8
500 VDU23,236,0,5,34,119,255,255,254,2
54

```

```

510 ENDPROC
530 DEFPROCwait(T)
550 FOR DX=1 TO T
560 NEXT DX
570 ENDPROC
590 DEFPROCwall
595 VDU17,131,17,1,12,31,15,0
600 VDU17,1,31,2,3:PRINT"Time ";TAB(2,
4);"Score ";
610 PRINTTAB(15,3);"Lives ";Live;TAB(3
0,4);"Room ";screenX
620 PRINTTAB(15,4);"Hi-Score "
630 VDU5:GCOLOR,0:MOVE400,980:PRINT"Ber
tie The Beetle."
640 GCOLOR,2:MOVE395,984:PRINT"Bertie T
he Beetle.":VDU4
650 FOR wall=0 TO 39
660 COLOUR0
670 PRINTTAB(wall,5);CHR$(224);TAB(wal
l,30);CHR$(224)
690 NEXT wall
700 FOR wall=5 TO 28
710 PRINTTAB(0,wall);CHR$(224);TAB(39,
wall);CHR$(224)
730 NEXT wall
740 COLOUR2
750 PRINTTAB(37,4);CHR$(224);TAB(38,4)
;CHR$(224)
760 ENDPROC
780 DEFPROCplot:COLOUR0
790 FOR obst=1 TO screenX*10
800 VDU31,RND(29)+6,RND(21)+6,227,228,
228,228
810 VDU31,RND(28)+6,RND(20)+6,226
820 PROCwait(100)
830 NEXT obst
840 ENDPROC
860 DEFPROCsnails
870 FOR snails=1 TO 5
880 VDU17,1,31,RND(34)+1,RND(20)+6,229
890 SOUND3,2,54,1:PROCwait(700):NEXT s
nails:PROCwait(800)
900 PROCwait(800)
910 ENDPROC
930 DEFPROCfindout
940 IF PX=0 THEN PROCend
950 IF PX=1 score=score+5:PROCsound(1)
960 IF PX=2 PROCnextsheet
970 IF PX=2 AND score<=25 THEN PROCend
980 ENDPROC
1000 DEFPROCdisplay:COLOUR2
1010 IF score>hiX THEN hiX=score
1020 PRINTTAB(8,2);INT(Time);TAB(8,3);I
NT(score);TAB(25,3);INT(hiX);
1030 ENDPROC
1050 DEFPROCend
1060 VDU17,1,31,xX,yY,230:PROCsound(5):
PROCwait(3000)
1070 Live=Live-1: IF Live=>=0 THEN 110:E
NDPROC
1080 score=0:*FX15,0

```

```

1090 VDU17,1,30
1100 RESTORE 1120:VDU4:COLOUR2:FOR LX=1
TO 9:READ MES$:PRINTTAB(14+LX,5);MESS:T
IME=0:REPEAT UNTIL TIME>50:NEXT LX:COLO
UR2:PRINTTAB(14,7)"Hard Luck."
1110 RESTORE 1130:FOR IX=0 TO 17:READ M
1,M2:SOUND1,-15,M1,M2:SOUND2,-15,M1+48,M
2:SOUND3,-15,M1+96,M2:SOUND&1001,0,0:N
EXT IX
1120 DATAG,A,M,E," ",0,V,E,R
1130 DATAB1,4,77,4,81,4,61,4,81,4,77,4,
81,4,61,4,33,4,33,4,41,4,41,4,49,8,49,4,
49,4,41,4,41,4,33,16
1140 PRINTTAB(3,7)"Press SPACEBAR to pl
ay again."
1150 REPEAT UNTIL GET=ASC " ":RUN:CLS
1170 DEFPROCnextsheet
1180 VDU17,1,31,xX,yY,225,17,0,31,11,14
1190 PRINT"Snail Hunt ";screenX;" Compl
eted."
1200 PROCwait(5000):screenX=screenX+1:C
LS:GOTO 120
1210 ENDPROC
1230 DEFPROCinst
1240 COLOUR2:PRINTTAB(13,1)"Bertie The
Beetle."
1250 PRINTTAB(10,3)"By William Prew ":C
OLOUR1
1260 PRINT"" Bertie the beetle is in
Love with"
1270 PRINT" Suzy the snail.Suzy has b
een"
1280 PRINT" robbed of all her children
so"
1290 PRINT" called Bertie who was just
too"
1300 PRINT" happy to assist."
1310 COLOUR2:PRINT"" ENTER SPEED (1-
5) ??:REPEAT IX=INSTR("12345",GETS)
1320 UNTIL IX:PRINT IX:speed=(IX)*10
1390 COLOUR2:PRINT"" Press the SPA
CE BAR to continue.":REPEAT UNTIL GET=A
SC " ":CLS
1520 ENDPROC
1540 DEFPROCsound(N%)
1550 piX=0:durX=2
1560 ON NX GOTO 1570,1580,1590,1600,162
0,1630,1640
1570 SOUND17,4,100+4*piX,durX:ENDPROC
1580 SOUND1,2,150+8*piX,2:ENDPROC
1590 SOUND17,3,150+4*piX,2:ENDPROC
1600 qx=0:rX=0:FOR nX=0 TO 60 STEP 4
1610 pX=48+(nX*(nX*MOD12=8))MOD16*4:SOUN
D1,1,pX,5:SOUND2,1,qX,5:SOUND3,1,rX,5:r
X=qX:qX=pX:NEXT nX:ENDPROC
1620 SOUND0,1,4,20:FOR nX=1 TO 6:RX=95
EOR ?RX:NOW=TIME:REPEAT UNTIL TIME>10
1630 FOR ChannelX=17 TO 19:SOUNDChanne
LX,-8,0,20:NEXT ChannelX:ENDPROC
>

```

Moving pyramid

This is a short graphics program from Simon Pithers of Ongar, Essex. Procintro, as its title suggests, is the introduction. Procsetvar sets up all the needed variables for the program. Procmainprog draws and undraws the pyramid.

Variables A% and C% are the vertical co-ordinates of the pyramid B% and D% are the horizontal co-ordinates of the pyramid, X% and Y% are the vertical speed co-ordinates and X1% and Y1% are the horizontal speed co-ordinates.

Moving pyramid.

```

10 MODE7:PROCINTRO
20 MODE2:PROCSET_VAR:PROCMAIN_PROG
30 END
40 DEF PROCSET VAR
50 AX=RND(200)*500:BX=RND(200)*500
60 CX=RND(200)*500:DX=RND(200)*500
70 YX=RND(20):Y1X=RND(20)
80 Y1X=RND(20):X1X=RND(20)
90 ENDPROC
100 DEF PROCMAIN_PROG
110 VDU8202;0;0;0;
120 PRINTTAB(2,30);"3D MOVING PYRAMID"
130 REPEAT
140 GCOLOR,0
150 MOVEAX,BX:DRAWXCX,DX:DRAWBX,CX:DRAW
AX,BX
160 DRAWX,DX:MOVEBX,CX:DRAWDX,DX

```

```

170 IF AX>1000ORAX<200THENX=X-1
180 IF CX>1000ORCX<200THENX1=X1-1
190 IF BX>900ORBX<130THENY=Y-1
200 IF DX>900ORDX<130THENY1=Y1-1
210 AX=AX+XX:BX=BX+YX:CX=CX+X1X:DX=DX+
Y1X
220 GCOLOR,2
230 MOVEAX,BX:DRAWXCX,DX:DRAWBX,CX:DRAW
AX,BX
240 GCOLOR,4:DRAWX,DX:DRAWXCX,DX:MOVEBX
,CX:DRAWDX,DX
250 UNTIL FALSE
260 DEFPROCINTRO
270 FORIX=8TO9:PRINTTAB(8,IX);CHR$(141);
"3D MOVING PYRAMID":NEXT
280 PRINTTAB(10,11);"BY Simon C. Pithe
rs."
290 Q=INKEY 300
300 ENDPROC
>

```

Micro Computer Disks Ltd

Computer supplies for the end-user

LOWEST PRICES FOR HIGHEST QUALITY PRODUCTS

MAXELL FLOPPY DISKS
DYSAN FLOPPY DISKS
MEMOREX FLOPPY DISKS

prices from **£2.09** per disk
 prices from **£1.89** per disk
 prices from **£2.05** per disk

Ribbons (over 50 varieties in stock)
 Multistrike High Capacity Ribbons **£1.95!!**
 Diablo/Qume Daisywheels **only £3.95 each!!**

NO MIDDLE MEN! NO FRILLS! STRAIGHT FROM THE WAREHOUSE!

0990 23002/3

M.C.D. LTD WILBURN HOUSE, LONDON ROAD, SUNNINGDALE, BERKSHIRE SL5 0ER

● Circle No. 187

TOP SAVINGS

★ ★ PRINTERS ★ ★

		PRICE EX VAT
HR1	BROTHER	£449.00
HR15		£349.00
HR25		£549.00
EP22		£130.00
EP44		£182.00
PJ1080A 40cps	CANON	£369.00
PW1080A 160cps		£279.00
PW1156A 160cps		£339.00
630 API SHEET FEEDER	DIABLO	£1325.00 £490.00
RX 80T	EPSON	£215.00
RX 80F/T		£242.00
FX 80		£329.00
MX 100F/T III		£375.00
FX 100F/T		£430.00
MT 80	MANNESMANN TALLY	£199.00
MT160		£419.25
MT180		£600.00
PIXI PLOTTER		£505.00
2010 20cps	NEC	£645.00
3510 35cps		£1149.00
7710 55cps		£1499.00
OKI 80A	OKI MICROLINE	£180.00
OKI 82A		£269.00
OKI 83A		£420.00
OKI 84A(P)		£655.00
OKI 84A(S)		£730.00
OKI 92P		£379.00
OKI 93P		£499.00
OKI 92S		£450.00
OKI 93S		£575.00
OKI 2410P		£1595.00

		PRICE EX VAT
9/45 RO	QUME	£1595.00
9/55 RO		£1945.00
11/40 RO		£1195.00
11/55 RO		£1375.00
SHEET FEEDER		£490.00
RP1300S	RICOH	£915.00
RP1600S		£1190.00
RP1600S SHEET FEEDER		£459.00
RP1600S TRACTOR FLOWWRITER 1600		£138.00 £1249.00
GP100A	SEIKOSHA	£175.00
GP250X		£219.00
GP700A Colour		£349.00
GEMINI 10X	STAR	£199.00
GEMINI 15X		£279.00
DELTA 10		£305.00
DELTA 15	TEC	£399.00
1550 P	TEC	£475.00
STARWRITER F1040		£895.00
STARWRITER F1055		£1235.00
SHEET FEEDER		£459.00

PRINTERS - OTHER

ANADEX DP6500 500cps	£2019.00
DRE 8925 240cps	£1385.00
FUJITSU SP830	£1545.00
HERMES 612C 400cps	£1695.00
JUKI 6100	£345.00
OLIVETTI INK-JET JP101	£189.00
OLYMPIA ESW103	£825.00
SHINWA CP80	£185.00
SMITH CORONA TP1	£249.00

★★ MONITORS & VDU's ★★

	PRICE EX VAT
JVC 12in Hi-Res	£229.95
KAGA 12in Hi-Res	£215.00
NEC JB201ME	£185.00
SANYO 14in Colour Hi-Res	£435.00
SANYO 12in Hi-Res	£84.50
HAZELTINE ESPRIT VDU	£395.00
TELEVIDE 910 VDU	£489.00

★★ COMPUTERS ★★

	PRICE EX VAT
256K 0.315MB	£1275.00
256K 0.315MB MONITOR	£1440.00
256K 315Kx2	£1445.00
256K 315Kx2 MONITOR	£1575.00
128K 1.2MB	£1675.00
256K 2.4MB	£2165.00
256K 10MB	£2995.00
128K MEMORY EXPANSION	£222.00
256K MEMORY EXPANSION	£344.00
512K MEMORY EXPANSION	£589.00
EXTERNAL 10MB HARD DISK	£1375.00
COMMODORE 64	£156.51
COMMODORE DISK 1541	£165.21
COMMODORE C2N 1530 CASSETTE	£36.51
COMMODORE MPS801 PRINTER	£175.00
IBEK 64/Parallel INTERFACE	£59.50
COMMODORE 8096	£675.00
EXTERNAL 10MB HARD DISK QX10	£1375.00 £1600.00
KAYPRO II	£1195.00
KAYPRO 10MB	£2250.00
160KB 2x320KB Disk Drives	£1895.00
MBC 550	£650.00
MBC 555	£799.00
SPECTRUM 48K	£108.70

MAYFAIR MICROS

362 YORK ROAD LONDON SW18 1SP TEL: 01-870 3255

MAIL ORDER ENQUIRIES WELCOME

● Circle No. 188

A USEFUL facility provided by many computers is the ability to suspend display to the screen by pressing a key, and to restart it by pressing the key again. This is particularly useful when you are listing long programs.

I G Barnard from Camberley in Surrey has provided a machine-code routine which enables the otherwise unused Videotext key to be used for suspending and restarting display. Two listings are provided, a Basic program for loading the routine, and

Screen hold

an assembler listing. Once the Hold.Bas has been loaded and run it can be cleared with the New command and other programs may be loaded.

The Hold function is implemented by intercepting the operating-system routine which tests for a program break. Instead of

immediately testing for break, a check is first made at location 59 to see if bit 6 is set, since it indicates that a key has been pressed. If so location 61 is checked for the Videotext key co-ordinate. If this key has been pressed the program loops until the key is pressed again.

Basic loader.

```

10 REM HOLD.BAS/X07
20 REM (c) I.G.Barnard 1983
30 REM HEX MACHINE CODE LOADER
40 REM AND RELOCATOR.
50 REM LOADS HEX TO TOP.
60 REM LOADS PROGRAM HOLD.ASM/X07
70 HX$="0123456789ABCDEF"
80 READ L:RESERVE L
90 M=TOP
100 P=1:READ D$
110 IF LEN(D$)=0 THEN 190
120 IF P>LEN(D$) THEN 100
130 H$=MID$(D$,P,2)
140 P=P+2
150 H=(INSTR(HX$,LEFT$(H$,1))-1)*16+INST
R(HX$,RIGHT$(H$,1))-1
160 POKE M,H
170 M=M+1:GOTO 120
180 REM NUMBER OF RELOCATION ADDRESSES
190 READ R
200 IF R<=0 THEN STOP
210 READ BA:REM ORIGINAL BASE ADDRESS
220 FOR N=1 TO R
230 READ A:REM RELATIVE ADDRESS OF WORD
240 AA=TOP+A:REM ABSOLUTE ADDRESS OF WO
RD
250 RA=PEEK(AA)+256*PEEK(AA+1):REM RELO
CATE ADDRESS
260 NR=RA-BA+TOP:REM NEW RELOCATED ADDRE
SS
270 POKE AA,NR-256*INT(NR/256)
280 POKE AA+1,INT(NR/256)
290 NEXT N
300 CALL TOP:REM EXECUTE INSTALL ROUTIN
E
310 STOP
320 REM NUMBER OF MACHINE-CODE BYTES (DE
CIMAL)
330 DATA 107
340 REM HEX DATA STRINGS
350 DATA E52A210022287821
360 DATA 1C78222100211678
370 DATA 222900A7E1C93004
380 DATA E323E3C9D908E1E5
390 DATA 7ED9FE36280408C3
400 DATA CCA008F33A3C00CB
410 DATA 772004FBA718FOCB
420 DATA B7323C003A3D00FE
430 DATA 1920F0FB00F33A3C
440 DATA 00CB772800CBB732
450 DATA 3C003A3D00FE1928
460 DATA DAFB00F33A2300B7
470 DATA 20E13A3C00CB5728
480 DATA DA18CB
490 DATA ""
500 REM NUMBER OF ADDRESS TO RELOCATE (D
ECIMAL)
510 DATA 3
520 REM ORIGINAL BASE ADDRESS OF CODE (D
ECIMAL)
530 DATA 30720
540 REM LIST OF WORDS RELATIVE TO BASE W
HIGH MUST BE RELOCATED (DECIMAL)
550 DATA 5,8,14
560 END

```

Assembler listing.

```

2
3
4 ; (c) I.G.Barnard 1983
5 ; SCREEN HOLD ROUTINE
6 ; FOR THE NEWBRAIN
7 ;
8 BREAK: EQU 54 ;BREAK TEST ROUTINE
9 KBSTAT: EQU 3CH ;KB STATE LOCATION
10 KBDATA: EQU 3DH ;KB DATA LOCATION
11 BRKBUF: EQU 23H ;BREAK ENABLE LOCAT
12 HOLDKEY: EQU 19H ;COORD OF HOLD KEY
13 OLD32: EQU 41164 ;OLD RST 32 ADDRESS
14 ;
15 ; START SETS THE NEW JUMP
16 ; ADDRESSES AT 33 AND 41, AND
17 ; COPIES WHAT WAS AT 33 TO
18 ; RESET+1, WHICH IS THE JUMP
19 ; BACK TO THE ORIGINAL RST ROUTINE
20 ;
21 ; THIS RODGE IS NECESSARY
22 ; BECAUSE OF TH DIFFERENT
23 ; ROMS IN VARIOUS GENERATIONS
24 ; OF NEWBRAINS, AND ALLOWS
25 ; THIS CODE TO RUN ON ANY
26 ; AGE NEWBRAIN WITHOUT HAVING
27 ; TO REPLACE ALL THE CODE FOR
28 ; THE COMPLETE RST32 ROUTINE
29 ;

```

(continued on next page)

(continued from previous page)

```

30 7800 E5      START:      PUSH HL
31 7801 2A2100      LD      HL, (33)
32 7804 222878      LD      (RESET+1),HL
33 7807 211C78      LD      HL,RST32
34 780A 222100      LD      (33),HL
35 780D 211678      LD      HL,RST40
36 7810 222900      LD      (41),HL
37 7813 A7          AND     A                ;RESET CARRY
38 7814 E1          POP     HL                ;RESTORE REG
39 7815 C9          RET
40
41                ;
42                ; NEW RST 40 ROUTINE
43                ; RST 40 + 1 BYTE ROUTINE NUMBER
44                ; IS EQUIVALENT TO
45                ; 'CALL NC,ROUTINE' EXCEPT
46                ; IT CAN BE INTERCEPTED HERE
47 7816 3004      RST40:      JR      NC,RST32        ; J IF C CLEAR
48 7818 E3          EX      (SP),HL        ; ELSE
49 7819 23          INC     HL                ; STEP PAST DATA BYTE
50 781A E3          EX      (SP),HL        ; AND RETURN
51 781B C9          RET
52
53                ;
54                ; NEW RST 32 ROUTINE
55                ; RST 32 + 1 BYTE ROUTINE NUMBER
56                ; IS EQUIVALENT TO
57                ; 'CALL ROUTINE'.
58                ; IF THE RST32 IS NOT FOR
59                ; BREAK TEST, IT IS IGNORED
60                ; AND THE OLD ROUTINE ENTERED
61 781C D9          RST32:      EXX
62 781D 08          EX      AF,AF
63 781E E1          POP     HL
64 781F E5          PUSH    HL
65 7820 7E          LD      A,(HL)        ; GET ROUTINE NUMBER
66 7821 D9          EXX
67 7822 FE36      CP      BREAK        ; IS IT BREAK ?
68 7824 2804      JR      Z,BRK0        ; J IF SO
69 7826 08          EX      AF,AF        ; ELSE RESTORE REGS
70 7827 C3C0A0    RESET:      JP      OLD32        ; AND GOTO OLD RST32
71 782A 08          BRK0:      EX      AF,AF
72 782B F3          DI                ; NO INTERRUPTS
73 782C 3A3D00    LD      A,(KBSTAT)
74 782F CB77      BIT     6,A            ; DATA AVAILABLE ?
75 7831 2004      JR      NZ,BRK1        ; J IF SO
76 7833 FB          BRK2:      EI                ; ELSE GOTO BRKTST
77 7834 A7          AND     A                ; CLEAR ERROR FLAG
78 7835 18F0      JR      RESET
79 7837 CBB7      BRK1:      RES     6,A            ; DATA USED
80 7839 323C00    LD      (KBSTAT),A        ; STORE NEW STATE
81 783C 3A3D00    LD      A,(KBDATA)        ; GET KEY COORD
82 783F FE19      CP      HOLDKEY        ; IS IT HOLD KEY ?
83 7841 20F0      JR      NZ,BRK2        ; J IF NOT
84 7843 FB          BRK4:      EI                ; TEMP ENABLE INTERRUPTS
85 7844 00          NOP                ; HERE BECAUSE EI DOESN'T
86                ; ENABLE INTERRUPTS UNTIL ONE INSTRUCTION AFTER
87                ; EI INSTRUCTION
88 7845 F3          DI                ; NO MORE INTERRUPTS
89 7846 3A3C00    LD      A,(KBSTAT)        ; CHECK FOR KEY PRESSED
90 7849 CB77      BIT     6,A
91 784B 280C      JR      Z,BRK3        ; J IF NOT
92 784D CBB7      RES     6,A            ; DATA USED
93 784F 323C00    LD      (KBSTAT),A        ; STORE NEW STATE
94 7852 3A3D00    LD      A,(KBDATA)        ; GET KEY COORD
95 7855 FE19      CP      HOLDKEY        ; IS IT HOLD KEY ?
96 7857 28DA      JR      Z,BRK2        ; J IF SO, TO BRKTST
97 7859 FB          ; BRK3:      EI                ; TEMP ENABLE INTERRUPTS
98 785A 00          NOP
99 785B F3          DI                ; AND INT OFF AGAIN
100 785C 3A2300   LD      A,(BRKBUF)        ; BREAK ENABLED ?
101 785F B7          OR      A
102 7860 20E1      JR      NZ,BRK4        ; J IF NOT
103 7862 3A3C00   LD      A,(KBSTAT)
104 7865 CB57      BIT     2,A            ; BREAK DETECTED ?
105 7867 28DA      JR      Z,BRK4        ; J IF NOT
106 7869 18C8      JR      BRK2        ; ELSE GOTO RETURN
107                END

```

Noughts and crosses

WHEN I FIRST received this program from A Patel of Croydon, I thought it trivial. Having played the game with a three-year-old I have changed my mind. It provided

lots of fun and an introduction to pressing keys and getting results.

The chief attraction of this version is the clarity of the display, with the full high-

resolution screen used to great effect. The program umpires between the two players, and announces the result of each game in turn.

```

1  REM *** NOUGHTS AND CROSSES
   ***
2  REM *** COMPUTER : APPLE II
   ***
3  REM *** LANGUAGE : APPLESOFT
   ***
4  REM *** (C) A. PATEL
   ***
5  REM *** DATE : 14/09/83
   ***
10 TEXT : HOME :A = FRE (0): POKE
   216,0
15 HOME : PRINT "WANT INSTRUCTIO
   NS <Y/N> ? " ; GET A$
20 IF A$ = "Y" THEN GOSUB 4000:
   GOTO 120
25 IF A$ < > "N" THEN HOME : GOSUB
   50: GOTO 15
30 GOTO 120
49 REM *** ERROR TRAP ***
50 VTAB 24: HTAB 13: INVERSE : PRINT
   "INVALID ENTRY"; CHR$(7);:
   NORMAL : FOR P = 1 TO 500: NEXT
   : VTAB 23: CALL - 958: RETURN

120 HOME :X$ = "(X) ? ": FOR I =
   1 TO 2: PRINT "NAME PLAYER £
   "I" "X$;: INPUT " ";N$(I):X$ =
   "(O) ? ": PRINT : NEXT : GR
   : COLOR= 15: FOR J = 0 TO 39
   STEP 13: VLIN 0,39 AT J: NEXT

129 REM *** ASK FOR NAMES ***
160 HLIN 0,39 AT 13: HLIN 0,39 AT
   26
180 FOR I = 1 TO 9
200 J = J + 1: IF J > 2 THEN J =
   1
220 HOME : PRINT : PRINT "CHOOSE
   A BOX, "N$(J)",": PRINT "BE
   TWEEN 1 AND 9 ? " ; GET B$: IF
   B$ < "1" OR B$ > "9" THEN GOSUB
   50: GOTO 220
240 B = VAL (B$): IF B = 1 THEN
   X = 2:Y = 2
260 IF B = 2 THEN X = 15:Y = 2
280 IF B = 3 THEN X = 28:Y = 2
300 IF B = 4 THEN X = 2:Y = 15
320 IF B = 5 THEN X = 15:Y = 15
340 IF B = 6 THEN X = 28:Y = 15
360 IF B = 7 THEN X = 2:Y = 28
380 IF B = 8 THEN X = 15:Y = 28
400 IF B = 9 THEN X = 28:Y = 28
420 FOR D = 1 TO I: IF B = G(D) THEN
   GOSUB 50: GOTO 220
440 NEXT :G(I) = B
500 ON J GOSUB 1100,1000
519 REM *** CHECK FOR WIN ***
520 IF SCRN( 2,2) = C AND SCRN(
   15,2) = C AND SCRN( 28,2) =
   C OR SCRN( 2,15) = C AND SCRN(
   15,15) = C AND SCRN( 28,15)
   = C OR SCRN( 2,28) = C AND
   SCRN( 15,28) = C THEN 3000
530 IF SCRN( 2,2) = C AND SCRN(
   2,15) = C AND SCRN( 2,28) =
   C OR SCRN( 15,2) = C AND SCRN(
   15,15) = C AND SCRN( 15,28)
   = C OR SCRN( 28,2) = C AND
   SCRN( 28,15) = C AND SCRN(
   28,28) = C THEN 3000
540 IF SCRN( 2,2) = C AND SCRN(
   15,15) = C AND SCRN( 28,28)
   = C OR SCRN( 28,2) = C AND
   SCRN( 15,15) = C AND SCRN(
   2,28) = C THEN 3000
560 NEXT
580 HOME : PRINT "NOBODY WON IN
   THAT GAME": GOTO 3010
999 REM *** DRAW CROSS ***
1000 C = 5: COLOR= C: PLOT X,Y: PLOT
   X + 1,Y + 1: PLOT X + 2,Y +
   2: PLOT X + 3,Y + 3: PLOT X +
   4,Y + 4: PLOT X + 5,Y + 5: PLOT
   X + 6,Y + 6: PLOT X + 7,Y +
   7: PLOT X + 8,Y + 8
1010 PLOT X,Y + 8: PLOT X + 1,Y +
   7: PLOT X + 2,Y + 6: PLOT X +
   3,Y + 5: PLOT X + 4,Y + 4: PLOT
   X + 5,Y + 3: PLOT X + 6,Y +
   2: PLOT X + 7,Y + 1: PLOT X +
   8,Y
1020 RETURN
1099 REM *** DRAW NOUGHT ***
1100 C = 9: COLOR= C: HLIN X,X +
   8 AT Y: HLIN X,X + 8 AT Y +
   8: VLIN Y,Y + 8 AT X: VLIN Y
   ,Y + 8 AT X + 8: RETURN
1110 VLIN Y,Y + 8 AT X
3000 HOME : PRINT N$(J)" WINS"
3010 VTAB 22: HTAB 1: PRINT "AND
   THER GAME <Y/N> ? " ; GET B$
   : IF B$ = "Y" THEN CLEAR : TEXT
   : HOME : GOTO 120
3020 IF B$ < > "N" THEN GOSUB
   50: GOTO 3010
3030 TEXT : HOME : END
4000 HOME : VTAB 1: HTAB 11: INVERSE
   ; PRINT "NOUGHTS AND CROSSES
   ": NORMAL
4020 HTAB 2: VTAB 5: PRINT "THE
   OBJECT OF THIS GAME IS TO LI
   NE"
4030 HTAB 2: VTAB 7: PRINT " ALL
   YOUR SYMBOLS IN A LINE."
4040 HTAB 2: VTAB 9: PRINT "YOU
   ALSO HAVE TO STOP YOUR OPPON
   ENT,"
4050 HTAB 2: VTAB 11: PRINT " FR
   OM DOING THE SAME."
4060 VTAB 19: HTAB 6: FLASH : PRINT
   " HIT ' RETURN ' WHEN READY
   " ; GET A$
4070 IF ASC (A$) < > 13 THEN 4
   060
4080 NORMAL : HOME : RETURN

```

FOR THE LOWEST PRICES AROUND PHONE 09277 68211

*Checkout our complete range of printers, monitors, interfaces, ribbons,
diskettes and a host of accessories*

MONITORS / PRINTERS		INTERFACES	
DESCRIPTION	ORDER CODE	DESCRIPTION	ORDER CODE
KAGA MONITORS		EPSON INTERFACES	
Kaga 12" Green Monitor (Hi-Res)	KG12NB-N	Epson Non-Graphics Card + Cable For Apple II & Ile (Suitable for MX, FX & RX range)	EP/APP1
Kaga 12" Amber Monitor (Hi-Res)	KG12NB-MN	RGB Cable for BBC to Kaga RGB Vision Series	RGB/BBC
Kaga 12" RGB/PAL Colour Monitor (Med-Res)	K12R1X	Epson Graphics Card + Cable For Apple II & Ile (Suitable for MX, FX & RX range)	EP/APP2
Kaga 12" RGB Colour Monitor (Hi-Res)	K12R2	Epson RS232 I/F Card (Suitable for FX & RX range)	8143
Kaga 12" RGB Colour Monitor (Super Hi-Res)	K12R3	Epson RS232 I/F Card + 2K Buffer 75-9600 baud DTR handshake (Suitable for MX, FX & RX range)	8145
Kaga 12" RGB Colour Monitor for IBM PC (Hi-Res)	K12R3PC	Epson RS232 I/F Card Type 3 + 2K Buffer 75-300 baud Xon/Xoff (Suitable for MX, FX & RX range)	8146
KAGA ACCESSORIES.		Epson RS232 I/F Card + 2K Buffer (Suitable for FX/RX range)	8148
RGB Interface Card and Cable for Apple II	RGB/A2	Epson IEEE-488 I/F Card (Suitable for MX, FX & RX range)	8161
RGB Interface Card and Cable for Apple Ile	RGB/A2e	Epson IEEE-488 I/F Card (Suitable for FX/RX range)	8165
Multi-Mode RGB Colour Card for Apple II (inc cable)	RGB/A24	Epson 2K Parallel Buffer (Suitable for FX/RX range)	8171
Multi-Mode RGB Colour Card for Apple Ile (inc cable)	RGB/A24e	Epson TRS-80 I/F board (Suitable for MX, FX & RX range)	8120
RGB Cable for Apple III to Kaga RGB Vision Series	RGB/A3	Ribbon for Epson MX80, MX82 & RX80 printers	EP/R
RGB Cable for IBM P/C to Kaga RGB Vision Series	RGB/IBM	Ribbon for Epson MX100 printer	EP/100/R
BROTHER PRINTERS		Epson - BBC Parallel Cable	EP/BBC
18 cps Daisywheel Printer (Parallel)	HR15/P	APPLE INTERFACES	
18 cps Daisywheel Printer (Serial)	HR15/S	CCS Serial Interface Card	CCS
Keyboard Attachment for HR15	KB50	Mountain Hardware CPS Multifunction Interface Card (Clock/Serial & Parallel Card)	MHP-X031
Tractor Feed for HR15	TF50	CPS Printer Cable (Please Specify)	CPS/P
Cut Sheet Feeder for HR15	CF50		
EPSON PRINTERS			
Epson FX80 Dot Matrix (160 cps)	FX80		
Epson FX80 Adjustable Tractor	FX80T		
Epson RX80 Dot Matrix (100 cps)	RX80		
Epson RX80FT Dot Matrix (100 cps)	RX80FT		
Epson MX100 Type 3 Dot Matrix (100 cps)	MX100		
Epson FX100 Dot Matrix (160 cps)	FX100		

EX-STOCK DELIVERY

Access cards welcome

LOW CARRIAGE CHARGES

Only £5 per Printer/Monitor (UK mainland)

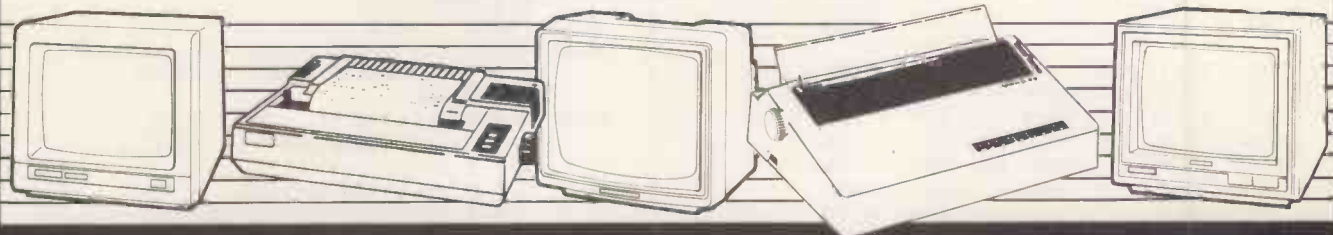

PHONE 09277 68211



FOR LOWEST PRICES AROUND

Aimgram Limited, 31 Roman Gardens,
Kings Langley, Hertfordshire WD4 8LG

**BBC 'B' AVAILABLE
AT LOW COST
TOO**

Plain tales of the BBC Micro

Simon Beesley makes his selection from recent books on Acorn's machine.

AMONG ALL the home computers, the BBC Micro's graphics are second to none. BBC Basic is exceptionally well furnished with graphics commands. It is also fast enough to create animated displays without recourse to machine code. Equally important is the way the machine allows you to assign a colour to each individual pixel, a feature not found on any other computer under £1,000.

Although there are already several books on making pictures with the BBC, new titles on the subject are welcome. One of them is *Graphics on the BBC Microcomputer* written by the Cryer family, Neil, Pat and Andrew. Like so many other BBC books it is written in the style of a school textbook, presumably because the BBC Micro is so popular in schools.

At the end of each chapter there is an activities section followed by a discussion of activities. There is no place here for slackers. The authors' tone of voice is schoolmasterly and they constantly encourage you to join in. Most parts of graphics syllabus are dealt with: designing characters, animating displays, adding perspective, graphs, pie charts, histograms, and so on. They are not treated in any depth of detail and so the course is fairly easy going.

Lacks imagination

Accompanying the book there are a number of demonstration programs. By and large they are a little unexciting and they do not show quite the spectacular effects the BBC machine is capable of. My end of term report on this one would be: tries hard but lacks imagination.

If the Cryers' book is a graphics primer, *Advanced Graphics on the BBC Model B* by I O Angell and B J Jones definitely falls into the heavyweight category. Before tackling it you will need to brush up your knowledge of vectors and matrices. It covers the field pretty thoroughly, from two-dimensional transformations right through to stereoscopic and perspective transformations.

The final chapters present a general-purpose algorithm for removing hidden lines and surfaces. As the authors point out, this is approaching the limits of the BBC machine's processing power. By the time I reached this section my own



processing power was fully stretched. But if you find the mathematics daunting, as I did, you can simply key in the listings.

Boris Allan's *Graphic Art for the BBC Computer* is as much about turtle graphics as art — and the two are not necessarily connected. BBC Basic's procedures make it easy to implement Logo-style commands. Boris Allan supplies the necessary program listings while explaining the concepts and uses of turtle graphics. There are also two chapters which deal with designing characters and drawing charts and graphs.

Along the way the author argues for the value of turtle graphics as a learning aid and a spur to the imagination. He spoils his case slightly by harping on about "art" and "creativity". The designs produced by turtle graphics may be pleasing or interesting but they are not artistic, except in the trivial sense of the word.

Why, also, does Boris Allan insist on calling the book's pictures icons? In a lot he argues unconvincingly that they should be termed icons rather than figures since they have been output to a printer. This is the first time I have seen a graphics dump referred to in such terms. The book has a whiff of pretentiousness.

Still, as you might expect from Boris Allan, the book is rich in ideas. When it is not concerned to justify its title it makes a good introduction to the theory and practice of Logo.

The best book on BBC graphics,

however, remains *Creative Graphics* by John Cownie, published by Acornsoft in 1982. It is essentially a commentary on a collection of demonstration programs. What makes it so impressive is the quality of these programs. They are all written in Basic but achieve effects which on other machines are obtainable only in machine code, if at all.

Kaleidoscope

With just a few lines of code the author manages to produce effects such as a tumbling wire-frame box or a rapidly changing kaleidoscope. Most of the ways of exploiting BBC Basic's scope for graphics were first described here, from the use of palette changes to give animation, to the use of recursion to draw intricate curves. They are explained clearly and concisely.

The introduction maintains that "programs like these are usually consigned to a backroom inhabited by hairy programmers, only to be revealed to the public at exhibitions . . .". It is often the case that books like this, written by professional programmers, are more valuable than the works of technical writers or computer journalists, since computing professionals will have acquired from their working experience a greater range of useful techniques.

(continued on next page)

(continued from previous page)

This contrast is made apparent by two new books about BBC disc systems. *The BBC Microcomputer Disk Companion* is written by Tony Latham, an electronics engineer. It is badly produced, clumsily written and marred by spelling mistakes and typographical errors. The word "dialogue", for instance, is given as "dialog"; elsewhere you are advised to set Page to E001 instead of E00.

Saving grace

The book's saving grace is that the author is thoroughly familiar with his subject. After a tour of the disc commands you are taken through the problems of creating serial and random-access files. From there you proceed to some useful chapters which deal with file handling from assembly language and formatting a disc.

Ian Sinclair, on the other hand, is an experienced writer on computing. His *Disk Systems for the BBC Micro* makes for smoother reading but is less informative. He gives an excellent generation introduction to discs, which includes a comparison between several different disc filing systems, not just Acorn's but also the Amcon and Watford systems. His explanations are much clearer than Tony Latham's, making this a more suitable book for the newcomer to computing.

Geof Wheelwright's *The Companion to*

the BBC Micro purports to be the complete reference companion for the BBC user. It is hardly that, and in fact would be better described as a mish-mash of BBC facts and tips. It is the sort of book any fairly experienced user would produce if they sat down and wrote out everything they knew about the BBC Micro.

Some of the tips are quite useful; some of them are the sort you might glean from conversation with another user; and some are merely repetitions of material found in the manual. The trouble with this approach is that it is extremely uneven. In one chapter the author talks at length about word processing and discusses specific products

such as Wordwise and View. Elsewhere, applications like robotics or the use of sound are just mentioned in passing.

When it acts as a buyer's guide the book is again rather patchy. It covers the Torch disc system in detail but glosses over other alternatives to Acorn's disc filing system. You get the impression that the author just happened to have a Torch system handy and decided to go to town on it.

At the back there are 11 appendices containing some useful routines and a reduced list of VDU and Osbyte calls. Even with this extra padding the book only stretches to 124 pages. It is far too slim a volume to call itself a reference guide. **2**

Graphics on the BBC Microcomputer by Neil, Pat and Andrew Cryer. published by Prentice-Hall International, £6.95. ISBN 0 13 363283 0

Advanced Graphics with the BBC Model B Microcomputer by I O Angell and B J Jones. Published by Macmillan Press, £9.95. ISBN 0 333 35052 9

Graphic Art for the BBC Computer by Boris Allan. Published by Sunshine Books, £5.95. ISBN 0 946408 08 4

The BBC Microcomputer Disk Companion by Tony Latham. Published by Prentice-Hall International, £7.95. ISBN 0 13 069311 1

Disk Systems for the BBC Micro by Ian Sinclair. Published by Granada Publishing, £6.95. ISBN 0 246 12325 7

The Companion to the BBC Micro by Geof Wheelwright. Published by Pan Books, £4.95. ISBN 0 330 28263 8

Creative Graphics by John Cownie. Published by Acornsoft, £7.50. ISBN 0 907 876 03 X

COLOUR MONITORS

Microvitec 1431	£219.00
Microvitec 1451	£339.00
Fidelity CM14	£209.00

Monochrome Monitors

Sanyo DM2112	£75.00
Sanyo DM8112CX	£99.00

Combined TV/Monitors

ITT RL2301	£280.00
------------	---------

Daisywheel Printers

Juki 6100	£379.00
Silver Reed	£309.00
Daisy Step 2000	£289.00

Daisywheel add-ons

Juki Sheet feeder	£239.00
Juki Tractor feed	£109.00

Dot Matrix Printers

Seikosha GP50A	£109.00
Seikosha GP100A	£169.00
Seikosha GP250X	£209.00
Seikosha GP500G	£189.00
Seikosha GP550A	£259.00
Seikosha GP700A	£359.00
Star Delta 10	£365.00
KDC FT-5001	£259.00
Epson RX80	£249.00
Epson RX80 F/T	£279.00
Epson FX80	£379.00

Serial Interface Conversions

8143 - Epson	£30.00
8148 - Epson (2K buffer, XON/XOFF protocol)	£65.00
Juki	£55.00

Single Disc Drives

100K(200K) Single-Sided	
40 Track	£150.00
200K(400K) Double-Sided	
40 Track 3-inch	£190.00
400K(800K) Double-Sided	
80 Track	£219.00

Double Disc Drives

400K(800K) Double-Sided	
40 Track 3-inch	£374.00
800K(1.6M) Double-Sided	
80 Track	£409.00

BBC Disk Interfaces

Kenda Mighty Oak	£90.00
Kenda Professional (Double Density)	£130.00

Acorn Products

BBC Model B	£399.00
BBC Model B with fitted disc interface	£469.00
Electron	£199.00
DFS Kit	£97.00

Supplies/Consumables etc

Ribbons, Cables, Paper, Floppies - all at DISCOUNT prices

DISCOUNT SOFTWARE

A&F

180 Darts	£6.00
Chuckie Egg	£7.00
Cylon Attack	£7.00
Horror Castle	£7.00
Howzat	£6.00
Pharaoh's Tomb	£7.00
Shrinking Professor	£7.00

Program Power

Adventure	£7.00
Alien Swirl	£6.00
Asteroid Storm	£7.00
Bandits at 3 o'clock	£6.00
Beebmon	£7.00
Bumble Bees	£7.00
Caveman Adventure	£6.00
Chess	£7.00
Cosmic Combat	£6.00
Cowboy Shootout	£6.00
Croaker	£7.00
Cybertron Mission	£7.00

Computer Concepts

Android Attack	£8.00
Asteroid Belt	£7.00
Chess	£8.00
Draughts	£8.00
Swarm	£8.00
Snake	£8.00
Space Hawks	£7.00

Computer Concepts

ROMs	
Disc Doctor	£32.00
Termi	£32.00
Wordwise	£42.00

Level 9

Adventure Quest	£9.00
Colossal Adventure	£9.00
Dungeon Adventure	£9.00
Lords of Time	£9.00
rqForth	£14.00
rqFORTH Toolkit	£11.00
Snowball	£9.00
Danger UXB	£7.00
Demon Decorator	£6.00
Draughts	£6.00
Draw	£9.00
Escape from Moonbase Alpha	£7.00
Felix & Fruit Monsters	£7.00
Felix in the Factory	£7.00
Filer	£9.00
Galactic Commander	£7.00
Helldriver	£7.00
Intergalactic Trader	£8.00
Killer Gorilla	£7.00
Labyrinths of LaCoshe	£7.00
Laser Command	£7.00
Martian Attack	£7.00
Moon Raider	£7.00
Nemesis	£7.00
Positron	£6.00
Timetrek	£7.00
Space Jailer	£6.00
Swoop	£7.00
Wizard's Challenge	£7.00
Zarm	£7.00

ALL PRICES SHOWN INCLUDE V.A.T. THESE PRICES ARE FOR CASH AND CARRY SALES

microFAST

57 HOXTON SQUARE, LONDON N1
OPEN FOR PERSONAL CALLERS FROM MONDAY TO SATURDAY 9AM TO 6PM
MAIL ORDER OF OTHER ENQUIRIES
01-729 1778
SAE for comprehensive Price List

Product range constantly expanding, phone for latest details

**Earls
Court**

**June
14***

If you have considered how beneficial a microcomputer could be in your work The Computer Fair is the perfect opportunity to see all the latest business and professional computers under one roof.

By investing a little of your time to find out what the computer for business is all about you may find it pays handsome dividends – so make sure of your visit to The Computer Fair.

'THE COMPUTER FAIR MEANS BUSINESS'

A special section devoted to computer hardware and software for business applications means you can assess the benefits of computing quickly and easily with expert advice always on hand.

Because the first day of the show is for trade and business visitors only, you can be admitted free by presenting your business card at the door. As the show is held at Earls Court you can get to it easily by car, bus or tube.

**THE
Computer
Fair** *Personal computers
Home computing
Small business systems*

* FREE ADMISSION FOR BONE FIDE BUSINESS PERSONS ON PRESENTATION OF A BUSINESS CARD. PUBLIC DAYS JUNE 15-16-17
Opening times: 10 – 6 daily 10 – 5 last day

173

Sponsored by

**YOUR
COMPUTER**

**Practical
Computing**

**micro
business**

**COMPUTER
CHOICE**

DISKING means business

DISKING MEANS BUSINESS

*FREE PEN for ALL Computer Users *

Write or call (24hr answering) for our General Price List. Name this magazine and you will get your pen.

OUR business is here to serve YOUR business, and if you don't find us the slickest and most reliable UK disk supplier - we'll refund your monies in full. UK P&P is free, if we can't ship inside 4 working hours!

FREE WITH EVERY TEN-PACK OF DISKETTES FROM DISKING

1. SEE 10 LIBRARY BOX
The Superb See 10 library box for storing and displaying ten diskettes. Available individually at £2.50 exc VAT, see under 'Diskette storage



PLUS
2. Disking 'COLOUR CODERS'
A multicoloured pack of ten fibre tipped pens for colour coding your diskette labels. Available individually at 49p exc VAT per pack of ten

MEMOREX

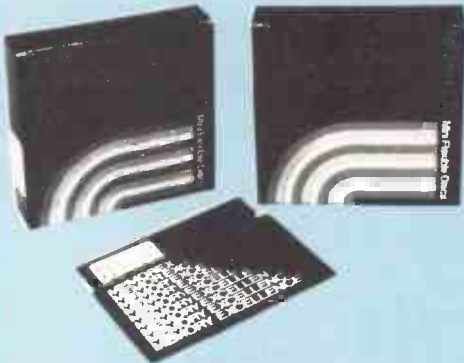

MEMORY EXCELLENCE

Memorex diskettes will work well in ANY computer - they have a reputation which is second to none.

5 1/4" DISKETTES

Certified for single OR double density and with hub ring reinforcement.

PRICES EXC VAT

	10-40	50-90	100+
3481 S S 48 tpi	21.90	20.90	19.90
3491 D S 48 tpi	27.90	26.90	25.90
3504 S S 96 tpi	27.90	26.90	25.90
3501 D S 96 tpi	35.90	34.90	33.90

48 tpi suitable for 35 or 40 track

96 tpi suitable for 77 or 80 track

10 & 16 Hard Sector at same prices

maxell



MAXELL - The Gold Standard

Maxell's newly packaged diskettes, consistently meet or exceed all standards. A quality to match the best.

5 1/4" DISKETTES

Certified for Single OR Double Density 48 tpi media with hub ring

PRICES EXC VAT

	10-40	50-90	100+
MD1-D S S 48 tpi	24.90	23.90	22.90
MD2-D D S 48 tpi	32.90	31.90	30.90
MD1-DD S S 96 tpi	32.90	31.90	30.90
MD2-DD D S 96 tpi	42.90	41.90	40.90

48 tpi suitable for 35 or 40 track

96 tpi suitable for 77 or 80 track

10 & 16 Hard Sector at same prices

8" DISKETTES

PRICES EXC VAT

	10-40	50-90	100+
FD1-128 S S S D	29.90	28.90	27.90
FD1-XD S S D D	34.90	33.90	32.90
FD2-XD D S D D	39.90	38.90	37.90

32 Hard Sector available at same price

Dysan



Dysan Quality maintained - prices reduced

DYSAN

With new lower prices Dysan's impeccable reputation is now a bargain. Go on, spoil yourself

5 1/4" DISKETTES

Certified for Single OR Double Density, and all with Hub Ring reinforcement

PRICES EXC VAT

	10-40	50-90	100+
104 1D S S 48 tpi	23.90	22.90	21.90
104 2D D S 48 tpi	34.90	33.90	32.90
204 1D S S 96 tpi	34.90	33.90	32.90
204 2D D S 96 tpi	42.90	41.90	40.90

48 tpi suitable for 35 or 40 track

96 tpi suitable for 77 or 80 track

10 & 16 Hard Sector at same prices

8" DISKETTES

PRICES EXC VAT

	10-40	50-90	100+
3740-1 S S S D	29.90	28.90	27.90
3740 1D S S D D	32.90	31.90	30.90
3740-2D D S D D	40.90	39.90	38.90

32 Hard Sector available at same price

DISKING 'SHATTERING' OFFER



To prove just how good MEMOREX are, we at Disking are packing a FREE MEMOREX C-90 Cassette tape with every ten-pack of MEMOREX floppies until June 30th 1984. This offer does not affect any of our other promotions, and is in addition to them.

DISKETTE ACCESSORIES

'PERFECT DATA' CLEANING KIT

In our experience the only cleaning kit that really works, and works reliably.

Part No:	Description	Price
CK5	For 5 1/4" Drives	14.90
CK8	For 8" Drives	14.90

5 1/4" DISKING SUPERMAILERS

Will mail up to 4 diskettes in their envelopes, and very rigid due to copyright design. Packed in 100's.

Part No:	Desc.	100	200	300
DSM	Mailers	24.90	22.90	19.90

DISKETTE STORAGE

Disking Swing Lid Box NEW Product! STORES 60 MINIDISKS

Keep your lid on with the new superior anti-static Disking lockable swing-lid box with convenient hinged smoked perspex lid, dividers and two keys. Always keeps your disks in perfect condition and even has concealed carrying handles front and rear for your convenience.

RRP is 21.50. Our price exc VAT is just

Part No:	Description	1-3	4-
DSL8	60 Minidisk capacity	17.90	15.90

Packed individually and 4 to an outer carton



SONY

	10-40	50-90	100+
3 1/2" MICRODISK	42.90	41.90	40.90

(Auto shutter 0.5 MByte rating)

No library box available yet - sorry

How To Contact DISKING:

By Telephone: (0428) 722563
 By Telex: 858623 Telbur G
 By PRESTEL: Page 2477310 – Please allow 5 days for the order to reach us.
 By FAX: (0252) 721521

DISKING INTERNATIONAL
 FREEPOST
 LIPHOOK
 HAMPSHIRE
 GU30 7BR
 UNITED KINGDOM

U.K. SHIPPING RATES INC. INS. BUT EXC. VAT

5 1/4" DISKETTES 1-2 PACKS each pack @ 95p 3-5 PACKS each pack @ 75p 6-9 PACKS each pack @ 60p 10+ PACKS * POST FREE * 5 1/4" CLEANING KITS Same postal rate as packs of 5 1/4" diskettes, 10+ POST FREE	8" DISKETTES 1-2 PACKS each pack @ 1.60 3-5 PACKS each pack @ 1.20 6-9 PACKS each pack @ 90p 10+ PACKS * POST FREE * 8" CLEANING KITS Same postal rate as packs of 5 1/4" diskettes, 10+ POST FREE	5 1/4" NEW 'SEE 10' LIBRARY BOXES SEE 10 5-9 off @ 30p SEE 10 1-4 off @ 40p SEE 10 10+ @ 20p 8" LIBRARY BOXES LB8 1-4 off @ 60p LB8 5-9 off @ 45p LB8 10+ @ 30p	DISKING SUPERMAILERS (5 1/4" only) 100-PACK 3.00 DISKING COLOUR CODERS 10-Pack Multicolours 25p LOCKABLE DISKETTE STORAGE All versions: 1 off 2.00, 2-7 off 1.30 each, 8+ post free
--	--	--	---

Verbatim®



Datalife – Five Year Warranty
 It's easy to see why they're the world market leaders. Perfect data retention everytime – for a lifetime – Datalife.

5 1/4" DISKETTES
 Certified for Single OR Double Density, and all with Hub Ring reinforcement
PRICES EXC VAT

	10-40	50-90	100+
MD525 S/S 48 tpi	22.90	21.90	20.90
MD550 D S 48 tpi	29.90	28.90	27.90
MD577 S/S 96 tpi	28.90	27.90	26.90
MD557 D S 96 tpi	36.90	35.90	34.90

48 tpi suitable for 35 or 40 track
 96 tpi suitable for 77 or 80 track
 10 & 16 Hard Sector at same prices

8" DISKETTES
PRICES EXC VAT

	10-40	50-90	100+
FD34-9000 S/S S/Dens	31.90	30.90	29.90
FD34-8000 S/S D Dens	31.90	30.90	29.90
DD34-4001 D/S D/Dens	36.90	35.90	34.90

32 Hard Sector available at same price

Verbatim®



VEREX
 Verbatim Verex come with a full one year warranty but at a very popular price – you can't lose!

5 1/4" DISKETTES
PRICES EXC VAT

	10-40	50-90	100+
MD200-01 S S S D Soft	19.90	18.90	17.90
MD200-ASS S S D Apple	19.90	18.90	17.90

8" DISKETTES
PRICES EXC VAT

	10-40	50-90	100+
FD34-1500 S S S D Soft	22.90	21.90	20.90
FD32-1500 S S D D Hard	22.90	21.90	20.90
DD34-1501 D S D D Soft	29.90	28.90	27.90

**** STOP PRESS ****

400 Brand New, Unlabelled Grey Supertuxe Disk Libraries (20 minidisk capacity) at half price to clear. Minimum order quantity 10 pieces.
Only ... 4.90 each. (3.00 p&p per 10, 30+ FREE)
 This offer is open to the trade OR end users.
 First come first served.

NORMAL ORDERS – WE NOW WELCOME ALL OFFICIAL GOVERNMENT ORDERS

We welcome orders from all Government Bodies including Schools, Universities, Colleges, Hospitals, the Utilities, Research Establishments, Armed Forces, the Ministries and local Authorities etc. We will despatch within 4 working hours from receipt of your official order number received either by post or over the telephone
 Everyone else cheques with order please payable to DISKING. If you are a large establishment and cannot raise cheques without an invoice please post or telephone us with your order and we will send a pro-forma invoice by return, for your accounts department to pay against. Also bear in mind, that you do have to pay VAT, which will be added to these prices.
 If you are in any doubt, please telephone us for assistance.

CREDIT CARD ORDERS

We welcome Access (Mastercharge), Barclaycard (VISA) & Diners Club International. & there is NO credit card surcharge. You may write your C Card No. on your order or telephone the order day or night 365 days a year. You may speak for as long as you like (but please speak up and don't leave long gaps otherwise our machine thinks you've gone home) and don't forget to give the following details:
 1. Day time telephone number
 2. Cardholder Name & Address
 3. Delivery Invoice Address if different
 4. Your Credit Card Number
 5. Part Nos and quantity of what you wish to order
 6. Normal, First Class or Special Post
YOU MAY LEAVE THE REST TO US!!

URGENT ORDERS

If you're posting your order, omit the word FREEPOST from our address, and use our normal postcode GU30 7EJ and do not forget to stamp it FIRST CLASS. If you are a Government body as defined under 'NORMAL ORDERS' and are telephoning your official order OR are an individual or company using your Credit Card No. please make it clear that you wish to pay for your goods to be sent to you by FIRST CLASS POST.

FIRST CLASS RATES

EXC VAT	5 1/4"	8"
First TEN-PACK	2.00	2.50
Second & subsequent TEN-PACK	1.50	2.00

DESPERATE ORDERS U.K.

Your options are:
 DATAPOST Next day U.K. – order by 3.00pm or:
 EXPRESSPOST Same day (ENGLAND) – order by 10.30am
 Please telephone for further information.
PRICES SUBJECT TO EXCHANGE RATES & AVAILABILITY

DISKETTE STORAGE

SEE 10 LIBRARY BOXES
 Stores 10 Minidisks AND when open displays them all at the same time – Quite simply the best library box there is!
PRICES EXC VAT

Part No:	Description	1-49	50-
SEE 10	Library Box	2.50	2.20
LB8	Library Box	3.00	3.00

ABA LOCKABLE DISKETTE STORAGE
 These storage boxes come in four sizes, two for mini disks and two for 8 disks.
 They hold 40 or 80 diskettes and come complete with keys and dividers.

PRICES EXC VAT

Part No:	Description	Price
M35	40 minidisk capacity	14.90
M85	80 minidisk capacity	18.90
F40	40 8" diskette capacity	18.90
F80	80 8" diskette capacity	27.90

HARD DISKS & SOFTWARE

HARD DISKS FOR YOUR MICRO
 We can supply Hard Disk sub systems for most micros – 5Mb from 1190.00 up to 40MB from 2480.00 – please call for details.

SAGE BUSINESS SOFTWARE
 With a SAGE fully integrated Sales, Nominal & Purchase ledger system costing only 375.00 how can you go wrong?
 In fact they even let you try-before-you-buy for only 20.00, and refund that against your purchase. Please call for a full list of packages and prices.
 We will enclose a FREE pack of ten diskettes with every SAGE software package sold.

TRADE CORNER

**** FREE AEROPLANE ****

Being in the micro trade means you're dynamic and energetic but probably sit in front of your VDU too long like we do. So we've devised a way of getting you out into the fresh air – an aeroplane that flies. Just call and ask for your flier and of course we'll send you our 1984 trade price list (Yes it's printed at last and even our secretary can't believe it) We'll include your FREE sample unlabelled diskette and supermailer AND an application form for a DPC card to enable you to buy at our 10,000 prices yet order only in '50s.



Cord Designs Limited

**AUTHORISED DEALERS FOR A.C.T. & DIGITAL
LOTUS 1-2-3, SILICON OFFICE, WP2020**

Plus comprehensive range of computer supplies.

We stock Sirius, Apricot, Rainbow, Decmate II, Professional

Complete the coupon for details of the special offer that relates to YOUR business

**CORD DESIGNS LTD., VICTOR HOUSE,
NORRIS ROAD,
STAINES, MIDDLESEX, TW18 4DS
0784 56601**

PLEASE SEND DETAILS OF:
NAME _____
BUSINESS _____
ADDRESS _____
COMPANY _____
TEL. NO. _____

● Circle No. 261

MAINS PROBLEMS?!!!

There is only one cure:

BATT POWER

Features:

- * The uninterruptable power supply
- * Immediate mains supply in the event of a power failure
- * Sinsoidal output voltage
- * Regulated output voltage using a CONSTANT VOLTAGE TRANSFORMER
- * Quartz frequency controlled output
- * Transient and noise suppression
- * High overload capacity
- * Separate battery compartment
- * Fast recharge time.

180-600 VA UNITS NOW
AVAILABLE

BACK-UP TIME TO SUIT
CUSTOMER REQUIREMENTS

Prices starting from £460

Ex works, ex VAT

Call this number for technical
information, price and delivery:

AS featured in the ACT product catalogue

021 236 6220/1226

**Eccleston Electronics
Eccleston & Hart Ltd
8 Legge Lane Birmingham B13 LG**

● Circle No. 262

MORE SHOCKING NEWS!

(limited period clearances)

EPSON Printers	from	£209
SHINWA Printers		£185
DISCS (BASF)		£1.00 each
DISC CASES		£1.50 each
BBC Printer Leads		£10.00 each
STAR Printers	at	£199
DAISYWHEEL Printers	from	£280

Phone 0962 66191 for
MORE SHOCKING NEWS

- Nationwide delivery £5 per parcel.
- DISCS from £1.00

All prices ex VAT and subject to availability.



micro miracles

50A Stockbridge Road, Winchester, Hants
SO22 6RL England

• Circle No. 255

SOFTWARE PROFESSIONALS

THORN EMI is looking for innovative, top-quality software to incorporate into a best-selling range of home computer products.

If you are an experienced software author, and you've come up with an interesting, professionally produced piece of entertainment, educational or home management software, we'd like to hear from you.

Your talents lie in programming and design. Ours are in marketing and distribution. Together, we could put your program into homes all over the world.

So don't waste time.

Call Patricia Mitchell on 01 437 3453

or write to us:

Acquisitions Dept, THORN EMI Software,
5th Floor, Film House, 142 Wardour Street
London W1V 4PT

• Circle No. 191

>NEXT MONTH

>IBM PC SPECIAL

The IBM PC has now established itself as the world's leading micro, and IBM keeps adding to the line-up — the Portable PC is only the most recent example. Other major manufacturers are now announcing or delivering machines compatible with it, including Olivetti, Philips, ITT and others. So it's time to take a closer look at Big Blue's micro and its emulators. We will be reporting on how compatible some of the leading compatibles really are, reviewing some of the exciting new software — including The Incredible Jack 2 — and exploring the wonderful world of add-on boards.

>REVIEWS

Hardware on the test bench for June includes the Wren, a £1,000 semi-transportable that comes with a built-in modem for making the Prestel/Micronet connection and lots of free software. We will also have news of the new Amstrad home micro. Scheduled software items range from Ashton-Tate's Friday, through a survey of half a dozen word processors on the BBC Micro to Apple books.

>AND MUCH MORE

The wired society: our telesoftware series continues with a look at Micronet and the cable TV scene.

Budget Business micros: our survey of available micros looks at what you can get for around £1,000 to £1,500. There will be the usual special programming features, and a round-up of news, with new launches from the Hanover Fair from Commodore and Osborne, among others. Not to mention the pages of free software in Open File.

Make sure you don't miss the June issue of

Practical Computing

On sale at W H Smith and all good newsagents after May 16.

Contents may vary due to circumstances beyond our control, and are subject to change without notice.

THE BIG



- ★ Europe's No 1 group of retail outlets
- ★ Check our multi-national network for your nearest dealer
- ★ Backed by an after-sales service second to none
- ★ Up to £1,000 instant credit
Write for details

FOR

Computer Hardware and Software Nationwide

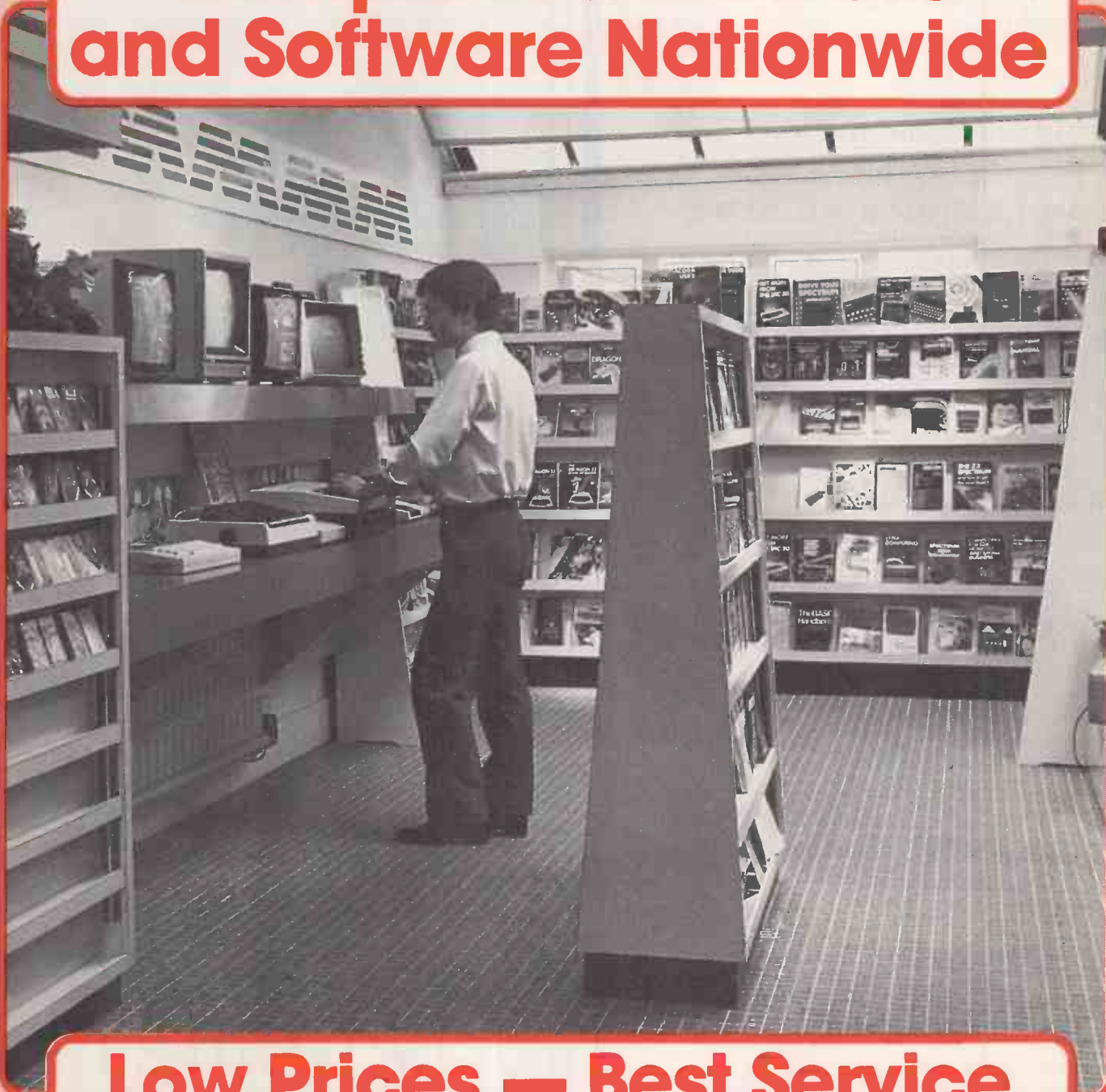

Low Prices — Best Service

at your local Big  Dealer

**Micro-Management Head Office:
16 Princes Street, Ipswich, Suffolk
Telephone: 0473 219461**

Discotek Announce a New Concept in Disks

FLIPPY-FLOPPY[®]

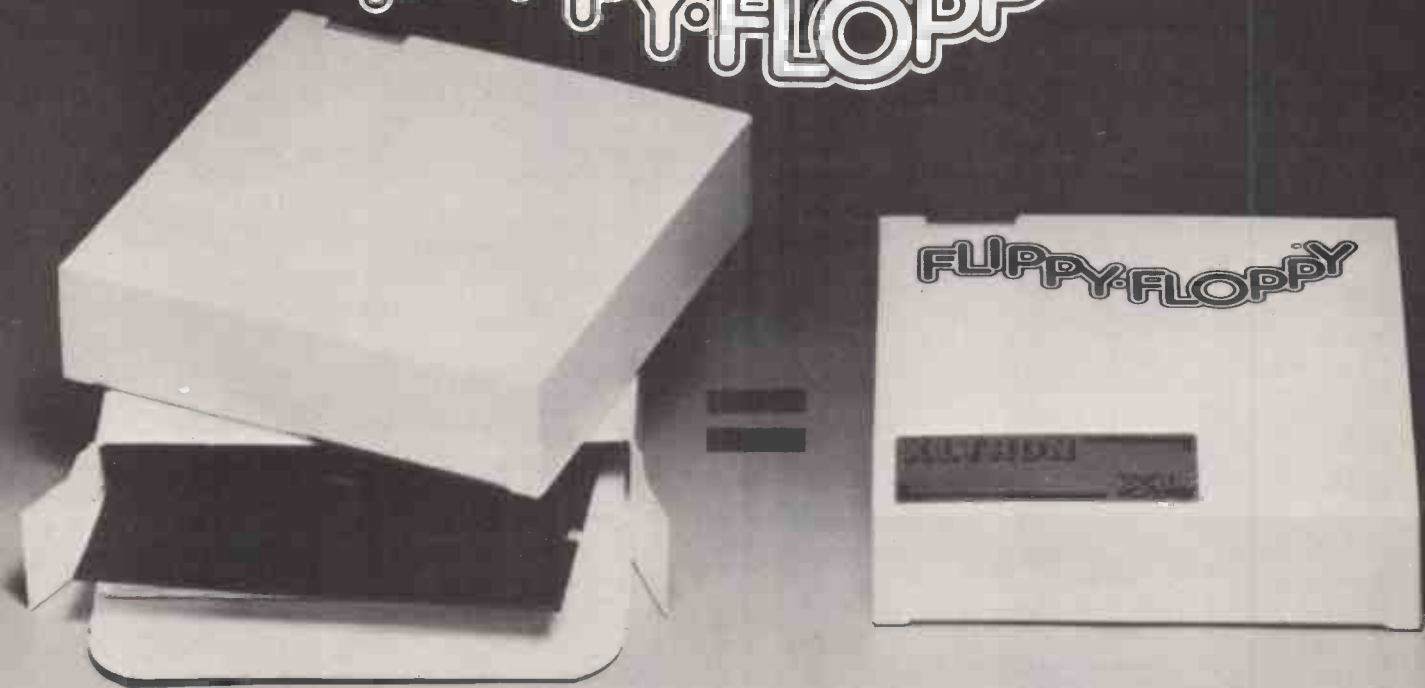

Double the capacity at half the cost!

If you're using single sided drives you can save yourself money, time and space with the **FLIPPY-FLOPPY[®]**

Single Density £1.99 each Double Density £2.99 each.

Quite simply all diskettes are capable of carrying data on both sides, but old-fashioned disks only have one read/write notch limiting the disk storage to one side. The **FLIPPY FLOPPY[®]** has two, doubling the storage – just take your disk out – flip it over – and put it back.

Factory-formatted too!

For BBC, Atari, Commodore, Apple, in fact any single sided drive.

We buy our disks in bulk from one of Americas major manufacturers. Then at our London laboratory we check and verify them to ensure the highest possible standards. With our 'state of the art' technology we format the disks for your machine at the same time. Result – we know the disk is *perfect* and you *save time and money too*.

Just imagine never having to format another disk again! And only another 10p each.

All disks carry our two-for-one five year guarantee

Join the **FLIPPY-FLOPPY** revolution – fill in the coupon below.

Disco Technology Ltd, 20 Orange Street, London WC2H 7ED.

Access holders ring 01-930 1612 and ask for Mike Hyman 10 a.m. – 4 p.m. for personal attention.

Please supply _____ (qty) single density Flippy-Floppy[®] _____ (qty) double density Flippy-Floppy[®]
 Non-formatted at £1.99 or £2.99 each respectively or formatted to my _____ (manufacturer) _____ (model)
 computer at an extra 10p per disk. (Please add 15% VAT) I enclose a cheque for £ _____
 or debit my Access card No. _____
 Name _____ Signature _____
 Address _____
 Postcode _____ Daytime phone no. _____

To Disco Technology Ltd,
 20 Orange Street,
 London WC2H 7ED

DISCO-TEK
 COMPUTER PRODUCTS

AT THE PRESENT time, when schools are encouraged to buy micros and reassured that they will prove their worth, many face a dilemma. They find themselves with thousands of pounds worth of computer equipment only to be perplexed as to how to use it properly.

Often schools find that their ideas are difficult to implement on the equipment they have bought. Frequently a few people in a school are familiar with computers, and the responsibility for developing the full potential of the micros rests with them. But the few computer-literates cannot be expected to produce all the necessary software, because of the time needed to do so.

Money wasted

Consequently educational software for the machines is purchased hastily, seldom lives up to expectations and hardly earns the titles "interesting" or "creative". The school is faced with both a lack of software and adequate knowledge, and so the expensive computer equipment lies dormant, not justifying the money invested in it.

There are, of course, great possibilities for computers in various subjects since they can simulate experiments, store information and carry out calculations. But a lot of the programs available at the moment are far too simple in content, and the work they do can be carried out more efficiently by other means. Certain practical problems also arise when using a computer in the classroom, for example when 30 students have to strain to observe vital occurrences on a small monitor.

What is needed

The problems of using computers in schools are by no means insurmountable but they demand consideration and careful planning. Consideration must be taken by schools as to how the micros are going to be used, exactly what equipment is needed and whether software can be purchased or written for the intended purpose. The Government should help in the development of software and the training of people to use micros, not simply subsidising them in hardware alone. Also, since the education software market is a vast and so far virtually untapped one, companies could both help and gain from the situation by producing quality programs.

Some examining boards are producing software to accompany their courses, but it is often dull. If the software used to teach subjects such as economics is uninteresting and too straightforward, then people will inevitably become bored and cease to benefit from its use. Someone who is interested will obviously learn more than someone who is not, an idea which should be kept in mind when producing programs.

A prime example of the interesting software that is available for use in

Education gone mad

by Jon Lansdell



'The school is faced with both a lack of software and adequate knowledge, and so the expensive computer equipment lies dormant, not justifying the money that has been invested in it'

education is Mule — multiple use labour element — which is marketed by Electronic Arts. The game can be played by up to four players and the aim is to transform the economy of an alien planet. Each player becomes a particular species represented by a separate character. The game then simulates the free-market system, with entertaining graphics making it enjoyable to play. Competition can be cutthroat with

Jon Lansdell is a sixth-form student and self-confessed "computer reactionary"

several players. Mule is an ideal piece of educational software and will hopefully prompt a more imaginative series of programs.

Until recently, the main use of computers in education was for computer studies itself. These courses seem to be outdated and develop much more slowly than new technology. Admittedly, examination papers have to be set a few years in advance, but it is the whole approach to the subject that is archaic. The courses seem to be geared to giving people familiarity with computers in such a way as to produce a nation of systems analysts.

Government's aim

Computer literacy is a stated government aim, with a computer in every school or educational establishment. Aims such as keyboard training for everyone at a simple level could be achieved. However, much greater depth and knowledge of such areas as high-level languages other than Basic — such as Cobol and Pascal — would be essential for the future of the British computer industry.

Problem analysis on a very basic level is included in courses but it would be much more useful if, for example, skills are taught which are directly relevant. What is the use of the abstract skills of twos complement, BCD and punched tape or punched cards? Actual programming skills form a part, usually as an assessed project, but are only worth a small percentage of the marks compared to the work involved.

Pointless essays

People should be encouraged to use their ideas. A continual-assessment system involving a large number of areas of programming techniques would be preferable to the existing one of writing irrelevant essays in a fixed time limit.

Future development of the computer industry depends on those who come out of today's education system. If they do not have the benefit of the right courses, or the encouragement to innovate, Britain may be wasting a valuable technological opportunity by not thinking of the future. □

Telephone Claire Notley on 01-661 8163

ADVERTISEMENT RATES

Display Rates
 £15.00 per single
 Column Centimetre
 Minimum 5cm x 1col
 One Insertion : £15.00 per scc
 Three Insertions : £14.25 per scc
 Six Insertions : £14.00 per scc
 Nine Insertions : £13.50 per scc
 Twelve Insertions : £13.00 per scc

Micro Ads.
 Linage 25p per
 word minimum of
 15 words.
 Prepayable.

Copy Date

Shopwindow advertisements for the edition will be accepted up to 20th April for June edition, subject to space being available.
 Post to
 Practical Computing, Classified
 Department, Room H211, Quadrant House,
 The Quadrant, Sutton, Surrey SM2 5AS.

IS YOUR MAINS BUGGING YOU?

Mains-borne interference causes annoying data corruption and program crashes. Voltage spikes and power surges can cause permanent damage. Protect YOUR equipment:-

PROTECT-ADAPTA with 3 13Amp sockets, absorbs power-line spikes and surges. £13.95 for 1st, £9.95 for 2nd. (p&p 85p)

4-WAY SUPPRESSOR UNIT (13A) with 4 sockets, spike absorber and suppressors. £23.95 for 1st, £19.95 for 2nd. (p&p £1.50)

PROFESSIONAL SUPPRESSOR UNIT(3A) Multi-stage filter networks, high power spike absorbers, and earth-line choke — the best! £34.95 for 1st, £29.95 for 2nd. (p&p £2)

All units to BS613, also for hi-fi, videos, office equip. etc.

VAX Co. Hogarth House(F), Porchester Rd., Nottingham. NG3 6LE 30

• Circle No. 200



DIGITAL DRAWINGS is C.A.D. using the BBC microcomputer and a dot-matrix printer. A powerful but easy single-key mnemonic commands, drawing storage on disc or cassette, accurate scale drawings to almost any scale, arcs, circles, dimensioning, grids, hatching, ellipses, polygons, rectangles, curve-splining, macros, symbols, text, shading, measurement, repetition, etc. 68-page user guide, available on disc: £75; EPROM: £95; or cassette: £65



3-D VIEW allows wire-frame perspectives to be generated, viewed from any angle of distance, saved on disc or cassette, and printed using a dot-matrix printer. View displayed while entering data. Unlimited viewpoints. Available on disc: £35; or cassette: £30

Now available for Walters WM80 as well as Epson, Star and NEC printers: state printer make & model and media & filing system with order or write for more details. Add £2.00 p&p and VAT. Price rise 1st June — write now to **IBBOTSONS DESIGN SOFTWARE "The Byre"** Ecclesbourne Lane Idridgehay Derbyshire DE4 4JB

• Circle No. 201

PCALC—The Spreadsheet for the NEC PC-8201A, Olivetti M109 Tandy 100.

Now your portable computer can be a complete system — with PCALC, a powerful spreadsheet program specially designed to make the most of your NEC PC-8021A, Tandy Model 100 or Olivetti M-10 (16K RAM required). Supplied on cassette, complete with an easy-to-understand manual. Priced at only £25.00, PCALC is the low cost alternative to expensive ROM based software.

CAPRA-CINDERSTAN ASSOCIATES
 5 OLIVER COURT
 SOUTH HILL PARK GARDENS
 HAMPSTEAD, LONDON NW3 2TE 28

• Circle No. 202

SCIENTIFIC SUBROUTINE LIBRARY

VOLUME 1 — STATISTICS AND FITTING FUNCTIONS

Mean, SD, normal distribution, partial expectation, Chauvenets criterion, least squares fit to polynomial and arbitrary function, repetitive least squares fits, covariance matrix, chi-squared statistic, matrix inversion, solution of simultaneous equations.

VOLUME 2 — LINEAR PROGRAMMING
 Reduction of a Simplex tableau, integer programming, partial integer programming, conversational linear programming system, least cost mix problem.

VOLUME 3 — FURTHER STATISTICS
 Ranking, quantiles, frequency, 2-way table, correlation coefficient, T, chi-squared and F distributions and their inverses, T test, chi-squared test, Wilcoxon test, linear and multiple regression, ANOVA 1-way and 2-way.

VOLUME 4 — TRANSFORMATIONS & SORTING ALGORITHMS
 Fourier, FFT, Laplace, numerical integration and differentiation. Exchange sort, Quicksort, Shell sort, Tree sort.

Manuals including full source listings with implementation notes and documentation —

BASIC £25 per volume

PASCAL £30 per volume

Software in CP/M (8" SSSD) or DEC RT-11 (RXOI) formats — £75 + VAT per volume.

CP/M TO DEC FILE TRANSFER

Software to read and write RT11 format RXOI diskettes under CP/M. Supplied on 8" SSSD diskette — £25 + VAT.

MICRO LOGIC CONSULTANTS LTD.
 57, Station Rd., Southwater, Horsham, W. Sussex.

Telephone: 0403 731818 12

• Circle No. 203

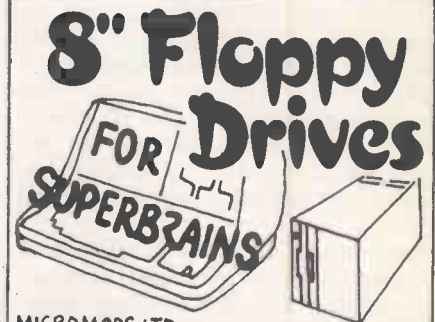

MICROMODS LTD.
 53 ACTON RD LONG EATON NOTTINGHAM
 NG10 1FR TEL: (0602) 724264 31

MicroMods Ltd.

• Circle No. 204

Superbrain Add-ons Spares

Key Tops and Switches
 Keyboard Encoder
 Character Generator
 Complete CRT Assembly
 Keyboard/CPU Complete
 Main Power Supply
 Single & Dble. Sided & Dble. Tracking Disc Drives
 Complete Add-on Boxes: 2 Floppy Drives, Cables & Bios: QD (Double Sided) or DT (Double Tracking) or 8" (IBM Format) plus Cable with female socket
 Winchester Add-on Boxes: 5, 10 or 30 MB



Deane House, 27 Greenwood Place, London NW5 1NN Tel: 01 485 5574. Telex: 264209 29

• Circle No. 205

POOLS PREDICTION "POOLSWINNERS"

The most sophisticated Pools Prediction Aid available. Gives probabilities of score draws, draws, homes or aways, based on two databases holding over 20,000 matches (included).

The databases are automatically updated as results are entered. Can be used in simple mode, or with parameter adjustments to develop your own unique forecast method.

Fully documented, available now for Apple, Spectrum (48K), Dragon, ZX81 (16K), BBC Model B, Commodore 64 (others — please enquire). £15.00 (discs/tapes)

"POOLSDATA"

Complete record of all English Football League matches 1978-83. Teams, scores and dates of 10,000 matches held in simple format, ready for your analysis. Starter analysis programs and full documentation included. Available for Apple, Spectrum, ZX81, BBC, Dragon, Commodore series.

Discs (5 year) £15.00
 Tapes (5 year) £12.50 all prices
 Tapes (2 year) £7.70 (p&p included)

SELEC SOFTWARE (PC)

37 Councilor Lane, Chaddle, Cheshire 061-428 7425 9



• Circle No. 206

The Incredible HULK (£25 + VAT)

HULK is the poor man's knowledge engineer. Knowledge engineering is the new approach to software design which underlies the success of recent knowledge-based expert systems. The HULK package (so called because it Help Uncover Latent Knowledge) offers users of the BBC and Torch microcomputers a low-cost route into knowledge engineering. It will enable you to build up and test a set of decision rules which can be used for prediction or classification. Thus HULK takes the donkey work out of developing a 'knowledge base'. Think of it as a research assistant. This is what the Practical Computing software review said about HULK: "It is very quick and interactive and justifies its name - it does help uncover latent knowledge." "It can genuinely help people to make sound decisions - and bad decision are extremely costly in many enterprises." (March 1984 issue.) HULK is available at £28.75 including VAT for BBC/B (preferably with disks) or Torch microcomputers. We will also make it available for the QL as soon as Uncle Clive lets us have one! Cheque/PO with order from: Warm Boot Limited 40 Bowling Green Lane London EC1R 0NE (Also distributed by Brainstorm Computer Solutions, London N7)

27

• Circle No. 207

HAVE YOU CONSIDERED BAR CODES



Bar-codes give a speedy and error free means of data entry and provide a foolproof method of identification for any item or document. Typical uses include stock control, libraries, filing systems, security & checkpoint verification, point of sale terminals, spare parts identification, etc. etc. Already most grocery products are bar-coded at source and many other areas of industry and commerce are following. Bar-codes will soon be commonplace.

APPLE 2 PET BBC micro

A complete low cost bar-code identification system is available for these micros. It contains all the hardware, software and documentation needed to read and print bar-codes (using an Epson dot matrix printer). Most bar-code formats may be read and the system may easily be patched into an existing applications program.

£199.00 + VAT

***** NEW *** RS232 bar-code reader**
This new stand-alone unit decodes the bar-code and converts it into ASCII for transmission to the host computer via a RS232 port. Complete with scanning wand, power supply & cables. Works with virtually any computer.

£385.00 + VAT

More information on these products is available on request. Please state your micro & area of interest. The decoder board is available separately to OEMs.

DOT MATRIX & DAISYWHEEL PRINTERS LOWEST PRICES GUARANTEED!

EPSON FX80 RX80
NEC 8023 STAR
SHINWA CP80
BROTHER TEC
etc. etc. etc.

Our pricing policy is to match or better any other advertiser. In addition... enthusiastic and knowledgeable technical advice and backup is available to all our customers. Delivery is from stock to your door, often within 24 hours. Phone for a quote or write for full lists.

**ALTEK (PC) 1 GREEN LANE
WALTON ON THAMES SURREY**
please phone before calling
(0932) 244110

17

Every computer needs
CHATTERBOX II
"Listen creep, I am the leader....."

For ZX81
SPECTRUM
BBC
TRS 80
APPLE
NASCOM
VIC/PET/64
(Please state)



NEW! EXCLUSIVE!

PITCH CONTROL

£49 COMPLETE OR £39 (DIY KIT)

CHATTERBOX II can say anything!

Genuine phoneme synthesis - not just recorded speech - hence unlimited vocabulary. Programmable pitch for more natural intonation (exclusive to Wm Stuart Systems) - solid tone cabinet for quality sound - integral beep/music amplifier. PLUS expansion socket for BIG EARS voice recognition system. Full Instructions technical notes and software supplied with this outstanding educational unit. DEALER ENQUIRIES WELCOME

As seen on BBC TV "Computer Programme"
BIG EARS

SPEECH INPUT FOR ANY COMPUTER

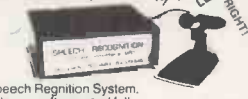

ONLY £49

Hugely successful Speech Recognition System, complete with microphone, software and full Instructions. BUILT TESTED & GUARANTEED. PLEASE STATE COMPUTER: UK101, SPECTRUM, ATOM, NASCOM2, Vic 20, Micron, ZX80/81, PET, TRS80, MZ80K, APPLE II, BBC MICRO

ZX81/SPECTRUM

NEW!

MUSIC SYNTHESISER (Stereo) +16 LINE CONTROL PORT

Play 3-part music, sound effects, drums etc. Full control of attack, decay and frequency. Input/Output lines provide control and monitor facility for Home Security, Robot Control, Model Railway etc. etc. Works with or without 16K RAM.



AMAZING VALUE AT ONLY £19.50 (KIT) £25.50 (BUILT)

Full instructions/software included. Add keyboard to make a live performance polyphonic synthesiser!
Note: up to 3 units can be used simultaneously; giving 9 music channels & 48 I/O lines

S
O
F
T
W
A
R
E

THE COMPOSER

Synthesiser Music Programme. Enter & play 3 part harmony. Includes demonstrations. (Spectrum/ZX81) recommended £7

TALKING HANGMAN

For Chatterbox! The classic game claims its victims with a dry vocal accompaniment (Spectrum) £6

ZX81/DRUMSEQ

Fascinating synthesiser demonstrations. Generates automatic sequences and plays from keyboard. Some wacky effects (Spectrum) £6

CHROMACODE???????

Can you defuse the bomb by cracking the secret combination before time runs out? With Chatterbox voice output (Spectrum) £6

COLOUR MODULATOR

RGB in, PAL/UFH out (not for ZX)

KIT £16 BUILT £22

Please add VAT at 15% to prices. Barclay/Access orders accepted by telephone

All enquiries S.A.E. please

WILLIAM STUART SYSTEMS Ltd

Quarley Down House Cholderton Nr Salisbury Wiltshire, SP4 0DZ
Tel: 098 064 235

• Circle No. 209

compare northern computers... considerate, competitive and committed!

THE Showroom for all the leading micros

- ◆ BBC ◆ Electron ◆ Sinclair ◆ VIC64
- ◆ Dragon ◆ Printers ◆ Disk Drives
- ◆ Plenty of Software
- ◆ Books/Games ◆ Help & Advice
- ◆ Secondhand Computers

Churchfield Rd FRODSHAM Ches. WA6 6RD

northern computers

Telephone: 0988 35110 10 Lines

THE computer centre of the NORTH

• Circle No. 210

SHOP WINDOW

dBASE II - by Ashton Tate is the top selling database package. But it from AQUA Computing Ltd, the dBASE specialists.

dBASE II	£375.00
DBPlus	£125.00
DBFLIST	£30.00
DBAccel	£50.00
dBASE II User' Guide	£22.00
Everyman's Database Primer	£12.00

Any one of the last 4 items is FREE if you buy your copy of dBASE II from AQUA by July 1.

DBPlus COMPRESSES/DECOMPRESSES dBASE II files to 30/40% of original size; SORTS any dBASE II file up to 15 times faster; MODIFIES structures easily - complete with manual. Pays for itself in a few weeks.

Are your files scattered over several disks? **DBFLIST** compiles a master catalogue of all your dBASE files. Can save you hours of searching for that "Lost file".

DBAccel converts dBASE II. CMD file(s) into a single level format for much faster execution; Overlay control can be selective. Program size is limited only by available memory. Reduces running times by up to 50%.

dBASE II User's Guide is one of the best manuals on dBASE II; Has sold over 17,000 copies in the US; Written by Arthur Green, a leading US expert on dBASE courses. In stock now.

dBASE II Beginner's Guide, published by Ashton Tate, is essential for every serious dBASE II user.

For software products (DBASE II, DBPlus, DBFLIST, and DBAccel) add VAT to prices. Specify machine and diskette format (SD/DD, 5.25" or 8"). No extras for packing or postage in UK; add £5.00 for overseas. Further details available on all products. Pay by Cheque, PO, Access or VISA. Send to:

AQUA COMPUTING LTD (Dept PC5), 10 Barley Mow Passage, London W4 4PH (Phone: 01-994 6477).

20

• Circle No. 211

DISKETTES

VERBATIM 5 1/4	VERBATIM 8"
SSDD BOX 10 £21.80	SSDD BOX 10 £30.60
	SSDD BOX 10 £30.90
DSDD BOX 10 £31.00	DSDD BOX 10 £36.10

Prices include delivery but exclude VAT

SPECIAL OFFER - COMPUTER TABLE FOR HOME OR OFFICE. 2 TIER FULLY ADJUSTABLE IN TEAK OAK OR WHITE MELAMINE.

£36.50 + VAT



For full price list phone or write

COBRA

Office & Data Products Ltd., Lichfield House, 21, High Street, Amblecote, Stourbridge, DY8 4DE
Tel: 03843 74880

21

• Circle No. 212

MICROCOMPUTER INSURANCE

Comprehensive cover at a reasonable premium:

- All Risks Cover (incl. Transit) - up to £8,000 for £20
- Increased Cost of Working - to reinstate lost data
- Breakdown & Derangement - alternative to maintenance agreement

Write with details of equipment to:

Geoffrey Hoodless & Associates
Freepost (no stamp required)
Woking
Surrey GU21 3BR
Tel: Woking (04862) 61082 (24 hrs)

14

• Circle No. 213

SHOP WINDOW

Powerful Low Cost CP/M Software

XLT

XLT is a powerful Macro Processor. It can also be used as a cross assembler or language translator. Includes definitions for an 8080 to Z80 translator, and definitions to implement CSAL, a C structured assembly language.....£39.95

Fortran Compiler

Based on ANSI-66 standards with some 1977 level features. Useful TRACE facility. Complete with 174 page documentation, requires 48K RAM.....£29.95

Turbo Pascal

A true Pascal compiler that is extremely FAST and compact. Includes a full screen editor. Requires only 28K disc space. Only.....£49.5 (Available for CP/M-80, CP/M-86 and MSDOS)

CONQUIN SOFTWARE

14 GOODWOOD CLOSE, MORDEN, SURREY, SM4 5AW 36

No callers please Phone 0524 381423

• Circle No. 214

REPAIRS & SERVICE

- * COMPUTERS (Business & Personal)
- * DISC DRIVES (5 1/4 & 8")
- * VDU's
- * MONITORS
- * PRINTERS
- * S100 BOARDS
- * EPROM PROGRAMMING
- * MAINTENANCE CONTACTS

48 hour service for alignment and test of disc drives

A.N. ELECTRONIC & COMPUTER SERVICES LTD

130B North Lane, Aldershot, Hants
Tel: Aldershot (0252) 25608 16

• Circle No. 215

MJ MICRO SUPPLIERS

Disks Wabash - Box of Ten	Dysan - Box of Ten	
SSDD 5.25"	SSDD 5.25"	19.50
SSDD	SSDD	21.50
DSDD	DSDD	21.50
Samsom Date Binder	Disk Storage Box 5"	
9.5" x 12" ea.	1.15 ABA 30/40	16.00
14.5" x 11" ea.	1.22 ABA 60/80	22.00
Listing Paper 2000	Labels 1000	
12" x 8"	13.50 3.5" x 1.5"	4.95
11" x 9.5"	11.95 4" x 1.5"	5.25
11" x 14.5"	14.25 5" x 1.5"	5.50
A4 Clean Edge	24.95	
Printer Ribbons	Scotch Date Cartridge	
Anadex DP9500	7.28 DC300A	19.00
Epson MX/RX/FX80	4.50 DC300A-HD	21.00
Epson MX/FX100	6.95 DC300XL	25.00
MT120/40/60/80	5.25 DC300XL-HD	27.00

Full range of disks, stationery & ribbons available
Prices excl. P&P and VAT.

Cash with order. Add P&P & 15% VAT to prices.

For all your supplies, write for full price list

MJ MICRO SUPPLIES, FREEPOST (BS3661),
Nailsea, BRISTOL BS19 2BR.

No stamp required

Tel: Nailsea (0272) 857354 24 hr. Answer Phone 37

• Circle No. 216

Superbrains

NEW OR
SECOND HAND

WE BUY, SELL
& REFURBISH

MICROMODS LTD.,
53 ACORN RD., LONGEATON, NOTTINGHAM
NG10 1FR. Tel: 0602-724264 32

• Circle No. 217

TELEVIDEO computer TS 802 CP/M twin 400K Disc Drive (64K RAM) plus Epson MX80 FT dot matrix printer for sale only Eighteen Months old pristine condition £1000 o.n.o. Morison 01-876 4646. Ad No.7M

HIGH Quality ICL 1551s Line printer £420 o.n.o. Mr Hedley, Flat 32, Norfolk Walk, W.E.S. Leicester. Ad No.8M

HX-20 EX-RENTAL COMPUTERS

8 - One year old Ex Rental Computers for Sale All in first class order and guaranteed for three months - complete with cassette drives - five rolls of paper - four blank cassettes - Mains Power Supply. List over £480.00 Accept Offers over £300.00

VALLDATA SERVICES LTD
OAKWOOD HOUSE
SPA ROAD
MELKSHAM
WILTSHIRE
SN12 7NP
0225-705957

26

• Circle No. 218

APPLE COMPATIBLE PERIPHERALS

DISK DRIVES

T1 National Panasonic half height drive..... 179.00
T2 As T1, but double sided, twice capacity..... 249.00
HD1 10 MByte hard drive, Basic, CP/M, Pascal... 1095.00

PERIPHERAL CARDS AND EXTRAS - MANY PRICE REDUCTIONS

Four port I/O, twin 6522 card..... 39.50
Printer/buffer card, 32K, graphic dump..... 89.50
A-D card, 16 channel, <100 microsecs conv'n..... 69.00
Clock card, time/date/control intervals..... 49.00
Disc controller card, 13/16 sector..... 32.00
Z80 card, runs all CP/M..... 32.00
ITT2020 version of Z80 card..... 69.50
Printer card, Centronics I/F, inc. cable..... 32.00
RS232 serial card, including cable..... 37.00
16K RAM card, adds 16K, loads Pascal..... 36.00
Eprom writer card, blows most Eproms..... 44.00
80 column card for II plus..... 42.00
80 column card for IIe..... 49.50
80 column card for IIe with extra 64K RAM..... 89.50
80/40 column switch..... 8.50
80 column card inverse video chip..... 6.00
Joystick, 2 control buttons..... 11.95
ASCII encoded keyboard, inc. 1/case, auto repeat.... 49.50
Fan, A.C. operated, keeps your Apple COOL..... 22.95
Monitor, 12" green screen, SANYO..... 69.50
Peanut T-shirt, Tell the World! (state S,M,L)..... 2.95

PRINTERS

Shinwa CP80, 80 cps, top print quality..... 192.00
Star Gemini 10X, fast 120 cps..... 210.00
Peanut KGP40, 40 column, 2 colour, inc. I/F card... 115.00

NEW PEANUT PC2000 BUSINESS/EDUCATIONAL COMPUTER PEANUT present their new top specification computer with full features: twin disk drives, three microprocessors, 64K RAM expandable to 192K. Standard I/F included: RGB monitor, PAL monitor, monochrome monitor, Centronics printer, Serial RS232. Languages: Basic, Pascal, CP/M, Forth, Logo, etc., available.
Upgradeable with all standard Apple peripherals.
Enquire for full details..... 795.00

Carriage: under £100 add £3; over £100 add £5;
Printers/monitors add £7
VAT add 15% MONEY BACK GUARANTEE

PEANUT COMPUTER

Unit 22C, Low Mill
DEWSBURY WF13 3LX
Tel. (0924) 499366 Ext.C 34

ACCESS WELCOME - SEND FOR CATALOGUE

Free PEANUT T-shirt with all orders over £50. State S,M,L.

• Circle No. 219

PRINTER - Professional Anadex DP9501 with Graphics, Stand, 132 Col., High speed Dot matrix. Used 100 hours. Cost £1000. Best Offer over £600 secures. IEEE 488 to serial interface £80 o.n.o. Phone Les, Ballyronan (064887) 264. Ad No.11M

"HEATHKIT" Paper Tape Reader/Punch Model H10A Unused No reasonable offer refused H. Hobbs Tel. 01-574 4451 Daytime. Ad No.12M

ORIC 48K Texttrix cassette based fast machine code word processor. Menu driven featuring full printer control, screen editor, search, preview, save, load, £6.95. P.J. Wright, Willow House, Landford Wood, Salisbury, SP5 2ES. Ad No.13M

COMPLETE APPLE PACKAGE ONLY £500 Apple II Europlus 64K. One disk drive unit, tilt screen monitor, all leads, some software and books. Recently serviced by main dealer. Phone Mike on 021-643 9898 X.4578. Ad No.14M

MU-ONYX for only £3000 ono offer includes Hazeltine terminal para-port 6x Serial ports 10Mb Hard Disk 12Mb Tape 128Kb RAM CP/M 2.2 Pascal Mt + Wordstar SuperCalc MOBI All manuals S. Mann work 01-928 0372 Home 073 081 4811 MP/M and Moasis available. Ad No.15M

OPEN HOUSE FOR NOVICES AND BEYOND

Choose your time - day or evening
Learn at your own pace on OSBORNE, RAIIR or BBC BASIC, D BASE II, SUPERCALC, WORDSTAR, Graphics
Introductory Course £45
Also evening club

Brochure from:
MICROCOMPUTER ADVISORY CENTRE
Polytechnic of the South Bank
Borough Road,
London SE1 0AA
or ring: 01-928 8989 ext. 2468 23

• Circle No. 220

GRUNDIG KINGSLEY

104 Heaton Road,
Newcastle-upon-Tyne NE6 5HL
Tel: (0632 650653)



R.G.B. MONITOR/TELEVISION

AS SUPPLIED TO EDUCATION AUTHORITIES SPECIFICATION

R.G.B. Inputs (Analogue and Digital Levels) All Models.
1 Volt P.P. Composite Video (Remote Model only)
Teletext Decoder available to plug into Chassis. (Remote Model only) Sound input gives access to Audio Amp.

All Models instantly switch back to Television

12" B.W. Monitor	£70 + VAT
14in. Colour Monitor/Television	£227 + VAT
16in. Colour Monitor/Television	£255 + VAT
16in. Colour Monitor/Remote Television	£295 + VAT
20in. Colour Monitor/Remote Television	£315 + VAT
22in. Colour Monitor/Remote Television	£340 + VAT
26in. Colour Monitor/Remote Television	£380 + VAT
Plug in Teletext Module	£75 + VAT
Connecting Lead	£5 + VAT
Carriage and Insurance	£29.50
4 Year Guarantee Insurance	£29.60

R.G.B. Monitor/TV (Grundig Approved) 35

• Circle No. 221

SHOP WINDOW

COMMODORE 8032-SK built in 12' green monitor, Commodore 8024 printer plus cables. £950 o.n.o. 01-903 3521. Ad No.1M

APPLE IIe system hardware enhancements, loads of good software £1450 (Mr Moss) Tel. 01-253-7611 (Evenings Louth — 604718) Ad No.2M

APPLE IIe 80 col. 128K. Monitor III disc drive Epson FX80 printer grappler + Apple Writer IIe, manuals, books, Utilities and games all £1650. Also mountain music system £175 Tel: (01)267 3077 Ad No.3M

COMMODORE PET Basic 4.00, Toolkit, Games, £300 Telephone 0992-444640 Ad No.4M

APPLE II Europlus 64K system including 16K RAM expansion card, parallel printer card, T.V. modulator, disk drive with controller, paddles and various software £550. Ring Keith 07072-73855 (evenings). Ad No.5M

48K ITT 2020, Disk drive + controller, joy stick, set of Apple soft ROMs and over £100 worth of software, £500. Dewsbury, W. Yorks. Tel 0924-463522. Ad No.6M

APPLICATION software development and checking jobs undertaken at attractive rates. Languages MBasic, CBasic, Fortran, Cobol. Anil Divate, Sumeet, J B Naar. Bombay 400059, India. Ad No. 24M

BBC MODEL B owners, develop your touch typing skills with TYPING TRAINER. Send £1.60 for cassette and instructions to: C. Galbraith, 65 Balfour Court, KILMARNOCK KA3 7TE. Ad No.9M

TRS80 colour computer: Joysticks + Chess, Bustout, Skiing, Colour Cubes, Typing Tutor Cartridges £40 o.n.o. Tel: Bradford 834 667. Ad No.10M

WANTED — Printer for Commodore PET 3032. Any make which works. Tel 01-883 6952. Ad No.16M

APPLE II PLUS and RAMcard £250. Also UK101 lots of software and hardware £100 o.n.o Stevenage 352021 Evenings Ad No.17M

CP/M users library 6000+ items free software, Library index £5.50. SAE details E.M.S. 96 Westgreen Road, Tottenham London N17. Ad No.18M

OLYMPIA DAISYWHEEL PRINTER in perfect Condition, with all accessories, BOLT TYPE, VARIABLE PITCH, 17 C.P.S. 14" carriage, manuals etc. £199.00 Tel: 01-521 7733. Ad No.20M

SANYO MBC-1000 creative computer. Built in 12" high resolution CRT display an 5 1/4" disk drive, as new, genuine reason for sale. £650 o.n.o. Tel: (0272) 875027. Ad No.21M

TELEVIDEO 806 MULTI USER SYSTEM: with two TS800 Terminals (Expandable to Six) System includes a single 5" Floppy disc and a five megabyte winchester disc. Each user terminal runs CP/M and the package includes WORD STAR, MAIL MERGE, SPELL STAR For Word Processing SUPER CALC For Spread Sheet & DBASE 2 for other Database applications. New Price Over £8,500 inclusive of software Expecting £4,750 (plus V.A.T.) Ring Ray Coldrick 0594 562256. Ad No.22M

DISK COPYING SERVICE

Moving data and program files from one machine to another is often made difficult because different manufacturers have adopted different disk format standards.

We can copy your files to and from almost any disk format including CP/M, MSDOS, PCDOS, TRSDOS, ISIS, APPLE, SIRIUS, PDP11, VAX, and IBM.

Disks are normally despatched on the day they are received.

Our charge is £10.00 + disk + VAT. Special prices for quantities and tape to disk transfers.

For more information call us.

GREY MATTER

4 Prigg Meadow, Ashburton, Devon TQ13 7DF. TEL. (0364) 53499 10

When replying to Classified advertisements, readers are recommended to take steps to protect their interests before sending money.

SELL IT WITH

Practical Computing

SHOP WINDOW

MICRO ADS. Order Form

Classified Rates

Linage 25p per word
Minimum 15 words prepayable.

Display Adverts.

Rate per single column
Centimetre: £15.00
Minimum 5 cm
SERIES Discounts
Available on request.
Contact: Claire Notley on
01-661 8163.

Method of Payment

Cheques etc should be made payable to BUSINESS PRESS INTERNATIONAL LTD. and crossed.
I enclose herewith cheque/PO for

£.....

Post to:

Cut out the order form and return together with your remittance to:
Classified Department,
Practical Computing,
Room H211, Quadrant House,
The Quadrant, Sutton,
Surrey SM2 5AS.

Conditions of Acceptance

Micro Ads are accepted from Private readers only and must be submitted on (or a photocopy of) this order form. All Advertisements must be prepaid.

Please insert the following advertisement in Practical Computing				LINAGE	
				Cost per insertions	
				1 Ins.	2 Ins.
				✓	✓
				£3.75	£3.25
				£5.00	£4.50
				£6.25	£5.75
				£7.50	£7.00
				£8.75	£8.25
				£10.00	£9.50
				£11.25	£10.75
				£12.50	£12.00

Box No. Required YES/NO

✓ tick number of insertions required

NAME (Please include initials)

ADDRESS

THIS FORM SHOULD BE RETURNED BY 20TH MARCH FOR THE MAY ISSUE

Company Registered Number: 151537 (ENGLAND). Registered Office: Quadrant House, The Quadrant, Sutton, Surrey SM2 5AS.

Advertisement Index

A		E		L		R	
A&G Computerware	38	ESS Consultants	43	LVL	144,145	RATA	118
A-Line Computers	30	Eccleston Electronics	176	Ladbroke Hotels	71	Real Time Developments	164
ACT Pulsar	140,141	Epson Printers	74,75	London Comp Centre	24		
ACT Pulsar	52,53			London Computer Fair	173		
ACt/Sirius Apricot	10,11					S	
ATA	39					SCI (UK)	108
Accent	46	F		M		Sagesoft	174
Aculab Ltd	38	Fox & Gellar	4	MEM	124	Saracen Data Products	141
Advance Technology,	34,115	Fraser Associates	110	MPI Ltd	54	Simmons Magee	16
Aimgram Ltd	183	Fujitsu	28	Mayfair Micros	166	Sinclair Research	150,151
Akhter Instruments Ltd	99			Memotech Ltd	66,67,68	Software	BC
Audio Genic	60			Mercator	36	Software 84	70
				Micro Business	32	Software Products Int	40,41
B		G		Micro Miracles	177	Solid State Nutronics	44
BFI/Diskpost	158	GCC Cambridge Ltd	36	Micro Peripherals	18C	Swan Packaging	106,118
Bee Bug	72,106	GW Computers	37	Microcomputer Disks	166	Symbiotic	154
Bromcom	9	Gemini Microcomputers	65	Microfast Ltd	172		
				Micromanagement	178,179	T	
C				Micronix	31	Tandy Corp	149
Calco Software	30	H		Micropute	152,153	Telesystems Ltd	64
Cambridge Micro Elec	164	HM Systems	25	Microsoft	18,19	The Computer Fair	98
Cetronic Components Ltd	118	Handic UK	109	Microvitec	17	Thorn EMI	177
C.K. Computers	33			Microware	61,63	Triumph Adler	82,83
Comart	12			Midland Computer Fair	142,143		
Comcen Tech Ltd	36	I		Mike Lewis	73		
Compec North 84	70	Icarus Comp Systems	6	Mountandene	106	V	
Comsoft	20	Integrax	59			Vector International	139
Computech Systems	1FC	Interam	14	O		Verwood Systems	62
Computer Enterprises	110			Oryx	97		
Computer Park	77					W	
Computer Pro	77	J		P		Worldwide Computers Ltd	72
Cord Designs Ltd	176	Jarogate	22	Page Plus	69		
				Power Testing Sales	121	X	
D				Precision Software	73	X-Data	81
Data Disk (UK) Ltd	186			Psion	73		
Datac	82	K				Z	
Daytron	80	KGB Micros	93	Q		Zero Electronics	
Digital Equip Co	26,27	Kingsley Enterprises	30	Qubie	51		
Disco Technology Ltd	180	Kingsway Data	42	Qume (UK) Ltd	76,77		
Disking International	174,175						
Duplex Comm Ltd	38						

DATA DISK (U.K.) LTD.

3 Peartree Business Centre
Peartree Road
Stanway Colchester Essex
0787 210091

COMPARE OUR PRICES PRINTERS

The New "JUKI" 6100 Daisywheel
(RRP £499 + VAT)

MT80
(RRP £265 + VAT)
UCHIDA
(RRP £399 + VAT)

JUST ARRIVED

Our own brand of covers
for the Commodore 20, 64 &
the B.B.C./V computer £3.95
+ VAT Colours black or beige.

Floppy Disks by CONTROL DATA

5 1/4" Single Sided/Single Density } £15.00 for 10 + VAT
Single Sided/Double Density }
Double Sided/Double Density = £19.50 for 10 + VAT
8" Disks and Quad Density also available
5 1/4" Plastic Library Cases £2.75 + VAT each

NEW FROM FRANCE!

LIBRARY CASES IN BROWN/CREAM.

5 1/4" 20-Capacity = £2.80 + VAT
Lockable Filing Cases with carrying handle Brown/Cream
for 5 1/4" disks x 100 capacity ONLY £18.50 + VAT

Other lockable filing cases:

5 1/4" 40-Capacity = £15.50 + VAT
5 1/4" 90-Capacity = £21.95 + VAT
8" 40-Capacity = £22.95 + VAT
8" 90-Capacity = £31.95 + VAT

The small Company
with the big name
in consumables

Contact us for all your computer needs. Anything from
ribbons, listing paper, labels, disks, printers etc. etc.

Everything on mail order, enquire for our comprehensive
price lists.

Free delivery on all printers and disks

Nominal charge for all other ranges.

EPSON FX80 OUR PRICE
(RRP £438.00 + VAT) ONLY £425.00 including VAT.
"Free Delivery" No Extras.

EPSON RX-80 OUR PRICE
(RRP £298.00 + VAT) ONLY £285.00 including VAT
"Free Delivery" No Extras

EPSON RX-80 FP OUR PRICE
 ONLY £315.00 including VAT
"Free Delivery" No Extras.

OKI MICROLINE 83a = £525.00 including VAT
OKI MICROLINE 80a = £225.00 including VAT.

LISTING PAPER

11" x 9 1/2" Single pt = £8.50 + VAT per box 2000
11" x 14 1/2" Single pt = £11.50 + VAT per box 2000
All other sizes available. Either plain or green lined.

To Data Disk (UK) Ltd.

Please Supply
Please Supply
Please Supply
Please Supply
Enclosed my cheque/money order Total
Delivery to:- (Name)
Address

Telephone No

Trade and Dealer Enquiries Welcomed. More Agents Urgently
Needed Nationwide.

JUKI

The Art of Daisywheel Printing



The new Juki Model 6100 letter quality daisy wheel printer, has full features you'd expect to find on a more expensive printer.

It can support word processing and graphic functions, print 20 CPS and use a simple drop-in daisy wheel.

The 6100 has 10/12/15 pitch, proportional spacing, utilizes IBM standard Selectric ribbons, has 2K buffer memory, parallel interface both tractor feed and serial interface are available as options.

That's only the beginning - Best of all, the low-noise Juki 6100 is extremely reliable.

Your can pay more, but you can't buy better than the Juki 6100.

FEATURES:

- *20 CPS (max.) print speed
- *Bold and shadow printing
- *Subscripts and superscripts
- *Wordstar compatible
- *Diablo protocols
- *Auto Underlining
- *Standard 2K buffer
- *1 year parts and labour warranty
- *Comprehensive user friendly manual

MP **Micro Peripherals Ltd**

'THE POWER BEHIND THE PRINTED WORD'

69 The Street, Basing, Basingstoke, Hampshire RG24 0BY
Telephone: 0256 3232 (12 lines) Telex: 859669 MICROP G

Call your local dealer NOW for full information on the Juki 6100 Daisywheel Printer or clip this coupon and we'll send you brochures and print samples.

Name.....

Address.....

.....

Tel. No..... 187

**Just because you
need it in a flash,
don't expose
yourself!**



You've a deadline to meet, the right CP/M Software package is needed, the right decision has to be made; which format, which product, when can it be delivered, at what price?

You need good advice, and just as important, you need to talk to someone who has a large enough range to be able to offer honest advice. Someone who can then deliver on time, someone whose catalogue is fast becoming the byword of the software industry.

So don't expose yourself, talk to Software Limited. Choice, advice and delivery, all aimed at meeting your deadline.

Software Limited...
Because there's more to choose from, we're the only choice to make.

01-833 1173/6

Software Limited
No. 2 Alice Owen Technology Centre
251 Goswell Road, London EC1

CP/M is a trademark of Digital Research



Attractive quantity & dealer discounts available

188

● Circle No. 252